

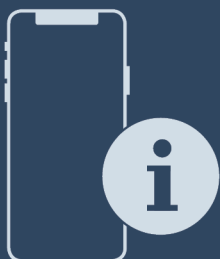

User Guide

Quality, Design and Innovation





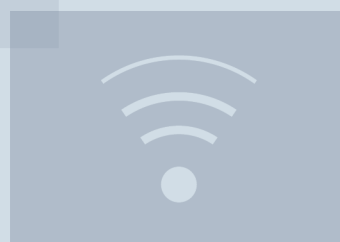
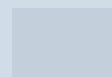













[home.liebherr.com/fridge-manuals](http://home.liebherr.com/fridge-manuals)









# LIEBHERR

# Contents

<b>1</b>	<b>General safety instructions</b> .....	<b>3</b>
<b>2</b>	<b>Appliance at a glance</b> .....	<b>4</b>
2.1	Scope of delivery.....	4
2.2	Overview of appliances and equipment.....	4
2.3	SmartDevice.....	4
2.4	Appliance range of use.....	5
2.5	Conformity.....	5
2.6	Spare parts.....	5
<b>3</b>	<b>Functionality of the Touch display</b> .....	<b>5</b>
3.1	Navigation and symbol explanation.....	5
3.2	Menus.....	6
3.3	Sleep mode.....	6
<b>4</b>	<b>Putting into operation</b> .....	<b>6</b>
4.1	Switching on appliance (first use).....	6
4.2	Starting the EasyTwist-Ice for the first time.....	7
<b>5</b>	<b>Storage</b> .....	<b>7</b>
5.1	Information regarding storage.....	7
5.2	Freezer compartment.....	7
5.3	Storage times.....	8
<b>6</b>	<b>Saving energy</b> .....	<b>8</b>
<b>7</b>	<b>Controls</b> .....	<b>8</b>
7.1	Controls and displays.....	8
7.1.1	Status display.....	8
7.1.2	Display symbols.....	8
7.2	Appliance functions.....	8
7.2.1	Notes on the appliance functions.....	8
	Switching the appliance off and on.....	8
	WiFi.....	9
	Temperature.....	10
	Temperature unit.....	10
	SuperFrost.....	10
	Start defrosting cycle.....	11
	PartyMode .....	11
	SabbathMode.....	12
	E-Saver .....	12
	Display brightness.....	13
	Door alarm.....	13
	Input lock.....	13
	Device information.....	14
	Software.....	14
	Demo mode.....	14
	Resetting to factory settings.....	15
7.3	Messages.....	15

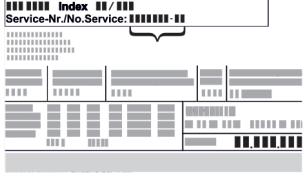
7.3.1	Overview of warnings.....	15
7.3.2	Ending warnings.....	15
7.3.3	Overview of reminders.....	16
<b>8</b>	<b>Features</b> .....	<b>16</b>
8.1	Drawers.....	16
8.2	EasyTwist-Ice.....	17
8.3	VarioSpace.....	18
<b>9</b>	<b>Maintenance</b> .....	<b>18</b>
9.1	Disassembling / assembling pull-out systems.....	18
9.2	Defrosting the appliance.....	19
9.3	Cleaning the appliance.....	19
<b>10</b>	<b>Customer help</b> .....	<b>21</b>
10.1	Technical specifications.....	21
10.2	Operating noises.....	21
10.3	Technical fault.....	22
10.4	Customer Service.....	23
10.5	Model plate.....	23
<b>11</b>	<b>Shutting down</b> .....	<b>23</b>
<b>12</b>	<b>Disposal</b> .....	<b>23</b>
12.1	Preparing appliance for disposal.....	23
12.2	Disposing of the appliance in an environmentally friendly manner.....	24

The manufacturer is continually working on the further development of all types and models. Please be aware that we reserve the right to make changes to the shape, equipment and technology.

Symbol	Explanation
	<b>Read instructions</b> Please read the information in these instructions carefully to understand all of the benefits of your new appliance.
	<b>Additional information on the Internet</b> The digital manual with additional information can be found via the QR code on the front of the manual or by entering the service number at <a href="http://home.liebherr.com/fridge-manuals">home.liebherr.com/fridge-manuals</a> . The service number can be found on the serial tag:  <i>Fig. Example illustration</i>
	<b>Check appliance</b> Check all parts for transport damage. If you have any complaints, please contact your agent or customer service.
	<b>Differences</b> These instructions apply to a range of models, so differences are possible. Sections that apply to certain models only are marked with an asterisk (*).
	<b>Instructions and results</b> Instructions are marked with a ▶. Results are marked with a ▷.

Symbol	Explanation
	<b>Videos</b> Videos about the appliances are available on the YouTube channels of Liebherr-Hausgeräte.

## Open source licences:

The appliance contains software components that use open source licences. Information on the open source licences used can be found here: [home.liebherr.com/open-source-licences](https://home.liebherr.com/open-source-licences)

These operating instructions apply to:

SFN..	52..
-------	------

## Note

If your appliance has an N in its appliance designation, it is a NoFrost appliance.

## 1 General safety instructions

Please keep these instructions in a safe place and pass them on to any subsequent owners.

Read these operating instructions carefully before use to ensure safe and correct use of the appliance. Follow the instructions, safety instructions and warning messages included at all times. They are important for ensuring you can operate and install the appliance safely and without any problems.

### Danger for the user:

- This device can be used by children and people with impaired physical, sensory or mental abilities or with a lack of experience and knowledge provided that they are supervised or have received instruction in the safe use of this device, and about the resulting hazards. Children must not play with this appliance. Cleaning and user maintenance work must not be carried out by children without adult supervision. Children aged between 3 and 8 are allowed to load and unload the appliance. Children below the age of 3 must be kept away from the appliance unless they are under continuous adult supervision.
- The socket must be easily accessible so that the appliance can be disconnected quickly from the electricity in an emergency. It must not be located in the area behind the appliance.
- When disconnecting the appliance from the supply, always take hold of the plug. Do not pull the cable.
- In the event of a fault pull out the mains plug or deactivate the fuse.
- Do not damage the mains power cable. Do not operate the appliance with a defective mains power cable.
- If the supply cord is damaged, it must be replaced by a special cord or assembly available from the manufacturer or its service agent.
- Only customer service or other specially trained staff may repair or perform other operations on the appliance.
- Only assemble, connect and dispose of the appliance according to the instructions.
- Special lights, such as LED lights on the appliance, are used to illuminate the interior of the appliance and are not suitable for room lighting.

### Fire hazard:

- This appliance contains a refrigerant which is environmentally friendly, but flammable. Leaking refrigerant may ignite. It is hazardous for anyone other than an Authorised Service Person to service this appliance. In Queensland, the authorised Service Person MUST hold a Gas Work Authorisation for hydrocarbon refrigerants, to carry

out Servicing or repairs where the gas system is being opened or charged.

- The coolant used (information on the model plate) is ecofriendly but also flammable. Any leaking coolant may ignite.
  - Do not damage the refrigerant circuit pipes.
  - Do not handle ignition sources inside the appliance.
  - Do not use electrical appliances inside the appliance (e.g. steam cleaners, heaters, ice cream makers, etc.).
  - If the refrigerant leaks: remove any naked flames or ignition sources from the vicinity of the leakage point. Properly air the room. Inform customer services.
- Do not store explosives or sprays using combustible propellants such as butane, propane, pentane, etc. in the appliance. To identify these spray cans, look for the list of contents printed on the can, or a flame symbol. Gases possibly escaping may ignite due to electrical components.
- Keep burning candles, lamps and other items with naked flames away from the appliance so that they do not set the appliance on fire.
- **WARNING:** Keep ventilation openings, in the appliance enclosure or in the built-in structure, clear of obstruction.
- **WARNING:** Do not use mechanical devices or other means to accelerate the defrosting process, other than those recommended by the manufacturer.
- **WARNING:** Do not damage the refrigerant circuit.
- Please be sure to store alcoholic drinks or other packaging containing alcohol in tightly closed containers. Any alcohol that leaks out may be ignited by electrical components.

### Danger of tipping and falling:

- Do not misuse the plinth, drawers, doors etc. as a step or for support. This applies particularly to children.

### Danger of food poisoning:

- Do not consume food which has been stored too long.

### Danger of frostbite, numbness and pain:

- Avoid prolonged skin contact with cold surfaces or refrigerated/frozen goods or take protective measures, e.g. wear gloves.
- Do not consume ice cream, water ice or ice cubes immediately and do not consume them too cold.

### Danger of injury and damage:

- Hot steam can lead to injury. Do not use electrical heating or steam cleaning equipment, open flames or defrosting sprays to defrost.
- Do not use sharp implements to remove the ice.

### Risk of crushing:

- Do not hold the hinge when opening and closing the door. Fingers may get caught.

### Symbols on the appliance:



This symbol may be located on the compressor. It relates to the oil in the compressor and makes reference to the risk that: Swallowing or inhaling can be fatal. This advice is only relevant to recycling. There is no danger in normal operation.



This symbol is located on the compressor and indicates the danger of flammable materials. Do not remove the sticker.

## Appliance at a glance



This or a similar sticker may be located on the rear of the appliance. This sticker indicates that there are vacuum insulation panels (VIP) or perlite panels in the door and/or housing. This advice is only relevant to recycling. Do not remove the sticker.

Please note the warning messages and other specific advice in the other chapters:

	DANGER	indicates an immediately hazardous situation which will lead to death or serious injuries if it is not avoided.
	WARNING	indicates a hazardous situation which may lead to death or serious injuries if it is not avoided.
	CAUTION	indicates a hazardous situation which may lead to minor or moderate injuries if it is not avoided.
	NOTICE	indicates a hazardous situation which may lead to damage to property if it is not avoided.
	Note	indicates useful instructions and tips.

## 2 Appliance at a glance

### 2.1 Scope of delivery

Check all parts for transport damage. Contact your dealer or customer service in the event of complaints. (see 10.4 Customer Service)

Your new appliance comes with the following parts:

- Standalone appliance
- Features (depending on the model)
- Installation materials (depending on the model)
- "Quick Start Guide"
- "Installation Guide"

### 2.2 Overview of appliances and equipment

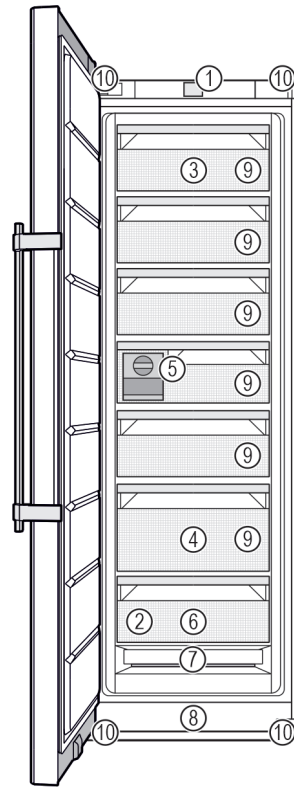

Fig. 1 Example illustration

- |                           |  |
|---------------------------|--|
| <b>(1)</b> Controls       | <b>(6)</b> Freezer tray  |
| <b>(2)</b> Type plate     | <b>(7)</b> NoFrost   |
| <b>(3)</b> Tilting drawer | <b>(8)</b> Ventilation slit  |
| <b>(4)</b> SpaceBox       | <b>(9)</b> VarioSpace  |
| <b>(5)</b> EasyTwist-Ice  | <b>(10)</b> Adjustable feet (front),<br>transport castors (rear),<br>transport handles at the<br>top (rear) and at the<br>bottom (front) |

### 2.3 SmartDevice

SmartDevice is the networking solution for your freezer. If your appliance SmartDevice-enabled or compatible, you can quickly and easily connect your appliance to your WiFi. With the SmartDevice app, you can operate your appliance from a mobile device. Additional functions and setting options are available in the SmartDevice SmartDevice app.

SmartDevice-compatible appliance:

Your appliance is compatible for use with the SmartDeviceBox. You must first purchase and install the SmartDeviceBox. In order to connect your appliance to the WiFi, you need to download the SmartDevice app.

More information about SmartDevice:

[smartdevice.liebherr.com](http://smartdevice.liebherr.com)

Purchasing the SmartDeviceBox in the Liebherr-Hausgeräte store:

[home.liebherr.com/shop/de/deu/smartdevicebox.html](http://home.liebherr.com/shop/de/deu/smartdevicebox.html)

Downloading the SmartDevice app:



After installing and configuring the SmartDevice app, you can connect your appliance to your Wi-Fi (see WiFi) using the SmartDevice app and the appliance's Wi-Fi function.

## Note

The SmartDevice function is not available in the following countries: Russia, Belarus, Kazakhstan.

You cannot use the SmartDeviceBox.

## 2.4 Appliance range of use

### Intended use

The appliance is only suitable for cooling food products in a domestic or household-like environment. This includes, for example, use:

- in staff kitchens, bed and breakfast establishments,
- by guests in country houses, hotels, motels and other accommodation,
- for catering and similar services in the wholesale trade.

The appliance is not suitable as a built-in unit.

All other types of use are not permitted.

### Foreseeable misuse

The following applications are expressly forbidden:

- Storing and refrigerating medicines, blood plasma, laboratory preparations or similar substances and products based on the Medical Device Directive 2007/47/EC
- Use in outdoor areas with very high humidity
- Use in areas at risk of explosions

Misusing the appliance may lead to damage to the goods stored or they may spoil.

### Climate classifications

Depending on the climate classification the appliance is designed to operate in restricted ambient temperatures. The climate classification applying to your appliance is printed on the rating plate.

## Note

- Keep to the specified ambient temperatures in order to guarantee that the appliance works properly.

Climate classification	for ambient temperatures of
SN	10 °C to 32 °C
N	16 °C to 32 °C
ST	16 °C to 38 °C
T	16 °C to 43 °C
SN-ST	10 °C to 38 °C
SN-T	10 °C to 43 °C

If your appliance does not have a fixed water connection, then the appliance is guaranteed to function correctly down to a lower ambient temperature of -15 °C.

## 2.5 Conformity

The refrigerant circuit has been tested for leaks. The appliance complies with the applicable safety regulations and with the corresponding directives.

The full text of the EU Declaration of Conformity is available on the following website: [www.Liebherr.com](http://www.Liebherr.com)

## 2.6 Spare parts

The spare parts availability for functional parts and stockable parts of the equipment is 15 years.

## 3 Functionality of the Touch display

You operate your appliance using the Touch display. You select appliance functions in the Touch display (hereafter referred to as display) by tapping them. If you do not perform any action on the display for 10 seconds, the display either jumps back to the higher-level menu or directly to the status display.

### 3.1 Navigation and symbol explanation

In the illustrations, different symbols are used to navigate the display. The following table describes these symbols.

Symbol	Description
	<b>Press the Next navigation arrow:</b> Navigates to the next option in the menu.
	<b>Press the Back navigation arrow:</b> Jumps back one option in the menu.
	<b>Press the navigation arrow several times in succession:</b> Navigates in the menu to the desired function.
	<b>Press the Confirm symbol:</b> Activates/deactivates function. Opens submenu.
	<b>Press the Confirm symbol together with the back icon:</b> Jumps back one menu level.
	<b>Arrow with clock:</b> It takes more than 10 seconds for the following message to appear in the display.
	<b>Arrow with a time indication:</b> It takes the specified amount of time until the following message appears in the display.

# Putting into operation

Symbol	Description
	<p><b>“Open Settings menu” symbol:</b>                      Navigates to the Settings menu and opens the settings menu.                      If necessary: Navigate to the desired function in the Settings menu.                      (see 3.2.1 Opening the Settings menu)</p>
	<p><b>“Open Advanced menu” symbol:</b>                      Navigates to the Advanced menu and opens the advanced menu.                      If necessary: Navigate to the desired function in the Advanced menu.                      (see 3.2.2 Opening the Advanced menu)</p>
No action for 10 seconds	If you do not perform any action on the display for 10 seconds, the display either jumps back to the higher-level menu or directly to the status display.
Close the door and open it again.	If you close the door and immediately open it again, the display jumps directly back to the status display.

Note: Illustrations of the display are shown in the English version.

## 3.2 Menus

The appliance functions can be found in various menus.

Menu	Description
Main menu	When you switch the appliance on, you are automatically in the main menu. From here you can navigate to the most important appliance functions, to the Settings menu and to the Advanced menu.
 Settings menu	The Settings menu contains additional appliance functions for setting up your appliance. (see 3.2.1 Opening the Settings menu)
Advanced menu	The advanced menu contains special appliance functions for setting up your appliance. Access to the Advanced menu is protected by the numerical code <b>1 5 1</b> . (see 3.2.2 Opening the Advanced menu)

### 3.2.1 Opening the Settings menu

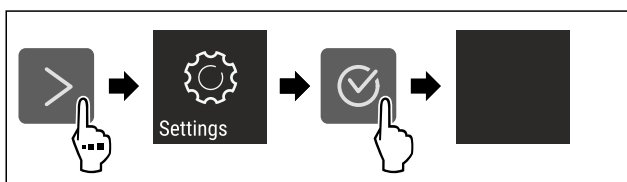

Fig. 2 Example illustration

- ▶ Carry out action steps according to the illustration.
- ▶ Settings menu is open.
- ▶ If necessary: Navigate to the desired function.

### 3.2.2 Opening the Advanced menu

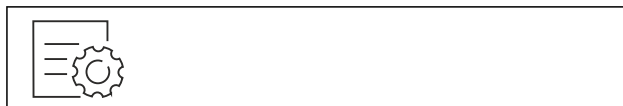

Fig. 3

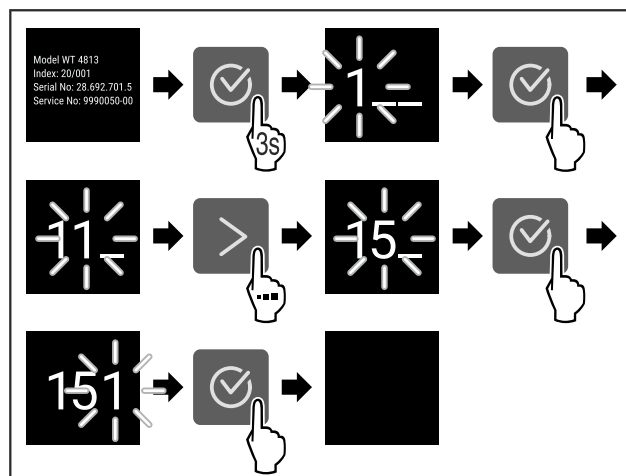

Fig. 4 Example illustration, access with numerical code **151**

- ▶ Carry out action steps according to the illustration.
- ▶ The expanded menu is open.
- ▶ If necessary: Navigate to the desired function.

## 3.3 Sleep mode

If you do not touch the display for 1 minute, the display switches to sleep mode. In sleep mode, the display brightness is dimmed.

### 3.3.1 Ending sleep mode

- ▶ Press any navigation key.
- ▶ Sleep mode is ended.

## 4 Putting into operation

### 4.1 Switching on appliance (first use)

Make sure that the following requirements are fulfilled:

- The appliance has been installed and connected in accordance with the installation instructions.
- All adhesive strips, adhesive and protective films and transport locks are removed from inside and on the appliance.
- All marketing leaflets are removed from the drawers.
- You are familiar with the functionality of the Touch display. (see 3 Functionality of the Touch display)

#### Switch on the appliance using the Touch display:

- ▶ If the display is in sleep mode: Press the confirmation symbol.
- ▶ Carry out action steps according to the illustration.

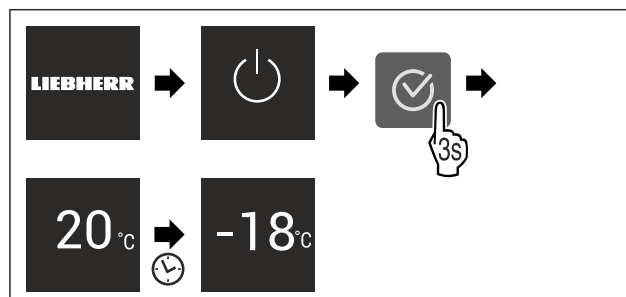

Fig. 5 Example illustration

- ▶ Status display appears.
- ▶ The appliance cools to the temperature set at the factory.
- ▶ The appliance starts in demo mode (status display with DEMO appears): If the appliance starts in demo mode, you can deactivate demo mode within the next 5 minutes. (see Demo mode)

**More information:**

- Start the EasyTwist-Ice for the first time. (see 4.2 Starting the EasyTwist-Ice for the first time)
- Start the SmartDevice for the first time. (see 2.3 Smart-Device) and (see WiFi)

**Note**

The manufacturer recommends:

- ▶ **Store frozen foods** at -18 °C or colder.
- ▶ Observe the notes on storing food. (see 5.1 Information regarding storage)

**Note**

Accessories can be purchased from the Liebherr-Hausgeräte store at [home.liebherr.com/shop/de/deu/zubehor.html](http://home.liebherr.com/shop/de/deu/zubehor.html).

## 4.2 Starting the EasyTwist-Ice for the first time

If your appliance is equipped with EasyTwist-Ice, you must clean the EasyTwist-Ice **before using it for the first time**.

Make sure that the following requirements are fulfilled:

- The appliance is properly connected.
- ▶ Clean the EasyTwist-Ice. (see 9.3.5 Cleaning the EasyTwist-Ice)
- ▶ Fill the water tank. (see Filling the water tank)

## 5 Storage

### 5.1 Information regarding storage



**WARNING**

Fire hazard from electrical appliances!

If you use electrical appliances in the food area of your appliance, they can cause a fire.

- ▶ Do not use electrical appliances in the food area of the appliance unless recommended by the manufacturer.

**Note**

The energy consumption increases and the cooling power goes down if ventilation is not sufficient.

- ▶ Always keep air slots clear.

Observe the following specifications for storage:

- Keep the air vents on the fan free.
- Package food properly.
- Package raw meat or fish in clean, closed containers. This will prevent meat or fish from touching or dripping onto other food.
- Leave space between goods to ensure good air circulation.
- Store food according to the instructions on the packaging.
- Always observe the best-before date indicated on the packaging.

**Note**

Failure to follow these guidelines can lead to foodstuffs spoiling.

## 5.2 Freezer compartment

Here, a dry, frosty storage climate is created at -18 °C. A frosty storage climate is suitable for storing frozen food for several months, for making ice cubes or freezing fresh food.

### 5.2.1 Freezing food

**Freezing quantity**

The maximum amount of fresh food that you can freeze within 24 hours is specified on the type plate (see 10.5 Model plate) under "Freezing capacity ... kg/24h".

To ensure that food quickly freezes through, adhere to the following quantities per package:

- Fruit and vegetables up to 1 kg
- Meat up to 2.5 kg

**Freezing food using SuperFrost**

Depending on the quantity to be frozen, you can activate SuperFrost before freezing in order to achieve lower freezing temperatures. (see SuperFrost)

- ▶ Activate SuperFrost if the amount of food you have to freeze is more than approx. 2 kg.

The time at which you activate SuperFrost depends on the amount of food you have to freeze:

Freezing quantity	Time at which you should activate SuperFrost
Small amount of food to freeze	Activate SuperFrost about 6 hours before freezing. As soon as the appliance automatically deactivates SuperFrost, you can rearrange the food.
Maximum amount of food to freeze	Activate SuperFrost about 24 hours before freezing. As soon as the appliance automatically deactivates SuperFrost, you can rearrange the food.

**Arranging your food properly**



**CAUTION**

Risk of injury from broken glass!

Bottles and cans with beverages can burst during freezing. This applies in particular to carbonated beverages.

- ▶ Only freeze bottles and cans with beverages if you have activated the BottleTimer function in the SmartDevice app.

Freezing quantity	Arranging your food properly
Small amount of food to freeze	Place packaged food in the top drawer. If possible, place groceries at the back of the drawer near the rear wall.
Maximum amount of food to freeze	Distribute packaged groceries throughout all drawers, but only place frozen food in the bottom drawer. If possible, place groceries at the back of the drawer near the rear wall.

# Saving energy

## 5.2.2 Defrosting food



### WARNING

Risk of food poisoning!

- ▶ Do not re-freeze thawed food.
- ▶ Use defrosted foodstuff as soon as possible.

You can defrost food in several ways:

- In a fridge
- In the microwave
- In the oven/fan-assisted oven
- At room temperature
- ▶ Take out only as much food as necessary.

## 5.2.3 Freezer tray

You can freeze berries, herbs, vegetables and other small frozen food in the freezer tray without it all freezing together. The frozen food is less likely to get squashed and subsequent portioning is easier.

- ▶ Distribute food on the freezer tray without packaging and well spaced out.

## 5.3 Storage times

Refer to the specified storage times as a guide.

In the case of foods with a minimum shelf life, the date indicated on the packaging still applies.

Recommended storage period for various types of food		
Ice cream	at -18 °C	2 to 6 months
Sausages, ham	at -18 °C	2 to 3 months
Bread, baked goods	at -18 °C	2 to 6 months
Game, pork	at -18 °C	6 to 9 months
Fatty fish	at -18 °C	2 to 6 months
Lean fish	at -18 °C	6 to 8 months
Cheese	at -18 °C	2 to 6 months
Poultry, beef	at -18 °C	6 to 12 months
Vegetables, fruit	at -18 °C	6 to 12 months

## 6 Saving energy

- Pay attention to good ventilation. Do not cover ventilation holes or grids.
- Always keep the fan air slits clear.
- Do not place the appliance in direct sunlight or near radiators or similar sources of heat.
- If the appliance is placed directly next to an oven, the energy consumption may increase slightly. This is dependent on the service life and usage intensity of the oven.
- Energy consumption depends on the installation conditions, e.g. the ambient temperature (see 2.4 Appliance range of use) . A warmer ambient temperature can increase the energy consumption.
- Open the appliance for as short a time as possible.
- The lower the temperature is set the higher the energy consumption.
- Keep all food properly packed and covered. This prevents frost from forming.
- Inserting warm food: allow to cool down to room temperature first.

## 7 Controls

### 7.1 Controls and displays

#### 7.1.1 Status display



Fig. 6

##### (1) Temperature display

The Status display shows the set temperature and is the home display. From there, you can navigate to the options and settings.

#### 7.1.2 Display symbols

Display symbols provide information on the current appliance status:

Symbol	Appliance status
	<b>Standby</b> The appliance or temperature zone is switched off.
	<b>Flashing number</b> Appliance is working. Temperature flashes until the set value is reached.
	<b>Flashing symbol</b> Appliance is working. Setting is made.
	<b>Bar grows steadily</b> Function is activated.

### 7.2 Appliance functions

#### 7.2.1 Notes on the appliance functions

The appliance functions are set at the factory so that your appliance is fully functional.

Before you alter, activate or deactivate the device functions, make sure that the following requirements are met:

- You have read and understood the descriptions of how the display works. (see 3 Functionality of the Touch display)
- You have familiarised yourself with the operating and display elements of your appliance.



#### Switching the appliance off and on

Use this function to switch the entire appliance off and on.

##### Switching off the appliance

When you switch the appliance off, then the previously saved settings are saved.

Make sure that the following requirements are fulfilled:

- Handling instructions (see 11 Shutting down) are carried out.

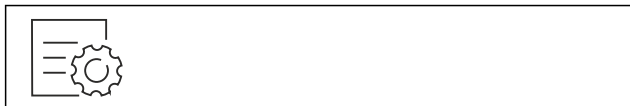

Fig. 7

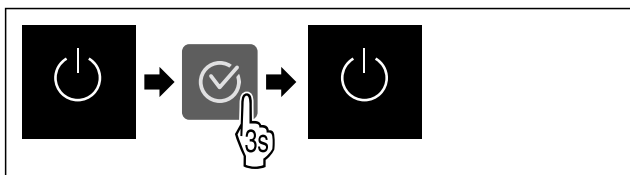

Fig. 8

- ▶ Carry out action steps according to the illustration.
- ▶ Appliance is switched off.
- ▶ The standby symbol appears in the display.
- ▶ Display turns black.

### Switching on the appliance

If the display is in sleep mode:

- ▶ Press any navigation key.

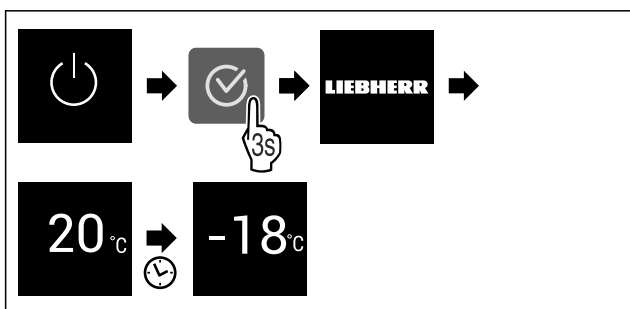

Fig. 9 Example illustration

- ▶ Carry out action steps according to the illustration. When the appliance starts in demo mode:
- ▶ Deactivating demo mode. (see Deactivating demo mode)
- ▶ The appliance is switched on.
- ▶ Previous settings are restored.
- ▶ The appliance cools to the target temperature set.



### WiFi

Use this function to connect your appliance to WiFi. You can then operate it via the SmartDevice app on a mobile device. You can also use this function to disconnect or reset the WiFi connection.

To connect your device to WiFi, you need the SmartDeviceBox.

More information on the SmartDevice: (see 2.3 SmartDevice)

#### Note

The SmartDevice function is not available in the following countries: Russia, Belarus, Kazakhstan.

You cannot use the SmartDeviceBox.

#### Establishing the WiFi connection for the first time

Make sure that the following requirements are fulfilled:

- You have purchased and inserted a SmartDeviceBox. (see 2.3 SmartDevice)
- You have installed the SmartDevice app (see [apps.home.liebherr.com](https://apps.home.liebherr.com)).
- Registration in the SmartDevice app is completed.



Fig. 10

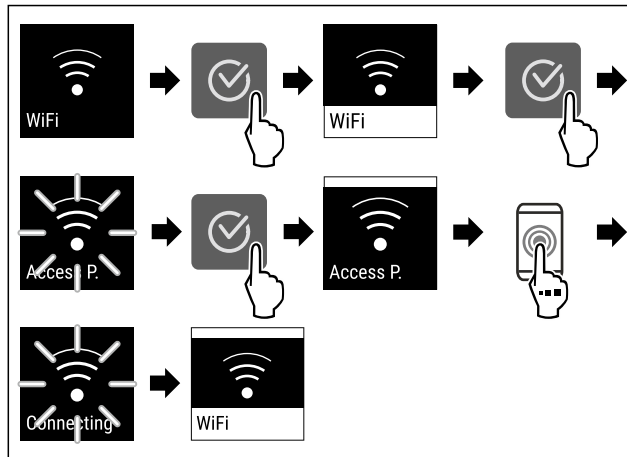

Fig. 11

- ▶ Carry out action steps according to the illustration.
- ▶ Connection is established.

#### Disconnecting from the WiFi



Fig. 12

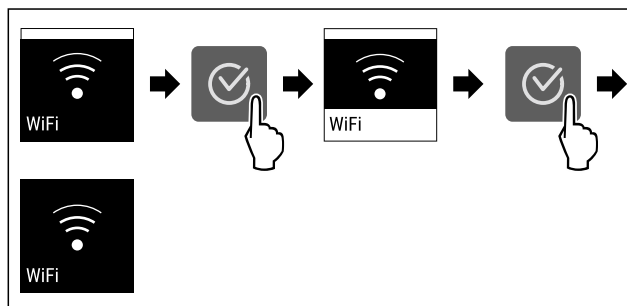

Fig. 13

- ▶ Carry out action steps according to the illustration.
- ▶ There is no connection.

#### Resetting the WiFi connection

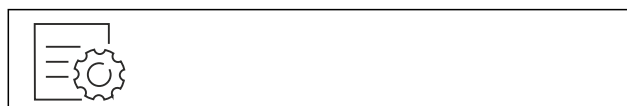

Fig. 14

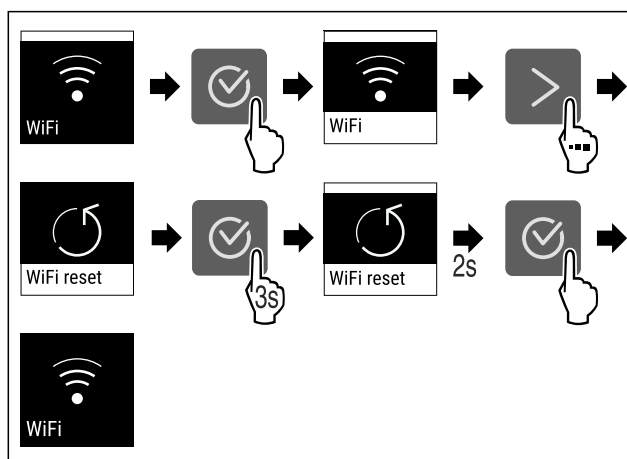

Fig. 15

- ▶ Carry out action steps according to the illustration.
- ▶ WiFi connection and other WiFi settings are reset to factory settings.

# Controls

## Showing information about the WiFi connection



Fig. 16

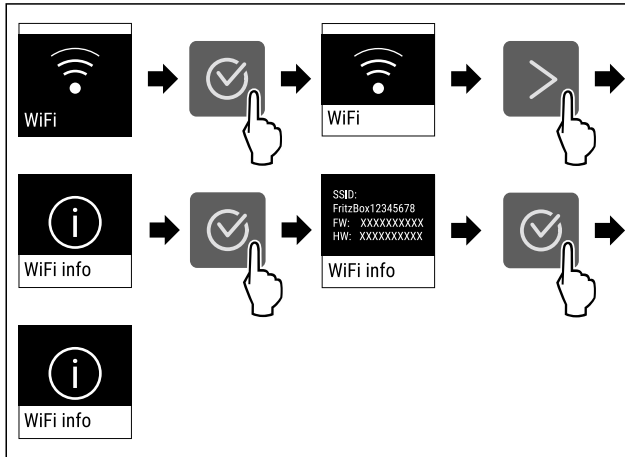

Fig. 17

► Carry out action steps according to the illustration.

## -18°C Temperature

Use this function to set the temperature.

The temperature depends on the following factors:

- Frequency of door opening
- Duration of door opening
- Room temperature of the installation site
- Type, temperature and quantity of food

Freezer compartment	Factory-set temperature	Recommended setting
-18°C	-18 °C	-18 °C

## Setting the temperature

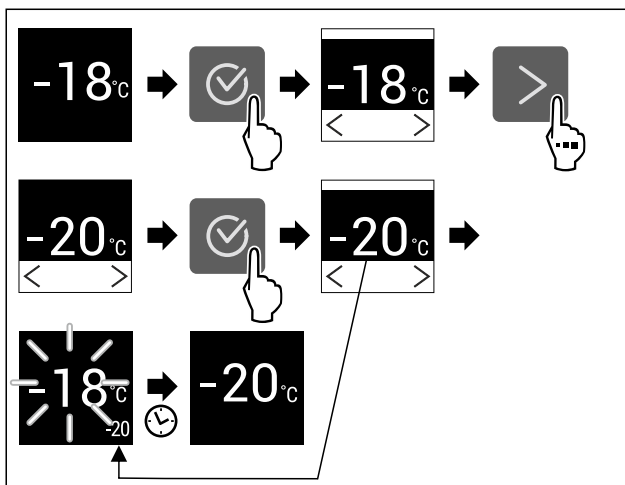

Fig. 18 Example illustration

► Carry out action steps according to the illustration.  
 ► Temperature is set.

## °C/°F Temperature unit

Use this function to set the temperature unit. You can set degrees Celsius or degrees Fahrenheit as the temperature unit.

## Setting the temperature unit



Fig. 19

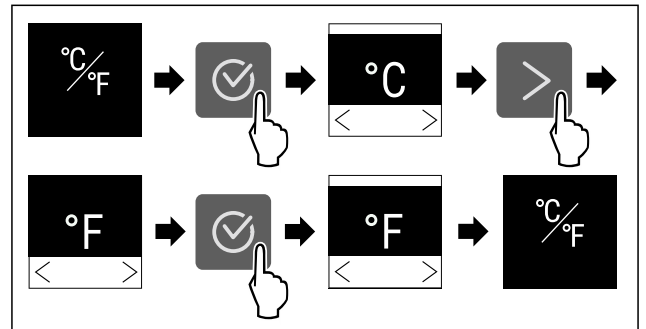

Fig. 20 Example illustration: Switch from degrees Celsius to degrees Fahrenheit.

► Carry out action steps according to the illustration.  
 ► The temperature unit is set.

## \*\* SuperFrost

You can use this function to activate or deactivate SuperFrost. If SuperFrost is activated, then the appliance increases the freezing capacity. It allows you to achieve lower freezing temperatures.

Application:

- Quickly freeze fresh food through to the core. This ensures that the nutrition, appearance and taste of frozen food is maintained.
- Increase the cold reserve in stored frozen food before defrosting the appliance.

If the function is active, the appliance operates at higher power. As a result, the appliance's operating noise may be temporarily louder and energy consumption will increase.

If the door is open for too long, e.g. because you are putting food in, the appliance automatically checks whether the actual temperature in the appliance matches the set temperature. If the difference exceeds a certain value, the appliance automatically cools more vigorously. As a result, the temperature shown on the display may be higher than the actual temperature in the appliance. This is normal and your appliance is working correctly.\*

## Activating SuperFrost

Make sure that the following requirements are fulfilled:

- Freezing quantity and time for activation of SuperFrost are taken into account. (see Freezing food using SuperFrost)



Fig. 21

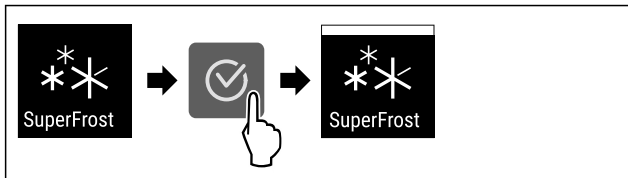

Fig. 22

- ▶ Carry out action steps according to the illustration.
- ▶ SuperFrost is activated.

### Deactivating SuperFrost

SuperFrost is automatically deactivated after 56 to 72 hours depending on the quantity of the food inserted. However, you can also deactivate SuperFrost manually at any time:



Fig. 23

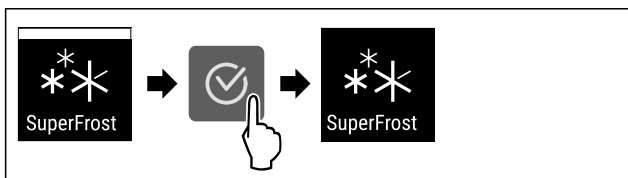

Fig. 24

- ▶ Carry out action steps according to the illustration.
- ▶ SuperFrost is deactivated.
- ▶ The appliance continues to run in normal mode.
- ▶ The appliance cools to the temperature set previously.

## Start defrosting cycle

Use this function to start the automatic defrosting cycle manually if it does not start automatically in the event of a fault.

### Starting defrosting cycle



Fig. 25

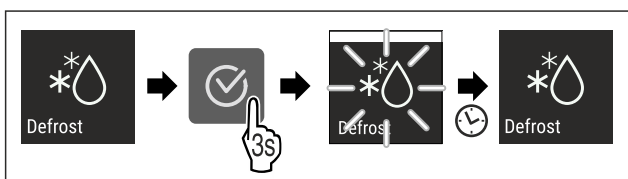

Fig. 26

- ▶ Carry out action steps according to the illustration.
- ▶ Defrosting cycle has started: Icon flashes until defrosting cycle is automatically completed.
- ▶ When defrosting cycle is finished: The device continues to run in normal mode.

### Cancelling defrosting cycle

The defrosting cycle will be stopped automatically. However, you can also cancel the defrosting cycle at any time during the defrosting process:

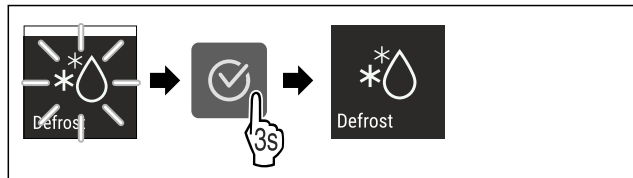

Fig. 27

- ▶ Carry out action steps according to the illustration.
- ▶ Defrosting cycle is cancelled.
- ▶ The device continues to run in normal mode.

## PartyMode

You can use this function to activate or deactivate Party-Mode. PartyMode activates various functions that are useful for a party.

PartyMode activates the following functions:

- SuperFrost (see SuperFrost)

You can adjust all listed functions individually and flexibly. When you deactivate PartyMode, all changes are discarded.

If the function is active, the device operates at higher power. As a result, the device's operating noise may be temporarily louder and energy consumption will increase.

### Activating PartyMode

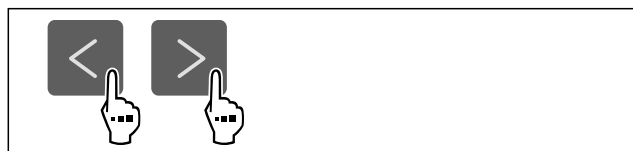

Fig. 28

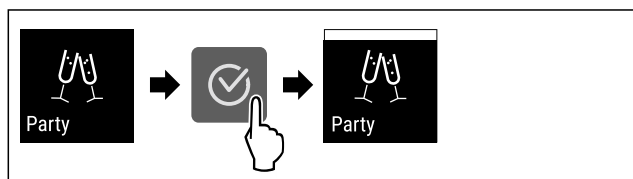

Fig. 29

- ▶ Carry out action steps according to the illustration.
- ▶ PartyMode and the associated functions are activated.
- ▶ The current temperature flashes until the target temperature is reached.

### Deactivating PartyMode

The PartyMode is automatically deactivated after 24 seconds. However, you can also deactivate PartyMode manually at any time:



Fig. 30

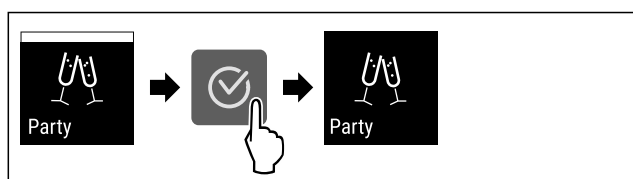

Fig. 31

- ▶ Carry out action steps according to the illustration.
- ▶ PartyMode is deactivated.

# Controls

- ▷ The appliance cools to the temperature set previously: The current temperature flashes until the target temperature is reached.



## SabbathMode

You can use this function to activate or deactivate SabbathMode. If you activate this function, some electronic functions are switched off. As a result, your device meets the religious requirements for Jewish holidays such as Sabbath and complies with STAR-K Kosher certification.

Device status when SabbathMode is active
The status display shows SabbathMode permanently.
All functions on the display are locked except for the <b>Deactivate SabbathMode function</b> .
Active functions remain active.
The display remains bright when you close the door.
Reminders are not implemented. The set time interval stops.
Reminders and warnings are not displayed.
There is no door alarm.
There is no temperature alarm.
The defrosting cycle operates only for the specified time, without considering the appliance consumption.
After a power failure, the appliance returns to SabbathMode.

*Device status*

### Note

This appliance has certification from the "Institute for Science and Halacha". ([www.machonhalacha.co.il](http://www.machonhalacha.co.il))

You can find a list of STAR-K-certified appliances at [www.star-k.org/appliances](http://www.star-k.org/appliances).

### Activating SabbathMode



### WARNING

Danger of food poisoning from spoiled food!  
If you have SabbathMode activated and a power failure occurs, no message appears in the status display about the power failure. Once the power is restored, the appliance continues to operate in SabbathMode. The power failure may mean that food spoils and the consumption of this food could lead to food poisoning.

After a power failure:

- ▶ Do not consume food that was frozen and has thawed out.



Fig. 32

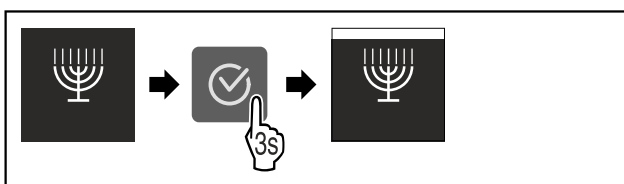

Fig. 33

- ▶ Carry out action steps according to the illustration.

- ▷ SabbathMode is activated.
- ▷ The status display shows SabbathMode permanently.

### Deactivating SabbathMode

The SabbathMode is automatically deactivated after 80 hours. However, you can also deactivate SabbathMode manually at any time:

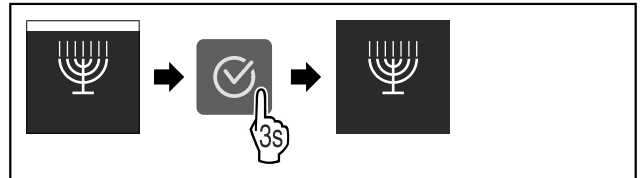

Fig. 34

- ▶ Carry out action steps according to the illustration.
- ▷ SabbathMode is deactivated.



## E-Saver

You can use this function to activate or deactivate Energy saving mode. If energy saving mode is activated, the energy consumption decreases and the temperature in the device increases. The food remains fresh, but the shelf life is shortened.

Temperature zone	Recommended setting (see Setting the temperature)	Temperature with active E-Saver
-18 °C	-18 °C	-16 °C

*Temperatures*

### Activating E-Saver



Fig. 35

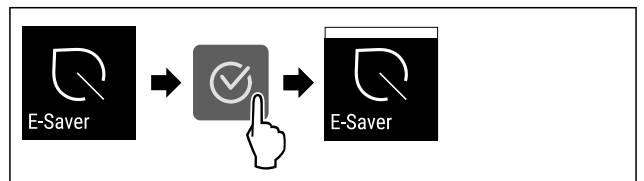

Fig. 36

- ▶ Carry out action steps according to the illustration.
- ▷ Energy saving mode is activated.

### Deactivating E-Saver



Fig. 37

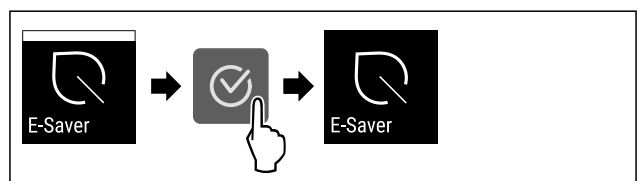

Fig. 38

- ▶ Carry out action steps according to the illustration.
- ▷ Energy saving mode is deactivated.

## Display brightness

Use this function to set the display brightness in stages.

You can select the following brightness levels:

- 40 %
- 60 %
- 80 %
- 100 % (pre-setting)

### Setting the brightness



Fig. 39

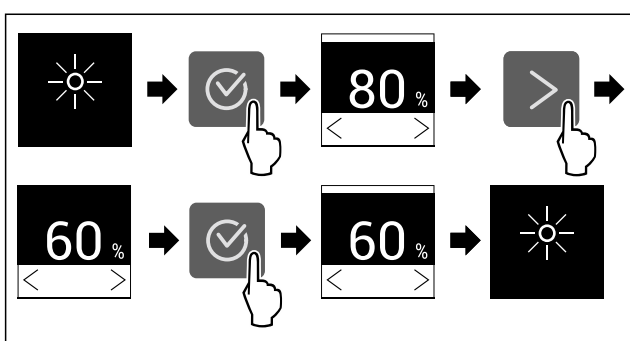

Fig. 40 Example illustration: Switch from 80 % to 60 %.

- ▶ Carry out action steps according to the illustration.
- ▷ The brightness is set.

## Door alarm

Use this function to activate or deactivate the door alarm. The door alarm sounds if the door is open for too long. The door alarm is activated on delivery. You can set how long the door may be open before the door alarm sounds.

The following values can be set:

- 1 minute
- 2 minutes
- 3 minutes
- Off

### Setting the door alarm



Fig. 41

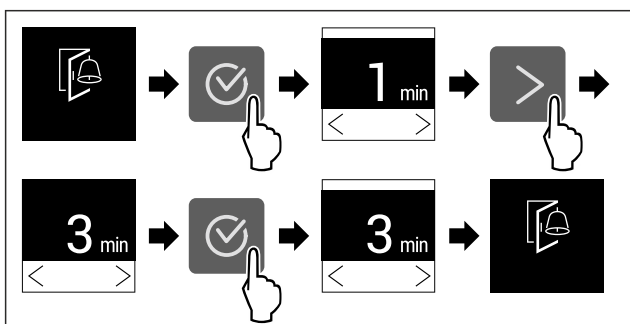

Fig. 42 Example illustration: Change door alarm from 1 minute to 3 minutes.

- ▶ Carry out action steps according to the illustration.
- ▷ The door alarm is set.

### Deactivating the door alarm



Fig. 44

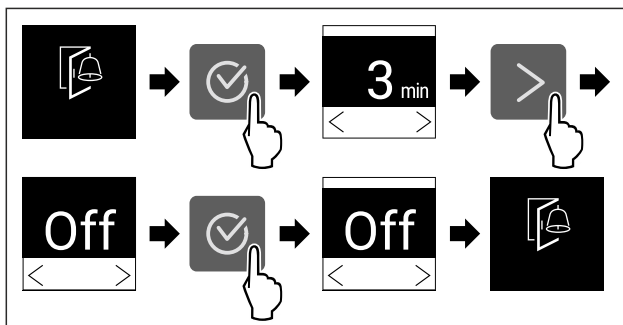

Fig. 45

- ▶ Carry out action steps according to the illustration.
- ▷ The door alarm is deactivated.

## Input lock

You can use this function to activate or deactivate the input lock. The input lock prevents the appliance being operated accidentally, e.g. by children.

Application:

- Avoid unintentional modification of functions.
- Avoid unintentional switching off of the device.
- Avoid unintentional temperature setting.

### Activating the input lock

If you activate the input lock, you can continue to navigate in the menus but you cannot select or change other functions.



Fig. 46

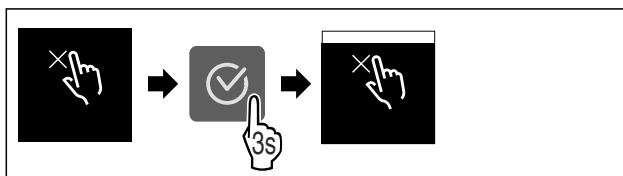

Fig. 47

- ▶ Carry out action steps according to the illustration.
- ▷ Input lock is activated.

### Deactivating the input lock



Fig. 48



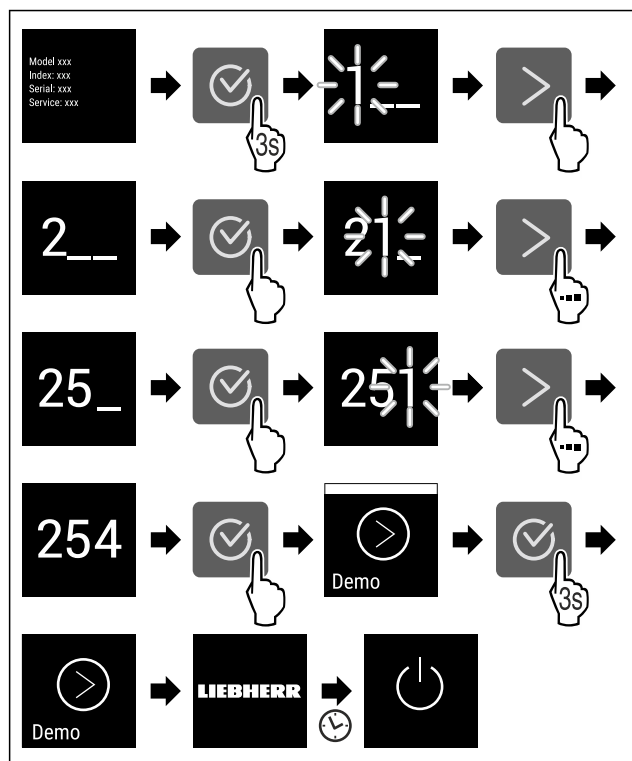

Fig. 57

- ▶ Carry out action steps according to the illustration.
- ▶ Demo mode is deactivated.
- ▶ Appliance is switched off.
- ▶ Switch on the appliance. (see 4.1 Switching on appliance (first use))
- ▶ Appliance is reset to factory settings.

## Resetting to factory settings

Use this function to reset all settings to factory defaults. All settings you have made so far are reset to their original settings.

### Performing a reset



Fig. 58

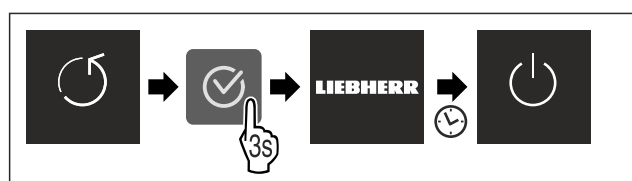

Fig. 59

- ▶ Carry out action steps according to the illustration.
- ▶ Device is reset.
- ▶ Device is switched off.
- ▶ Restart the device. (see 4.1 Switching on appliance (first use))

## 7.3 Messages



There are two categories of messages:

Category	Importance
Warning	Warnings appear in the event of a door alarm or malfunction. Simple warnings can be cancelled by yourself. In the event of serious malfunctions, you must contact customer service. (see 10.4 Customer Service)
Reminder	Reminders remind you of general processes. You can carry out these operations to end the message.

### 7.3.1 Overview of warnings

Behaviour of the appliance in the event of warnings:

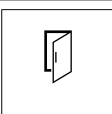
- Warning appears on the display.
- The alarm tone sounds at an ever-increasing volume.

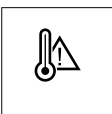
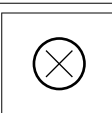
Message	Cause	Exit the message
 <b>Door alarm</b>	The message appears if the door is open for too long.	Carry out action steps. (see Door alarm)
 <b>Power outage alarm</b>	The message appears if the freezing temperature has risen due to a power failure.	Carry out action steps. (see Power outage alarm)
 <b>Temperature alarm</b>	The message appears if the freezing temperature does not correspond to the set temperature.	Carry out action steps. (see Temperature alarm)
 <b>Error</b>	The message appears if there is an appliance error. A component of the appliance has a fault.	Carry out action steps. (see Error)

### 7.3.2 Ending warnings

#### Door alarm

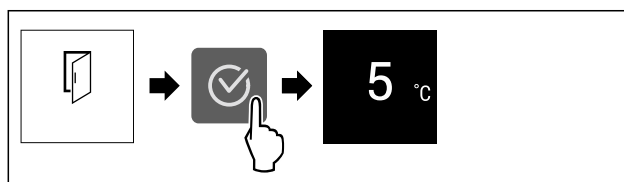

Fig. 60 Example illustration

- ▶ Carry out action steps according to the illustration.

-or-

- ▶ Close the door.
- ▶ The display returns to the status indicator.
- ▶ The appliance cools more vigorously, which means that the temperature shown on the display may be higher than the actual temperature inside the appliance.\*
- ▶ Appliance noises can be louder.\*

You can set how long the door may be open before the door alarm sounds. (see Setting the door alarm)

# Features

## Power outage alarm

When the power failure has ended, the appliance will automatically cool down to the previously set target temperature without you having to confirm the message. However, for the message to disappear from the display, you must confirm it.

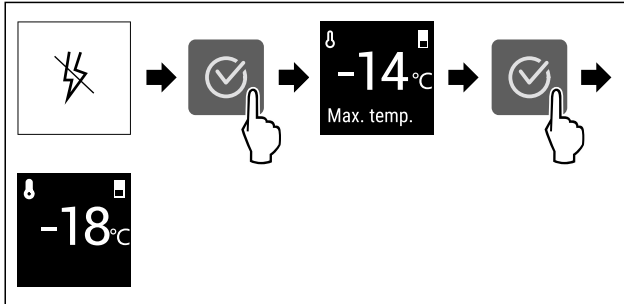

Fig. 61 Example illustration

- ▶ Press the confirmation symbol.
- ▶ Warmest freezing temperature is displayed.
- ▶ If the freezing temperature was below -9 °C: Food can still be consumed.  
If the freezing temperature has risen above -9 °C:
- ▶ Check the food.
- ▶ Press the confirmation symbol.
- ▶ The display returns to the status indicator: Current temperature and target temperature are displayed.

## Temperature alarm

Temperature differences can be caused by:

- You have put in warm, fresh food.
- Too much warm air has got in while you were sorting out the freezer or removing items.
- There has been a longer power failure.
- The appliance is faulty.
- ▶ Eliminate causes.
- ▶ The appliance cools to the target temperature set previously.

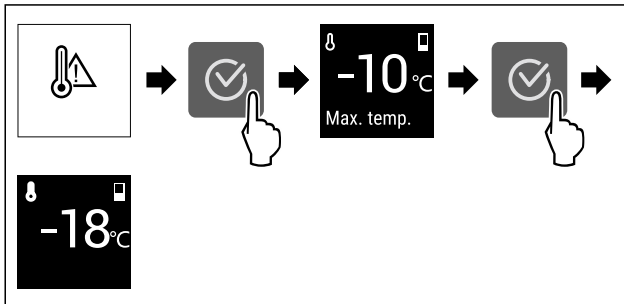

Fig. 62 Example illustration

- ▶ Press the confirmation symbol.
- ▶ Warmest freezing temperature is displayed.
- ▶ If the freezing temperature was below -9 °C: Food can still be consumed.  
If the freezing temperature has risen above -9 °C:
- ▶ Check the food.
- ▶ Press the confirmation symbol.
- ▶ The display returns to the status indicator: Current temperature and target temperature are displayed.

## Error

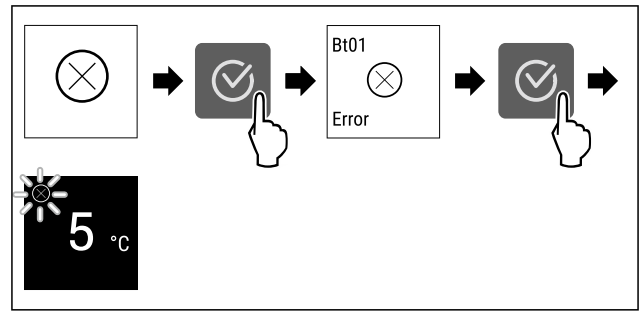

Fig. 63 Example illustration

- ▶ Press the confirmation symbol.
- ▶ Error code is displayed.
- ▶ Note the error code.
- ▶ Press the confirmation symbol.
- ▶ The display returns to the status indicator.
- ▶ Contact Customer Service. (see 10.4 Customer Service)

## 7.3.3 Overview of reminders

Behaviour of the appliance during reminders:

- Reminder appears on the display.
- Alarm tone sounds.

# 8 Features

## 8.1 Drawers

You can remove the drawers for cleaning.

You can remove the drawers to use VarioSpace.

The way to remove/insert the drawers varies depending on the pull-out system. Your appliance can contain various pull-out systems.

### Note

The energy consumption increases and the cooling power goes down if ventilation is not sufficient.

- ▶ Leave the bottom drawer inside the appliance.
- ▶ Always keep the inside vents at the rear wall clear.

### 8.1.1 Top tilting drawer

When you pull out the top drawer, it tilts forward. This gives you a better view into the drawer. The function depends on the height of the appliance.

#### Removing drawer

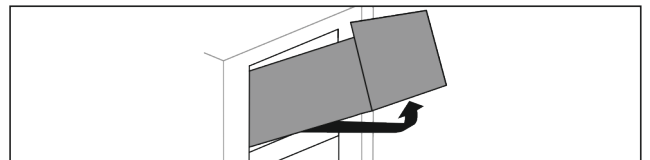

Fig. 64

- ▶ Pull out drawer as far as it will go.
- ▶ Lift drawer at the front.
- ▶ Lift drawer from below.
- ▶ Remove drawer to the front.

## Inserting drawer

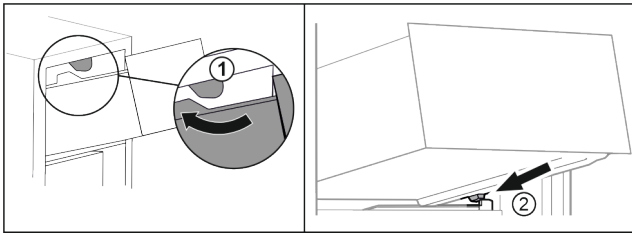

Fig. 65

- ▶ Guide drawer around the upper stoppers. Fig. 65 (1)
- ▶ Place drawer at an angle behind the lower stoppers onto moulded rib. Fig. 65 (2)
- ▶ Lower drawer.
- ▶ Slide to the back.

### 8.1.2 Drawer on moulded rib

The drawer runs directly on the moulded rib. There are no rails.

#### Removing drawer

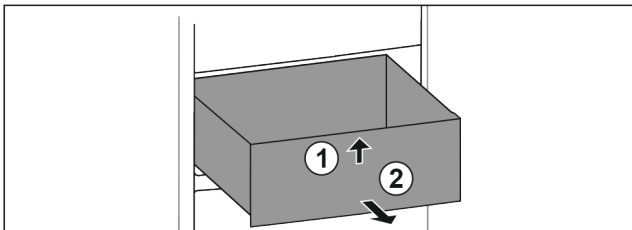

Fig. 66

- ▶ Pull out drawer as far as it will go.
- ▶ Lift up drawer at the front. Fig. 66 (1)
- ▶ Remove drawer to the front. Fig. 66 (2)

#### Inserting drawer

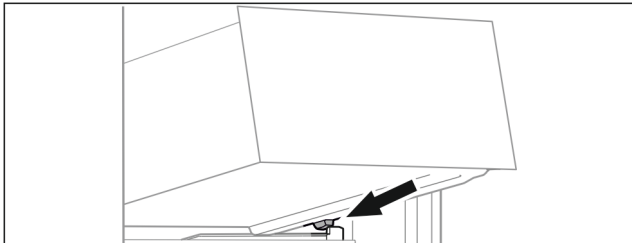

Fig. 67

- ▶ Place drawer at an angle behind the stoppers on the moulded rib. (see Fig. 67)
- ▶ Lower drawer.
- ▶ Slide in drawer to the back.

### 8.1.3 Bottom drawer

The drawer is the lowest drawer in the appliance. It runs directly on the moulded rib. There are no rails.

#### Removing drawer

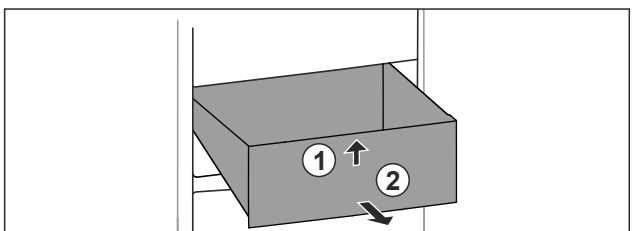

Fig. 68

- ▶ Pull out drawer as far as it will go.
- ▶ Lift up drawer at the front. Fig. 68 (1).
- ▶ Remove drawer to the front. Fig. 68 (2).

## Inserting drawer

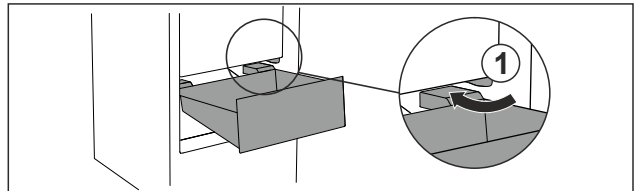

Fig. 69

- ▶ Guide drawer in at an angle around the stoppers Fig. 69 (1).
- ▶ Lower drawer.
- ▶ Slide in drawer to the back.

## 8.2 EasyTwist-Ice

With the EasyTwist-Ice you can make enough ice cubes for the whole household. The EasyTwist-Ice is supplied with water via a water tank.

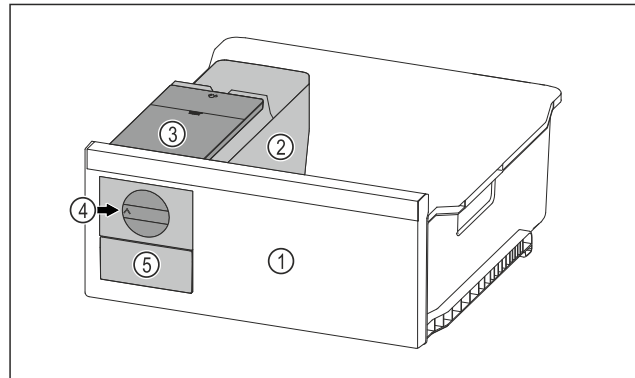

Fig. 70 Example illustration

- (1) Freezer drawer with EasyTwist-Ice
- (2) Body with ice cube tray
- (3) Water tank
- (4) Rotary knob
- (5) Ice cube drawer

#### Note

Do not change the position of the freezer drawer with the EasyTwist-Ice in the appliance.

### 8.2.1 Making ice cubes

The amount of ice cubes you can make in a given period of time with the EasyTwist-Ice depends on the freezer temperature of the appliance. The lower the temperature in the appliance, the more ice cubes you can make.

Maximum number of ice cubes in the ice cube tray:	20 ice cubes
Maximum capacity of the ice cube drawer:	40 ice cubes (equivalent to two ice cube batches)
More information about the time needed for ice cube production:	(see 10.1 Technical specifications)

Make sure that the following requirements are fulfilled:

- Components of the EasyTwist-Ice have been cleaned.

#### Filling the water tank



#### WARNING

Risk of poisoning due to contaminated water!

- ▶ Only fill the water tank with potable water.

# Maintenance

## NOTICE

Sugar-content liquids!  
Damage to EasyTwist-Ice.

- ▶ Only fill with cold drinking water.

## Note

Using filtered, decarbonised water ensures the best-tasting drinking water for your ice cubes. This water quality can be achieved using a table water filter of the kind available in trade retail outlets.

- ▶ Always fill the water tank only with filtered, decarbonised drinking water.

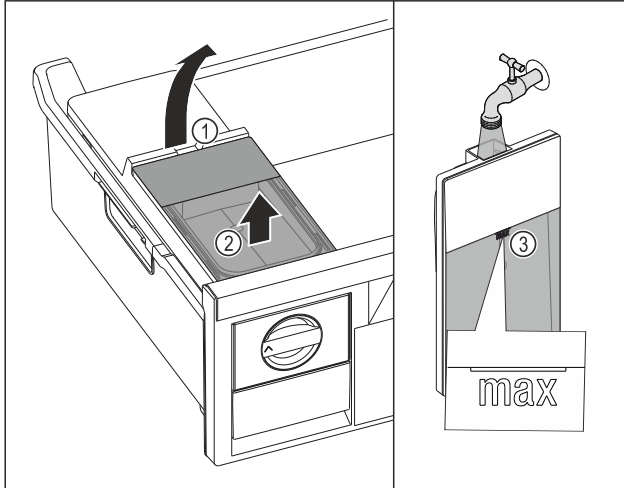

Fig. 71

- ▶ Pull out freezer drawer as far as it will go.
- ▶ Lift the water tank at the recess Fig. 71 (1).
- ▶ Remove the water tank by lifting it upwards. Fig. 71 (2)
- ▶ Fill the water tank with drinking water up to the mark Fig. 71 (3).

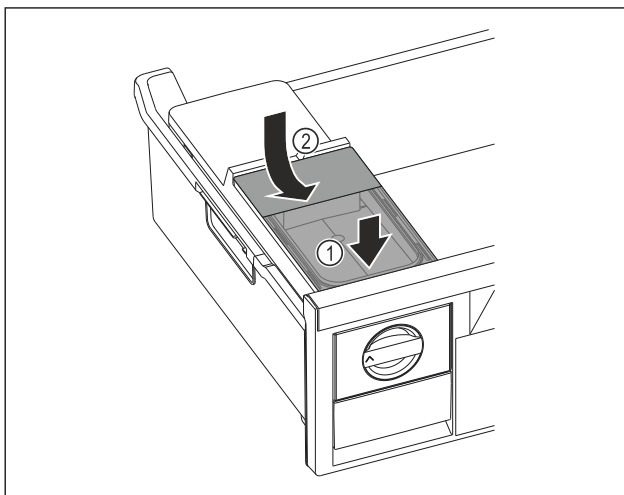

Fig. 72

- ▶ Position the water tank at the front. Fig. 72 (1)
- ▶ Lower the water tank at the rear. Fig. 72 (2)
- ▶ Slide in the freezer drawer.

## Releasing the ice cubes

Make sure that the following requirements are fulfilled:

- The required time for the production of ice cubes has been observed. (see 10.1 Technical specifications)
- Freezer drawer is fully inserted.
- Ice cube drawer is fully inserted.
- ▶ Turn the rotary knob Fig. 70 (4) clockwise as far as it will go.

- ▶ Ice cubes fall from the ice cube tray into the ice cube drawer Fig. 70 (5).
- If all the ice cubes do not come out of the ice cube tray:
- ▶ Turn the rotary knob clockwise several times to the stop.

## 8.3 VarioSpace

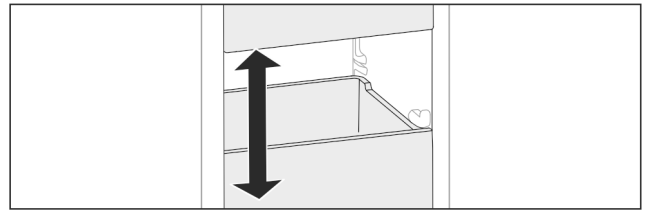

Fig. 73

You can remove drawers and glass panels from your appliance. This provides more room for large food items such as poultry, joints of meat, large game, and tall baked products. You can then freeze these items whole for later preparation.

- ▶ Note the weight limits on the drawers and glass panels (see 10.1 Technical specifications).

## 9 Maintenance

### 9.1 Disassembling / assembling pull-out systems

#### 9.1.1 Notes on disassembly

You can disassemble some of the pull-out systems for cleaning. Your appliance can contain a variety of pull-out systems.

The following pull-out systems can be disassembled or cannot be disassembled:

Pull-out system	can be disassembled / cannot be disassembled
Top tiltable drawer	cannot be disassembled
Drawer guided on container rib	can be disassembled (see 9.1.2 Drawer on moulded rib)
Bottom drawer	cannot be disassembled

#### 9.1.2 Drawer on moulded rib

##### Disassembling pull-out system

Make sure the following prerequisites are met:

- Drawer has been removed. (see 8.1.2 Drawer on moulded rib)

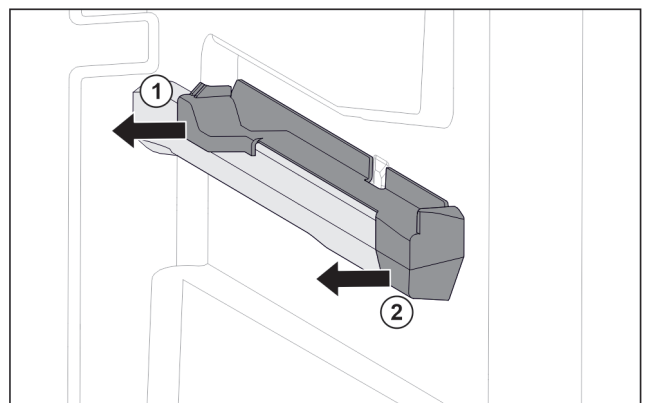

Fig. 74 Attachment on the right moulded rib

- ▶ Grab attachment at the back from below.

- ▶ Pull off attachment at the back sideways. Fig. 74 (1)
- ▶ Pull off attachment at the front sideways. Fig. 74 (2)

## Installing pull-out system

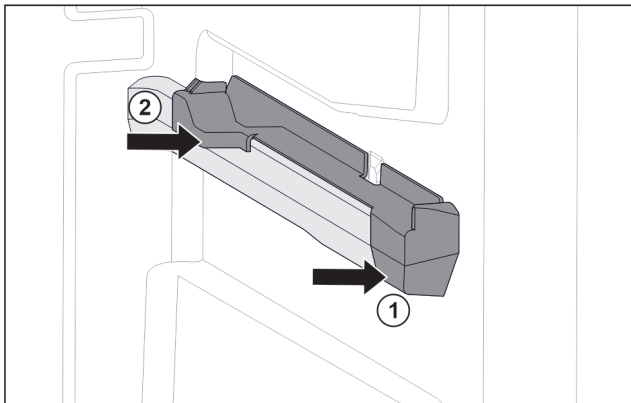

Fig. 75 Attachment on the right moulded rib

- ▶ Position attachment on moulded rib at the front. Fig. 75 (1)
- ▶ Press on attachment at the back. Fig. 75 (2)

## 9.2 Defrosting the appliance

### 9.2.1 Defrosting with NoFrost

Defrosting is performed automatically with the NoFrost system. The moisture is deposited on the evaporator, is periodically defrosted and evaporates.

The appliance does not have to be defrosted.

#### Note

Water droplets may collect on the bottom of the appliance. When you take the appliance out of operation:

- ▶ Place a towel in front of the appliance to catch any water droplets that escape. (see 11 Shutting down)

## 9.3 Cleaning the appliance

### 9.3.1 Ready



#### WARNING

Danger of electric shock!

- ▶ Remove the refrigerator connector or interrupt the power supply.



#### WARNING

Risk of fire

- ▶ Do not damage the refrigeration circuit.

- ▶ Empty the appliance.
- ▶ Remove mains connector.

### 9.3.2 Clean the housing

#### NOTICE

Improper cleaning!  
Damage to the appliance.

- ▶ Only use soft cleaning cloths and ph-neutral all-purpose cleaners.
- ▶ Do not use abrasive sponges or steel wool which may cause scratches.
- ▶ Do not use any sharp or abrasive cleaning agents, nor any that contain sand, chloride or acid.



#### WARNING

Risk of injury and damage as a result of hot steam!  
Hot steam can lead to burns and can damage the surfaces.

- ▶ Do not use any steam cleaners!
- ▶ Wipe the housing down with soft, clean cloth. If very dirty, use lukewarm water with a neutral cleaner. Glass surfaces can also be cleaned with glass cleaner.

### 9.3.3 Cleaning the interior

#### NOTICE

Improper cleaning!  
Damage to the appliance.

- ▶ Only use soft cleaning cloths and ph-neutral all-purpose cleaners.
- ▶ Do not use abrasive sponges or steel wool which may cause scratches.
- ▶ Do not use any sharp or abrasive cleaning agents, nor any that contain sand, chloride or acid.

- ▶ Plastic surfaces: clean by hand with a soft clean cloth, lukewarm water and a little detergent.
- ▶ Metal surfaces: clean by hand with a soft clean cloth, lukewarm water and a little detergent.

### 9.3.4 Clean the components

#### NOTICE

Improper cleaning!  
Damage to the appliance.

- ▶ Only use soft cleaning cloths and ph-neutral all-purpose cleaners.
- ▶ Do not use abrasive sponges or steel wool which may cause scratches.
- ▶ Do not use any sharp or abrasive cleaning agents, nor any that contain sand, chloride or acid.

Clean with a soft, clean cloth, lukewarm water and some detergent:

- Drawer
- Freezer tray
- Components of the EasyTwist-Ice
- ▶ To disassemble components: see the relevant section.
- ▶ Clean the components.

### 9.3.5 Cleaning the EasyTwist-Ice

Clean the EasyTwist-Ice in the following situations:

- First use
- Not using for more than 48 hours
- When cleaning is required

#### Dismantling the EasyTwist-Ice

Make sure that the following requirements are fulfilled:

- The drawer has been removed. (see 8.1 Drawers)
- The drawer is placed on a table.

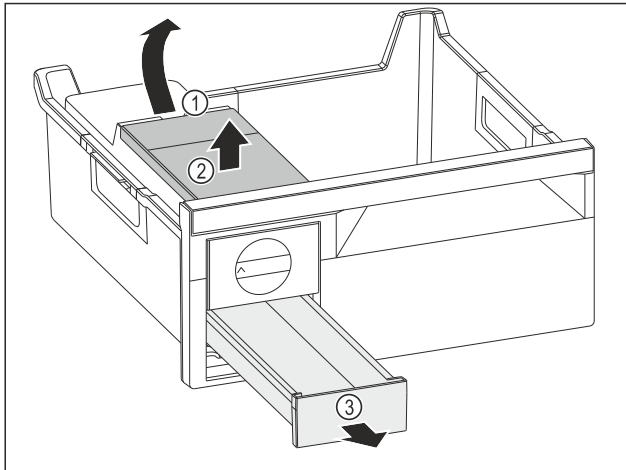

Fig. 76

- ▶ Removing the water tank: Lift the water tank by the recess Fig. 76 (1).
- ▶ Remove the water tank Fig. 76 (2) upwards.
- ▶ Remove the ice cube drawer Fig. 76 (3) to the front.

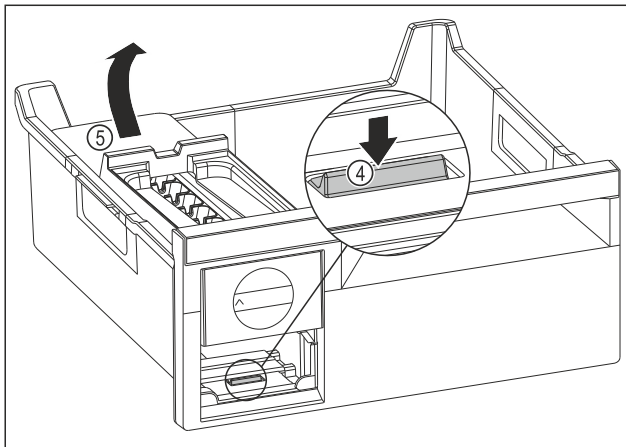

Fig. 77

- ▶ Removing the EasyTwist-Ice body: Use your finger to push the tab Fig. 77 (4) down and use your other hand to lift the EasyTwist-Ice body Fig. 77 (5) from behind at the same time.
- ▶ Remove the EasyTwist-Ice body from the freezer drawer.

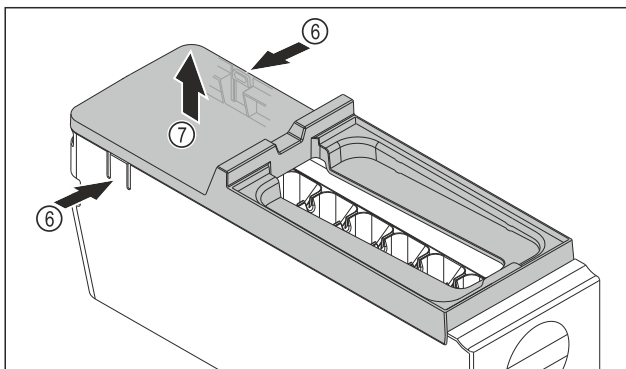

Fig. 78

- ▶ Removing the EasyTwist-Ice body cover: Push the tabs Fig. 78 (6) on both sides of the EasyTwist-Ice body with one hand.
- ▶ Use the other hand to remove the cover Fig. 78 (7) upwards.
- ▶ EasyTwist-Ice is dismantled into four parts. (see Fig. 79)

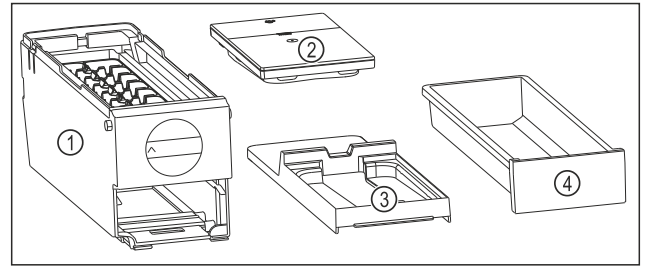

Fig. 79 Components of the EasyTwist-Ice

- (1) EasyTwist-Ice body with ice cube tray
- (2) Water tank
- (3) Cover
- (4) Ice cube drawer

## NOTICE

Risk of damage due to improper dismantling! Equipment breaking, jumping and cracking. If you dismantle the EasyTwist-Ice body further, you may damage the rotary knob or other parts of the EasyTwist-Ice body.

- ▶ Only dismantle the EasyTwist-Ice into the components shown. (see Fig. 79)
- ▶ Clean the EasyTwist-Ice body Fig. 79 (1) as a whole.

## Cleaning the EasyTwist-Ice

Make sure that the following requirements are fulfilled:

- ❑ The EasyTwist-Ice is dismantled. (see Dismantling the EasyTwist-Ice)
- ▶ Clean the ice cube drawer, water tank, cover and EasyTwist-Ice body with warm water and a little detergent.
- ▶ Dry all cleaned components thoroughly with a dry cloth.
- ▶ The EasyTwist-Ice is clean.

## Installing the EasyTwist-Ice

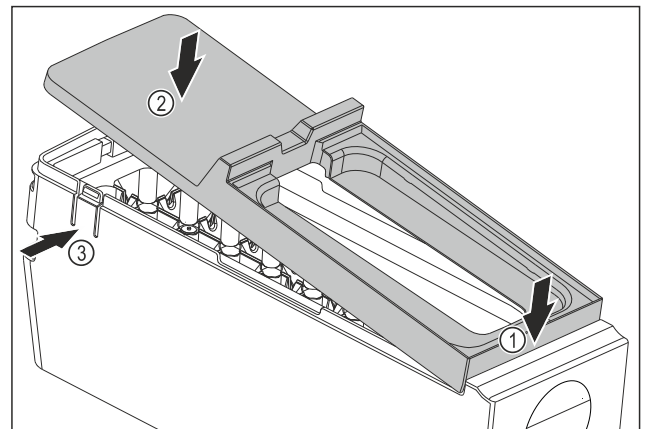

Fig. 80

- ▶ Installing the EasyTwist-Ice body cover: Place the cover on the front. Fig. 80 (1)
- ▶ Lower the cover at the rear. Fig. 80 (2)
- ▶ The cover locks into both tabs Fig. 80 (3) audibly.

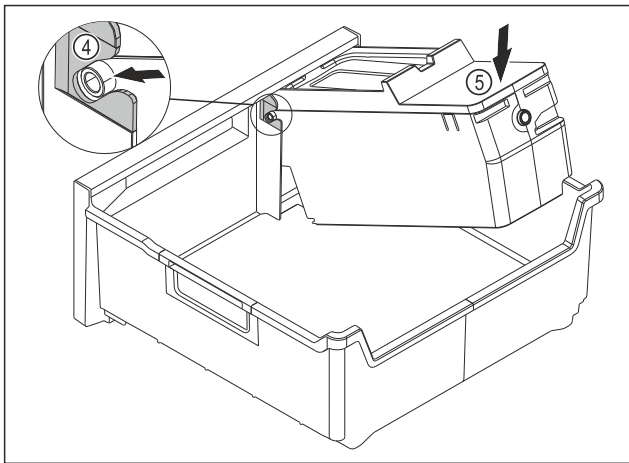

Fig. 81

- ▶ Installing the EasyTwist-Ice body: Push the axes for the EasyTwist-Ice body into the guides Fig. 81 (4).
- ▶ Press the EasyTwist-Ice body Fig. 81 (5) down at the back.
- ▶ The EasyTwist-Ice body locks in audibly.

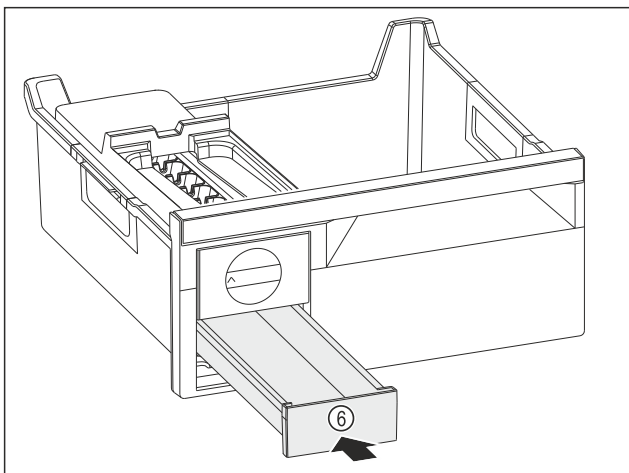

Fig. 82

- ▶ Insert the ice cube drawer Fig. 82 (6).



**WARNING**

Risk of poisoning due to contaminated water!

- ▶ Only fill the water tank with potable water.
- 
- ▶ Fill the water tank with water.
  - ▶ Insert the water tank.
  - ▶ Insert the drawer. (see 8.1 Drawers)
  - If you are using unfiltered water:
  - ▶ Dispose of ice cubes that were produced 24 hours after initial ice cube production.
  - or-
  - If you are using filtered water:
  - ▶ Dispose of ice cubes that were produced 48 hours after initial ice cube production.

**9.3.6 After cleaning**

- ▶ Wipe the appliance and the components dry.
- ▶ Connect and switch on the appliance.
- ▶ Activate SuperFrost (see 7.2 Appliance functions) . The temperature is cold enough:
- ▶ Place the food inside.
- ▶ Repeat cleaning regularly.

**10 Customer help**

**10.1 Technical specifications**

Temperature range	
Freeze	-28 °C to -15 °C

Maximum ice cube quantity / 24 hours	
Freezer compartment	see type plate under "Freezing capacity .../ 24 h"

Maximum loading weight for the equipment			
Equipment	Appliance width 600 mm (see installation instructions, device dimensions)	Appliance width 700 mm (see installation instructions, device dimensions)	Appliance width 750 mm (see installation instructions, device dimensions)
Drawer on container rib (see 8.1.2 Drawer on moulded rib)	19 kg	25 kg	--
Bottom drawer (see 8.1.3 Bottom drawer)	11 kg	19 kg	
Top tiltable drawer (see 8.1.1 Top tilting drawer)	19 kg	19 kg	--

Ice cube production with EasyTwist-Ice	
Time required at -18 °C	approx. 5.5 hours
Time required with SuperFrost activated	approx. 3 hours

**10.2 Operating noises**

The appliance makes different noises when it is on.

- At **higher temperatures** the appliance uses less energy but works for longer. It is **quieter**.
- At **lower temperatures** the food is cooled faster. It is **louder**.

Examples:

- Functions on (see 7.2 Appliance functions)
- Fan running
- Food recently added
- High ambient temperature
- Door open for a while

Noise	Possible cause	Type of noise
Bubbling and splashing	Coolant flowing into the cooling circuit.	Normal operating noise
Hissing	Coolant sprays into the cooling circuit.	Normal operating noise

# Customer help

Noise	Possible cause	Type of noise
Humming	The appliance is cooling. The volume depends on the cooling output.	Normal operating noise
Humming and rustling	The fan is running.	Normal operating noise
Clicking	Components are switched on and off.	Normal switching noise
Rattling or humming	Valves or flaps are working.	Normal switching noise
Faint knocking, humming or buzzing*	The valve is active.	Normal operating noise

Noise	Possible cause	Type of noise	Lifting
Vibration	Improper setup	Defective noise	Level the appliance using the adjustable feet.

Noise	Possible cause	Type of noise	Lifting
Rattling	Components, items inside the appliance	Defective noise	Secure components. Leave enough space between the items.

## 10.3 Technical fault

Your appliance is designed and built to ensure it works reliably and has a long service life. In the unlikely event that a fault occurs during operation, please check whether it is due to an operating error. If so, you will be charged for the callout and repair costs even if it falls within the warranty period.

You can fix the following faults yourself.

### 10.3.1 Appliance function

Defect	Cause	Remedy
<b>The appliance is not working.</b>	→ The appliance is not switched on.	▶ Switch the appliance on.
	→ The power plug is not properly plugged into the socket.	▶ Check the power plug.
	→ There is something wrong with the power outlet fuse.	▶ Check the fuse.
	→ Power cut	▶ Keep the appliance closed. ▶ Safeguarding food: Place cold packs on top of food or use another freezer if the power cut lasts longer. ▶ Do not re-freeze defrosted food,
	→ The IEC socket is not plugged into the appliance correctly.	▶ Check the IEC socket.
<b>Temperature is not cold enough.</b>	→ The appliance door is not closed properly.	▶ Close the appliance door.
	→ The ambient temperature is too high.	▶ Problem solution: (see 2.4 Appliance range of use)
	→ The appliance was opened too many times or for too long.	▶ Wait to see if the required temperature corrects itself. If not, contact Customer Service. (see 10.4 Customer Service)
	→ Too much fresh food was placed inside without SuperFrost.	▶ Solution: (see SuperFrost)
	→ The temperature is set incorrectly.	▶ Turn down the temperature and check after 24 hours.
	→ The appliance is too close to a heat source (oven, radiator, etc).	▶ Move the appliance or the heat source.
<b>The temperature shown on the display is higher than the actual temperature in the appliance.*</b>	→ Appliance door was open for a long time and the door alarm was triggered automatically. This causes the appliance to cool more vigorously.	▶ Close appliance door.

Defect	Cause	Remedy
The door seal is defective or needs to be replaced for another reason.	→ The door seal can be replaced. It can be replaced without the need for special tools.	▶ Contact Customer Service. (see 10.4 Customer Service)
The appliance builds up too much ice or condensation.	→ The door seal may have slipped out of its groove.	▶ Check that the door seal is well fitted in the groove.
The exterior surfaces of the appliance are warm.*	→ The heat of the refrigeration circuit is used to avoid condensation.	▶ This is normal.

## 10.4 Customer Service

First check whether you can rectify the fault yourself (see 10 Customer help) . If you cannot rectify the problem, contact Customer Service.

You can find the address at [home.liebherr.com/service](http://home.liebherr.com/service).



### WARNING

Unprofessional repair!  
Injuries.

- ▶ Have any repairs and action - not expressly specified - on the appliance and mains cable carried out by service personnel only. (see 9 Maintenance)
- ▶ A damaged mains cable may only be replaced by the manufacturer, the manufacturer's Customer Service or a similarly qualified person.
- ▶ In the case of appliances with an IEC connector, the change may be made by the customer.

### 10.4.1 Contacting Customer Service

Make sure that the following appliance information is available:

- Appliance name (model and index)
- Service no. (Service)
- Serial no. (S no.)
- ▶ Call up the appliance information via the display. (see Device information)
- or-
- ▶ Refer to the type plate for appliance information. (see 10.5 Model plate)
- ▶ Note down the appliance information.
- ▶ Notify customer service: Report errors and the appliance information.
- ▶ This will help us to provide you with a faster, more accurate service.
- ▶ Follow further instructions from Customer Service.

## 10.5 Model plate

The model plate is behind the drawers on the inside of the appliance.

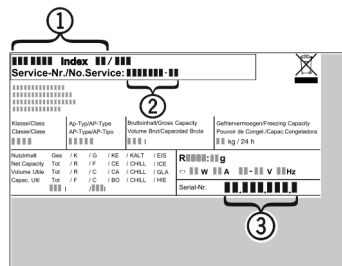

Fig. 83

- (1) Appliance description
- (2) Service no.
- (3) Serial no.

▶ Note the data on the model plate.

## 11 Shutting down

- ▶ Empty the appliance.
- ▶ Switch off appliance. (see Switching the appliance off and on)
- ▶ Pull the mains plug out of the socket.
- ▶ Remove the IEC socket if required: Pull the IEC socket out of the appliance plug and move it to the left and right at the same time.
- ▶ Place a towel in front of the appliance to catch any drops of water that may run out.
- ▶ Clean appliance. (see 9.3 Cleaning the appliance)
- ▶ Leave the door open, so that no unpleasant odours arise.

## 12 Disposal

### 12.1 Preparing appliance for disposal



Liebherr uses batteries in some of its appliances. In the EU, for environmental reasons, legislation obliges the end user to remove these batteries before disposing of old appliances. If your appliance contains batteries, a corresponding notice is attached.

**Lamps** If you can remove the lamps yourself without destroying them, also remove these before disposal.

- ▶ Take the appliance out of operation.
- ▶ If possible: remove lamps without destroying them.

# Disposal

---

## 12.2 Disposing of the appliance in an environmentally friendly manner



The appliance still contains valuable materials and must be disposed of separately from unsorted municipal waste.



**Li-Ion**



**Li-Ion**

Dispose of batteries separately from the old appliance. To do this, you can return the batteries free of charge to retailers as well as recycling centres and collection centres for recyclable materials.

Lamps

Dispose of removed lamps via the respective collection systems.



### **WARNING**

Leaking coolant and oil!  
Fire. The coolant contained in the appliance is eco-friendly, but also flammable. The oil contained in the appliance is flammable. Escaping coolant and oil can ignite if the concentration is high enough and in contact with an external heat source.

- ▶ Do not damage the pipelines of the coolant circuit and the compressor.
- 
- ▶ Observe the notes on transporting the appliance.
  - ▶ Transport the appliance without damaging it.
  - ▶ Dispose of batteries, lamps and the appliance according to the above specifications.





[home.liebherr.com/fridge-manuals](https://home.liebherr.com/fridge-manuals)

**EN** freezer

Issue date: 20260420

**Part number index: 7088537-00**

Liebherr-Hausgeräte GmbH  
Memminger Straße 77-79  
88416 Ochsenhausen  
Deutschland