

Operating and installation instructions



[home.liebherr.com/
fridge-manuals](https://home.liebherr.com/fridge-manuals)





LIEBHERR













EN

ORIGINAL OPERATOR'S MANUAL

LIEBHERR





Contents

1	Safety information and warnings.....	3
1.1	Intended use.....	3
1.2	Climate classes.....	3
1.3	User group.....	3
1.4	Installation and commissioning.....	3
1.5	Safe handling of the appliance.....	3
1.6	Cleaning.....	4
1.7	Faults, damage and repairs.....	4
1.8	Disposal.....	4
1.9	Conformity.....	4
1.10	SVHC substances in accordance with the REACH Regulation.....	4
1.11	EPREL database.....	4
1.12	Open source licences.....	4
1.13	Spare parts.....	4
1.14	Symbols on the appliance.....	4
1.15	Warning levels.....	5
2	Appliance at a glance.....	5
2.1	Scope of delivery.....	5
2.2	Overview of appliances and equipment.....	5
2.3	SmartDevice.....	5
3	Setting up and connecting.....	6
3.1	Installation requirements.....	6
3.2	Integration into a kitchen unit.....	6
3.3	Appliance dimensions.....	6
3.4	Ventilation requirements.....	7
3.5	Connection dimensions for the power supply.....	7
3.6	Transporting the appliance.....	7
3.7	Unpacking the appliance.....	8
3.8	Explanation of symbols used.....	8
3.9	Door hinge change.....	9
3.10	Mounting wall spacers*.....	14
3.11	Setting up the appliance.....	14
3.12	Setting up the appliance so that it is level.....	14
3.13	After setting up.....	15
3.14	Installing multiple appliances.....	15
3.15	Integrating the appliance into a kitchen unit.....	15
3.16	Disposing of packaging.....	16
3.17	Connecting the appliance to the power supply.....	16
4	Functionality of the Touch & Swipe display.....	17
4.1	Navigation and symbol explanation.....	17
4.2	Menus.....	17
4.3	Sleep mode.....	18
5	Putting into operation.....	18
5.1	Switching on appliance (first use).....	18
6	Storage.....	18
6.1	Information regarding storage.....	18
6.2	BioFresh.....	18
6.3	Storage times.....	19
7	Saving energy.....	19
8	Controls.....	20
8.1	Controls and displays.....	20
8.1.1	Status display.....	20
8.1.2	Display symbols.....	20
8.2	Appliance functions.....	20
8.2.1	Notes on the appliance functions.....	20
	Switching the appliance off and on.....	20
		
	Temperature.....	20
	BioFresh B-Value	21
	SabbathMode.....	21

	HumidityPlus	21
	CleaningMode.....	22
	Input lock.....	22
	Language.....	23
	Temperature unit.....	23
	Display brightness.....	23
	WiFi.....	23
	Device information.....	24
	Software.....	25
	Door alarm.....	25
	Demo mode.....	25
	Resetting to factory settings.....	26
8.3	Messages.....	26
8.3.1	Overview of warnings.....	26
8.3.2	Ending warnings.....	26
8.3.3	Overview of reminders.....	27
9	Features.....	27
9.1	Drawers.....	27
10	Maintenance.....	27
10.1	Disassembling / assembling pull-out systems.....	27
10.2	Defrosting the appliance.....	28
10.3	Cleaning the appliance.....	28
11	Customer help.....	29
11.1	Technical specifications.....	29
11.2	Operating noises.....	29
11.3	Technical fault.....	29
11.4	Customer Service.....	30
11.5	Model plate.....	31
12	Shutting down.....	31
13	Disposal.....	31
13.1	Preparing the appliance for disposal.....	31
13.2	Disposing of the appliance in an environmentally friendly manner.....	31

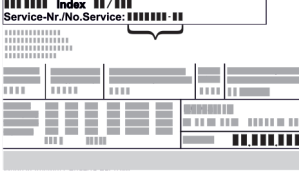
The manufacturer is continually working on the further development of all types and models. Please be aware that we reserve the right to make changes to the shape, equipment and technology.

Symbol	Explanation
	Read instructions Please read the information in these instructions carefully to understand all of the benefits of your new appliance.

Symbol	Explanation
	<p>Additional information on the Internet</p> <p>The digital manual with additional information and in other languages can be found via the QR code on the front of the manual or by entering the service number at home.liebherr.com/fridge-manuals.</p> <p>The service number can be found on the serial tag:</p>  <p style="text-align: center;"><i>Fig. Example illustration</i></p>
	<p>Check appliance</p> <p>Check all parts for transport damage. If you have any complaints, please contact your agent or customer service.</p>
	<p>Differences</p> <p>These instructions apply to a range of models, so differences are possible. Sections that apply to certain models only are marked with an asterisk (*).</p>
	<p>Instructions and results</p> <p>Instructions are marked with a ►.</p> <p>Results are marked with a ▷.</p>
	<p>Videos</p> <p>Videos about the appliances are available on the YouTube channels of Liebherr-Hausgeräte.</p>

Open source licences:

The appliance contains software components that use open source licences. Information on the open source licences used can be found here: home.liebherr.com/open-source-licences

This user information applies to the following appliances:

RB..	42..i
------	-------

1 Safety information and warnings

Keep this user information in a safe place so that you can refer to it at any time.

If you pass on the appliance, pass this user information on to subsequent owners.

To use the appliance properly and safely, read this user information carefully before installation and use. Always follow the instructions, safety instructions and warnings contained therein. They are important so that you can install and operate the appliance safely and properly.

1.1 Intended use

This appliance is intended for household use and similar applications such as:

- in staff kitchen areas in shops, offices and other work areas
- in agricultural environments and by guests in hotels, motels and other accommodation

- in bed and breakfasts
- in catering and similar wholesale operations

Further uses:

- This appliance is not suitable for freezing food.

All other types of application are impermissible.

1.2 Climate classes

Depending on its climate class, the appliance is designed for operation within certain ambient temperature limits. The climate class for your appliance is printed on the type plate.

Note

- In order to guarantee fault-free operation comply with the specified ambient temperatures.

Climate class	for ambient temperatures from
SN	10 °C to 32 °C
N	16 °C to 32 °C
ST	16 °C to 38 °C
T	16 °C to 43 °C
SN-ST	10 °C to 38 °C
SN-T	10 °C to 43 °C

1.3 User group

- This appliance can be used by children aged from 8 years and above and persons with reduced physical, sensory or mental capabilities or lack of experience and knowledge if they have been given supervision or instruction concerning use of the appliance in a safe way and understand the hazards involved.
- Children must not play with the appliance.
- Children must not carry out cleaning and user maintenance without supervision.
- Children aged from 3 to 8 years are allowed to load and unload refrigerating appliances.

1.4 Installation and commissioning

- Only set up and connect the appliance in accordance with the instructions in the user information.
- Do not close the ventilation openings in the appliance housing or in the installation housing.
- Do not damage the mains cable. The appliance must not be operated with a defective mains cable.
- Do not place portable multiple sockets or power supply units at the rear of the appliance.
- It must be easy to access the socket so that the appliance can be quickly disconnected from the power supply in case of an emergency. It must not be behind the appliance.

1.5 Safe handling of the appliance

- Do not store any explosive substances, such as aerosol containers with flammable propellant gas, in the appliance. These types of aerosol can be identified by the list of contents printed on it, or by a flame symbol. Any leaking gas may ignite due to electrical parts.
- Keep burning candles, lamps and other objects with naked flames away from the appliance, so that these do not set fire to the appliance.
- Alcoholic beverages and other containers bearing alcohol must be sealed tight for storage. Any leaking alcohol may ignite due to electrical parts.

Safety information and warnings

- Avoid prolonged skin contact with cold surfaces or with cold/frozen food. Use gloves for protection, for example.
- The refrigerant contained (information on the type plate) is environmentally friendly but flammable. Leaking refrigerant may ignite.
 - Do not damage the refrigeration circuit.
 - Do not use any ignition sources inside the appliance.
 - Do not use electrical appliances inside the appliance (e.g. steam cleaners, heaters).
 - If the refrigerant leaks: remove any naked flames or ignition sources from the vicinity of the leakage point. Properly air the room. Inform customer service.
- Only open the door for a short time. This prevents the temperature inside the appliance from rising.
- Do not reach between the door and the appliance when opening and closing. Fingers may become trapped.
- The temperature in the warmest part of the appliance may be higher than the set temperature.

1.6 Cleaning

- Regularly clean surfaces that come into contact with food.
- Do not use an electric heater or steam cleaner, naked flames or defrost spray to speed up the defrosting process.
- Do not remove the ice with sharp objects.

1.7 Faults, damage and repairs

- If the mains connection cable of the appliance is damaged, replace the mains connection cable.
- Repairs and interventions on the appliance may only be carried out by the customer service or by other qualified personnel trained for this purpose.
- In the event of malfunctions and appliance faults, pull out the mains plug or switch off the fuse. Always hold the plug when pulling out the mains plug. Never tug on the cable.

1.8 Disposal

- The appliance contains valuable materials and is marked with the appropriate symbol. (see 1.14 Symbols on the appliance)
 - Do not dispose of the appliance in the household waste.
 - Dispose of the appliance free of charge at your local recycling centre using the Class 1 collection containers.
 - When purchasing a new appliance, return the old appliance to the retailer free of charge.
 - Provide information about return options.
- Your appliance may contain personal data.
 - Delete personal data before disposal.
- The appliance contains refrigerant (information on the type plate) and oil. The refrigerant inside the appliance is environmentally friendly, but flammable. The oil it contains is also flammable. Escaping refrigerant and oil can ignite in high concentrations and in contact with an external heat source.
 - Do not damage the refrigeration circuit.
 - Only dispose of the appliance in accordance with the instructions in the user information.

1.9 Conformity

The coolant circuit has been tested for leak-tightness. The appliance complies with the relevant safety regulations and directives.

For the EU market: The appliance complies with Directive 2014/53/EU.

For GB market: The appliance complies with the Radio Equipment Regulations 2017 SI 2017 No. 1206.

The full text of the EU Declaration of Conformity is available at the following web address: www.liebherr.com

The BioFresh compartment fulfils the requirements of a chiller compartment in accordance with DIN EN 62552:2020.

1.10 SVHC substances in accordance with the REACH Regulation

You can use the following link to check whether your appliance contains SVHC substances in accordance with the REACH Regulation:

home.liebherr.com/en/en/liebherr-experience/sustainability/environment/scip/scip.html

1.11 EPREL database

From 1 March 2021, the information on energy labelling and eco-design requirements will be available in the European product database (EPREL). The product database can be accessed via the following link <https://eprel.ec.europa.eu/>. Here, you are asked to enter the model identifier. You will find the model identifier on the type plate.

1.12 Open source licences



The appliance contains software components that use open source licences. Information on the open source licences used can be found here:

home.liebherr.com/open-source-licences

1.13 Spare parts

The spare parts availability for functional parts and stockable parts of the equipment is 15 years.

1.14 Symbols on the appliance

	This symbol may be found on the compressor. It pertains to the oil in the compressor and indicates the following danger: Can be fatal if swallowed or with penetration of the respiratory tract. This information is only significant for recycling. No risk exists with normal use. Do not remove this symbol.
	Warning: Fire hazard due to flammable substances. This symbol is located on the compressor and can also be found in other places on the appliance. This symbol warns of flammable substances. Do not remove this symbol.
	This or a similar symbol may be on the rear of the appliance. It indicates that there are vacuum insulation panels (VIP) or perlite panels in the door and/or housing. This information is only significant for recycling. Do not remove this symbol.

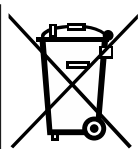

This symbol is located on the type plate. It indicates that the appliance contains valuable materials and that you must not dispose of it with household waste. (see 1.8 Disposal)

1.15 Warning levels

DANGER	Identifies an immediately dangerous situation that will result in death or serious bodily injuries if it is not prevented.
WARNING	Identifies a dangerous situation that could result in death or serious bodily injury if it is not prevented.
CAUTION	Identifies an immediately dangerous situation that could result in slight or moderate injuries if it is not prevented.
ATTENTION	Identifies a hazardous situation that could result in property damage if it is not prevented.
Note	Identifies useful information and tips.

2 Appliance at a glance

2.1 Scope of delivery

Check all parts for transport damage. Contact your dealer or customer service in the event of complaints. (see 11.4 Customer Service)

Your new appliance comes with the following parts:

- Standalone appliance
- Features (depending on the model)
- Installation materials (depending on the model)
- "Quick Start Guide"
- "Installation Guide"*
- Service Brochure

2.2 Overview of appliances and equipment



Fig. 1 Example illustration

- | | |
|-----------------------|---|
| (1) Controls | (3) BioFresh safe |
| (2) Type plate | (4) Adjustable feet (front), transport castors (rear), transport handles at the top (rear) and at the bottom (front) |

2.3 SmartDevice

SmartDevice is the networking solution for your full-space BioFresh appliance.

If your appliance SmartDevice-enabled or compatible, you can quickly and easily connect your appliance to your WiFi. With the SmartDevice app, you can operate your appliance from a mobile device. Additional functions and setting options are available in the SmartDevice SmartDevice app.

SmartDevice-enabled appliance: Your appliance is capable of being a SmartDevice. To be able to connect your device to WiFi, you need to download the SmartDevice app.

More information about SmartDevice: smartdevice.liebherr.com

Setting up and connecting

Downloading the SmartDevice app:



After installing and configuring the SmartDevice app, you can connect your appliance to your Wi-Fi (see WiFi) using the SmartDevice app and the appliance's Wi-Fi function.

Note

The SmartDevice function is not available in the following countries: Russia, Belarus, Kazakhstan.

3 Setting up and connecting

3.1 Installation requirements

The installation conditions are crucial to ensure that you can operate your appliance safely, efficiently and without problems.

- Observe all safety instructions.
- Consider the location and position in the room.



WARNING

Danger of fire due to incorrect positioning!

If the mains cable or plug touches the back of the appliance, the vibration can damage the mains cable or the plug resulting in a short circuit.

- ▶ Make sure the mains cable is not trapped under the appliance when you position the appliance.
- ▶ Stand the appliance so that it is not touched by connectors or main cables.
- ▶ Do not connect any appliances to sockets in the area of the back of the appliance.
- ▶ Do **not** place and operate multi-sockets/power distributors and other electronic devices (such as halogen transformers) at the back of the appliances.



WARNING

Fire hazard due to dampness!

If live parts or the mains lead become damp this may cause short circuits.

- ▶ The appliance is designed for use in enclosed areas. Do not operate the appliance outdoors or in areas where it is exposed to splash water or damp conditions.



WARNING

Leaking coolant and oil!

Fire. The coolant contained in the appliance is eco-friendly, but also flammable. The oil contained in the appliance is flammable. Escaping coolant and oil can ignite if the concentration is high enough and in contact with an external heat source.

- ▶ Do not damage the pipelines of the coolant circuit and the compressor.

3.1.1 Installation site

- Only set up and use the appliance in enclosed spaces.
- A dry and well-ventilated room is an optimum installation location.

- If the appliance is installed in a very damp environment, condensation may form on the appliance exterior. Always make sure there is good ventilation and aeration at the installation site.
- The more refrigerant there is in the appliance, the larger than room must be in which it is located. In rooms that are too small, a leak can produce a flammable gas/air mixture. For every 8 g of refrigerant, the installation room must be at least 1 m³ in size. Information on the refrigerant contained is given on the type plate inside the appliance.
- The floor on which the appliance stands must be horizontal and level.

3.1.2 Position in space

- Do not place the appliance in direct sunlight or near radiators or similar sources of heat.
- You can place the appliance directly next to an oven.
- If the appliance is placed directly next to an oven, the energy consumption may increase slightly. This is dependent on the service life and usage intensity of the oven.
- Always position the appliance with the rear directly against the wall, or with wall spacer brackets attached (see below) then with these directly against the wall.*
- Always position the appliance with the rear directly on the wall.*
- Use in hazardous areas is not permitted.

3.2 Integration into a kitchen unit

- You can convert the appliance with kitchen cabinets.

3.3 Appliance dimensions

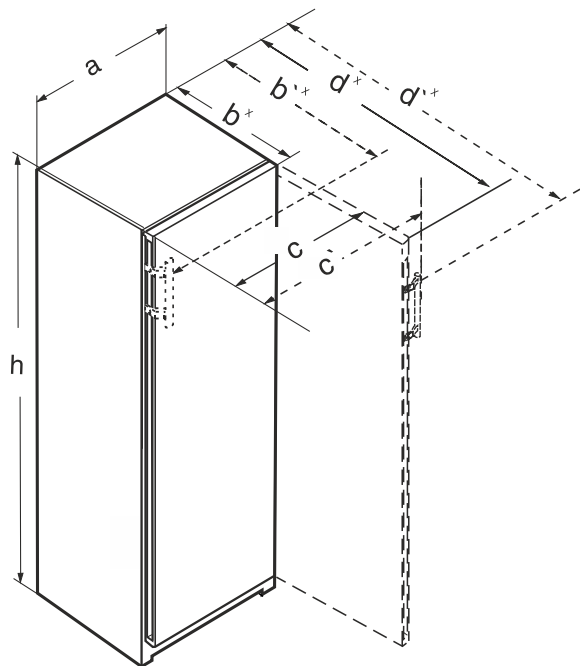

Fig. 2

(a) Appliance width

(b) Appliance depth

(c) Appliance width with door open

(d) Appliance depth with door open

(') Dimensions with lever handle

3.3.1 Dimensions with lever handle

RBa30 425i / FN.. 42..	
a (mm)	597
b (mm)	719 ^x
c (mm)	654
d (mm)	1222 ^x
h (mm)	1255

With lever handle

	FN.. 46..	FN.. 66..
a (mm)	597	698
b (mm)	719 ^x	804 ^x
c (mm)	654	754
d (mm)	1222 ^x	1408 ^x
h (mm)	1455	1455

With lever handle

	FN.. 50.. / LTGN-235	FN.. 70..
a (mm)	597	698
b (mm)	719 ^x	804 ^x
c (mm)	654	754
d (mm)	1222 ^x	1408 ^x
h (mm)	1655	1655

With lever handle

	(S)FN.. 52.. / LTGN-270	FN.. 72..
a (mm)	597	698
b (mm)	719 ^x	804 ^x
c (mm)	654	754
d (mm)	1222 ^x	1408 ^x
h (mm)	1855	1855

With lever handle

^x This dimension increases by 15 mm on appliances with attached wall spacer brackets. (see 3.10 Mounting wall spacers*)

3.4 Ventilation requirements

NOTICE

Danger of overheating due to insufficient air ventilation! The compressor may be damaged if there is insufficient air ventilation.

- ▶ Take care to ensure adequate air ventilation.
- ▶ Observe the ventilation requirements.

If the appliance is integrated into a kitchen unit, the following ventilation requirements must be observed:

- As a general rule: the larger the ventilation cross section, the more energy the appliance will be able to save.

Note

If the spacing between the rear of the appliance and the wall is less than 51 mm, energy consumption may increase.*

3.5 Connection dimensions for the power supply

The connection to the power supply is on the rear of the appliance. To connect your appliance safely, ensure that the following requirements are met:

- ❑ Dimensions for the connection to the power supply are known and are adhered to. See table below.
- ❑ Connection to the power supply according to the instructions. (see 3.17 Connecting the appliance to the power supply)

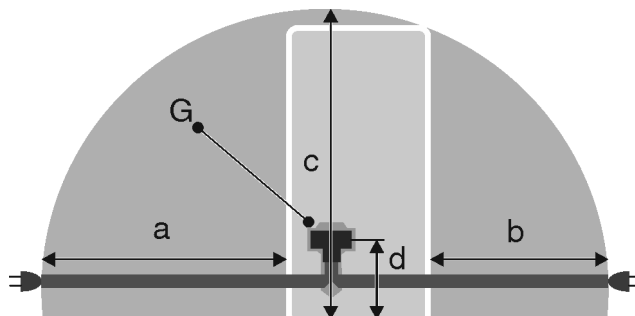

Fig. 3 Fridge/freezer combinations / freezers / full-capacity BioFresh appliances

- (a) Maximum available length of the mains connection cable
- (b) Maximum available length of the mains connection cable
- (c) Maximum available vertical length of the mains connection cable
- (d) Gap between appliance plug and floor
- (G) Appliance plug

For 600 mm wide appliances:	
a	~ 1800 mm
b	~ 1400 mm
c	~ 2100 mm
d	~ 200 mm

3.6 Transporting the appliance

3.6.1 Transporting the appliance for initial use

Ensure that the following requirements are met:

- ❑ The appliance is packaged.
- ❑ The appliance is upright.

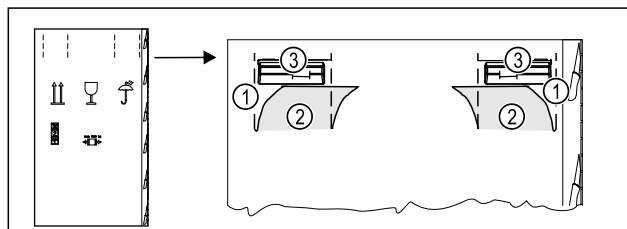

Fig. 4

- ▶ Press the packaging cardboard into the perforation Fig. 4 (1) at the top.
- ▶ Pull out any tabs Fig. 4 (2) that have been pushed in.
- ▶ Carrying handle Fig. 4 (3) visible on the right and left.
- ▶ Hold the appliance by the carrying handles Fig. 4 (3).
- ▶ Transport the appliance with the help of two people.
- ▶ Unpacking the appliance. (see 3.7 Unpacking the appliance)

Setting up and connecting

3.6.2 Transporting the appliance after initial use

Observe the following instructions if you wish to transport or move the appliance again after initial use.

Ensure that the following requirements are met:

- The appliance is emptied.
- The appliance is upright.
- Appliance with door(s): Door is secured against accidental opening.
- Appliance with telescopic unit: The telescopic unit is secured against accidental opening.
- Appliance with adjustable feet: Adjustable feet are screwed in.
- ▶ Hold the appliance by the carrying handles.
- ▶ Transport the appliance with the help of two people.

After transport:

- ▶ Unscrew the adjustable feet on the appliance.
- ▶ Align the appliance. (see 3.12 Setting up the appliance so that it is level)

3.7 Unpacking the appliance





Before you connect the appliance, report any damage immediately to the delivery company.

- ▶ Check the appliance and the packaging for damage during transport. Contact the supplier immediately if you suspect any level of damage.
- ▶ Remove all materials from the back or the side walls of the appliance that may prevent proper installation or ventilation.
- ▶ Remove all protective films from the appliance. Do not use sharp or pointed objects for this.

3.8 Explanation of symbols used

	There is a danger of injury during this step! Observe the safety instructions!
	The instruction is valid for several models. Only perform this step if it applies to your appliance.
	For installation, please refer to the detailed description in the text section of the instructions.
	Section is valid for either a single-door appliance or a double-door appliance.
	Choose between the following options: Appliance with door hinge on the right or appliance with door hinge on the left.
	Installation step required for IceMaker and/or InfinitySpring.

	Only loosen or lightly tighten the screws.
	firmly tighten the screws.
	Check whether the following step is necessary for your model.
	Check that the components used are correctly installed/fitted.
	Measure the specified dimension and correct if necessary.
	Tool for installation: Metre stick
	Tool for installation: Cordless screwdriver and use A lengthwise bit insert is recommended for good access to the screws.
	Tool for installation: Spirit level
	Tool for installation: Open-end wrench with AF 7 and AF 10
	Two people are required for this step.
	The step takes place at the marked location on the appliance.
	Aid for installation: String
	Aid for installation: Protractor

	Aid for installation: Screwdriver
	Aid for installation: Scissors
	Aid for installation: Marking pen, wipeable
	Included: Remove components
	Dispose of components that are no longer required in accordance with local regulations.

3.9 Door hinge change

Tools

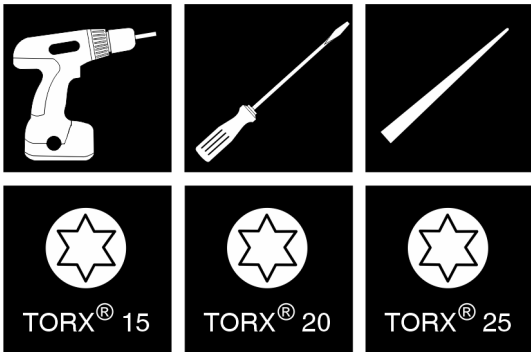

Fig. 5

NOTICE

Risk of damage due to door collision!
Damage to the appliances with Side-by-Side positioning. If you set up two appliances next to each other in a specific Side-by-Side arrangement, the door hinge of both appliances is preset at the factory.

- ▶ Side-by-Side positioning: Do not change the door hinge.

These sections apply for appliances **without a soft stop mechanism**:

- For appliances **without** a soft stop mechanism
- For all appliances

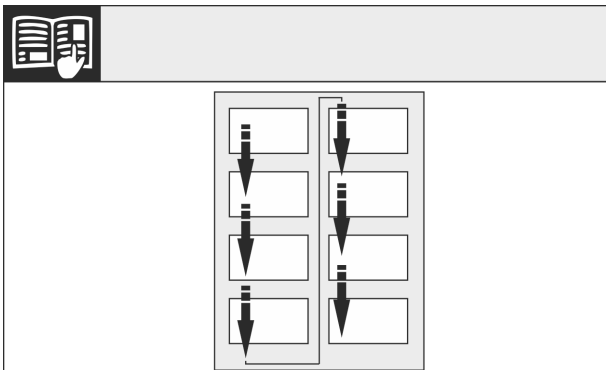

Fig. 6

Remember the reading direction.

3.9.1 Appliances without closing damper: Removing covers

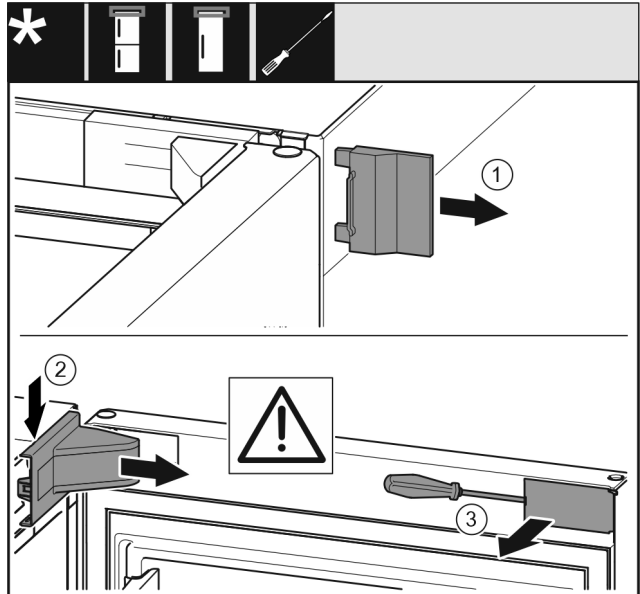

Fig. 7

- ▶ Open the door.
- ▶ Remove the outer cover (1).
- ▶ Disengage and remove the swap bearing block cover (2).

NOTICE

Risk of damage from screwdrivers!
If you damage the door seal, the door will not close properly resulting in inadequate cooling.

- ▶ Use a screwdriver carefully as an aid.
- ▶ Do not damage the door seal with the screwdriver.
- ▶ Use a screwdriver to disengage the cover (3) on the outside of the door and swivel it to the side.

Setting up and connecting

3.9.2 Detaching the door

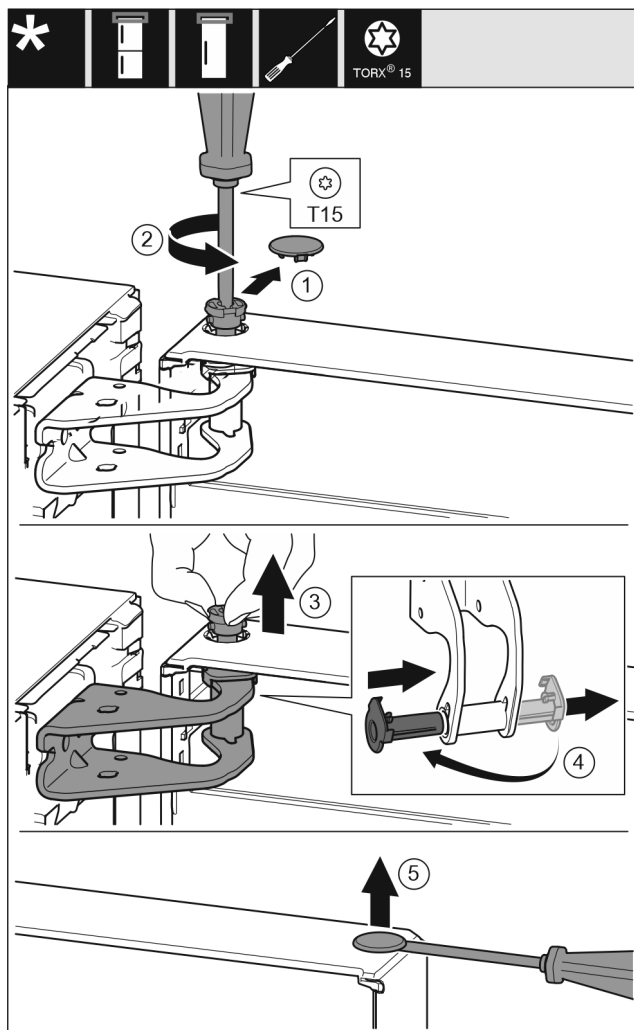

Fig. 8

- ▶ Carefully remove the cover (1).
- ▶ Use screwdriver to loosen the bolts (2) a little.



CAUTION

Danger of injury due to door tipping out!
If you remove the bolt on the door completely, the door may tilt out and you may injure yourself.

- ▶ Hold the door firmly before removing the bolt.
- ▶ Hold door in place.
- ▶ Pull out the bolt (3) with your fingers.
- ▶ Pull the bearing bush (4) out of the guide.
- ▶ Insert the bearing bush (4) on the other side and engage.
- ▶ Lift the door and put it to one side.
- ▶ Carefully lift and remove the cover (5) with a screwdriver.

3.9.3 Relocating the upper bearing components

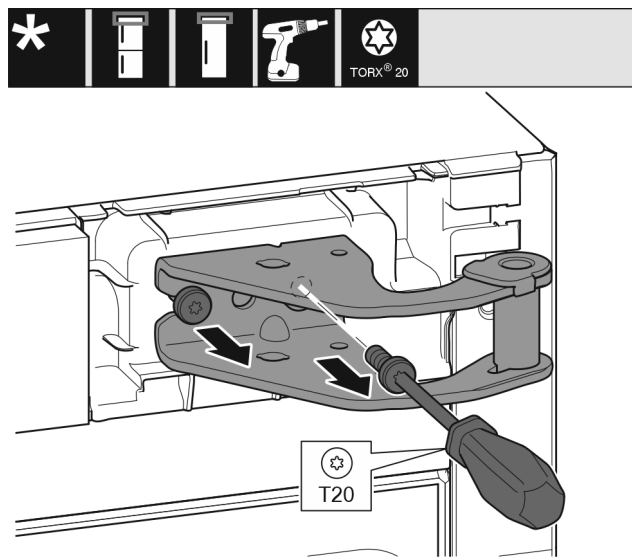

Fig. 9

- ▶ Unscrew the screws.
- ▶ Lift and remove the swap bearing block.



WARNING

Danger of injury due to door falling out!
If the bearing parts are not screwed on tightly enough, the door may fall out. This can result in serious injuries. In addition, the door may not close with the result that the appliance does not cool properly.

- ▶ Screw on the bearing brackets/bearing pins tightly with 4 Nm.
- ▶ Check all screws and retighten them if necessary.

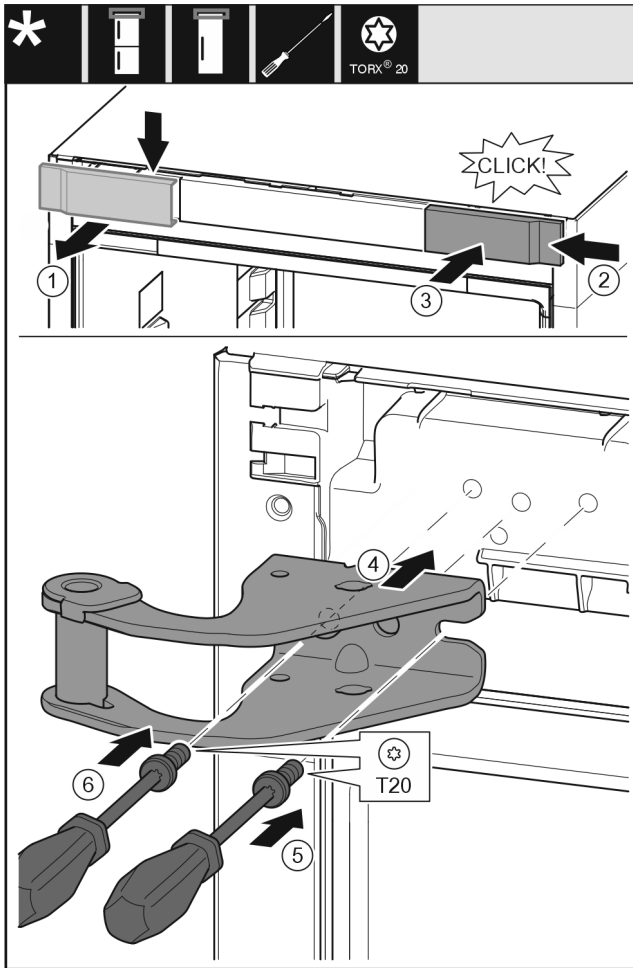

Fig. 10

- ▶ Remove the cover (1) from above towards the front.
- ▶ Turn the cover (2) by 180° and attach to the other side from the right.
- ▶ Engage the cover (3).
- ▶ Place the top swap bearing block (4).
- ▶ Screw the screw (5) tight.
- ▶ Screw the screw (6) tight.

3.9.4 Moving the lower bearing parts to the other side

For all appliances:



WARNING

Danger of injury due to door falling out!
If the bearing parts are not screwed on tightly enough, the door may fall out. This can result in serious injuries. In addition, the door may not close with the result that the appliance does not cool properly.

- ▶ Screw on the bearing brackets/bearing pins tightly with 4 Nm.
- ▶ Check all screws and retighten them if necessary.

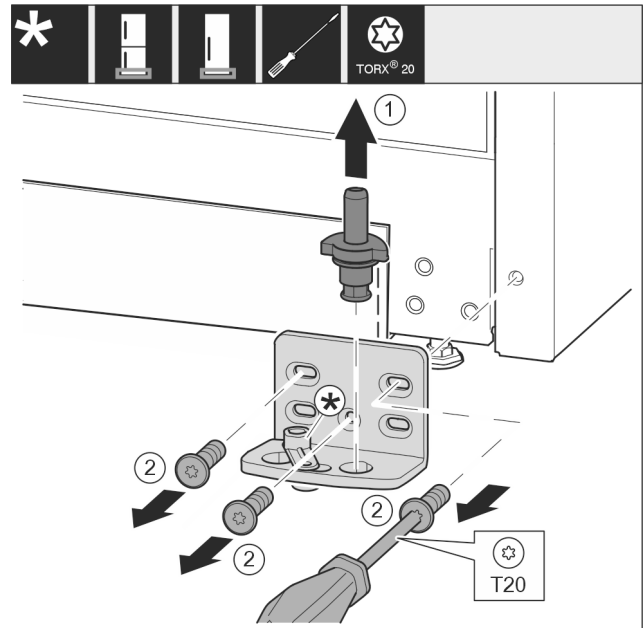

Fig. 11

- ▶ Pull the bearing bolt Fig. 11 (1) out upwards completely.
- ▶ Use screwdriver to unscrew the screws Fig. 11 (2) and remove the swap bearing block.

For appliances without a soft stop:

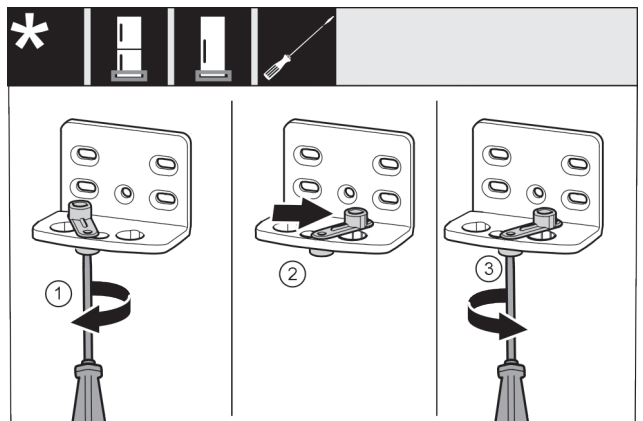

Fig. 12

- ▶ Use screwdriver to loosen the screw Fig. 12 (1).
- ▶ Lift the door closing aid Fig. 12 (2) and turn 90° clockwise in the hole.
- ▶ Tighten screw Fig. 12 (3) with screwdriver.

For all appliances:

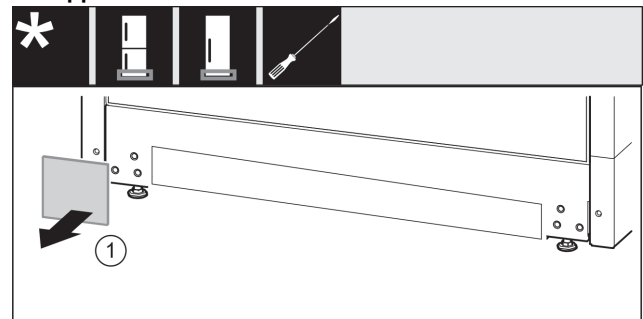

Fig. 13

- ▶ Remove cover Fig. 13 (1).

Setting up and connecting

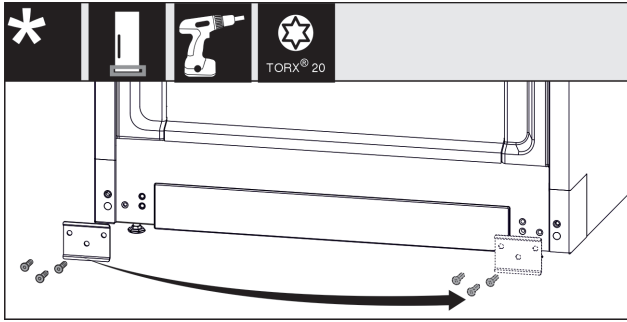

Fig. 14

- Unscrew the plate Fig. 14 (1), move it to the other side and screw it back on.

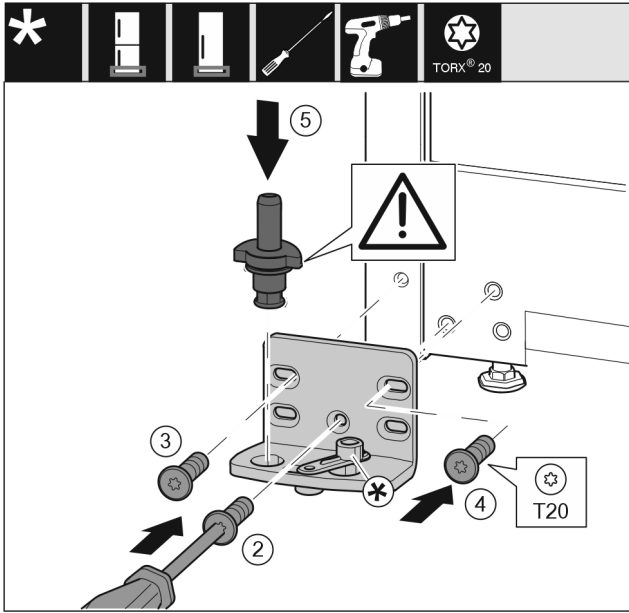

Fig. 15

- Place the swap bearing block on the other side and use a screwdriver to screw it on. Start with the screw Fig. 15 (2) at the bottom in the middle.
- Tighten screw Fig. 15 (3) and screw Fig. 15 (4).
- Insert the bearing bolt Fig. 15 (5) completely. Ensure that the latching cam is pointing towards the rear.

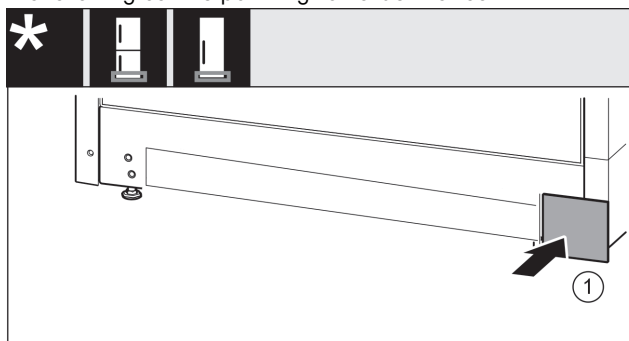

Fig. 16

- Re-attach the cover Fig. 16 (1) to the other side.

3.9.5 Moving the door bearing parts to the other side

For appliances without a soft stop:



WARNING

Danger of injury due to door falling out!

If the bearing parts are not screwed on tightly enough, the door may fall out. This can result in serious injuries. In addition, the door may not close with the result that the appliance does not cool properly.

- Screw on the bearing brackets/bearing pins tightly with 4 Nm.
- Check all screws and retighten them if necessary.

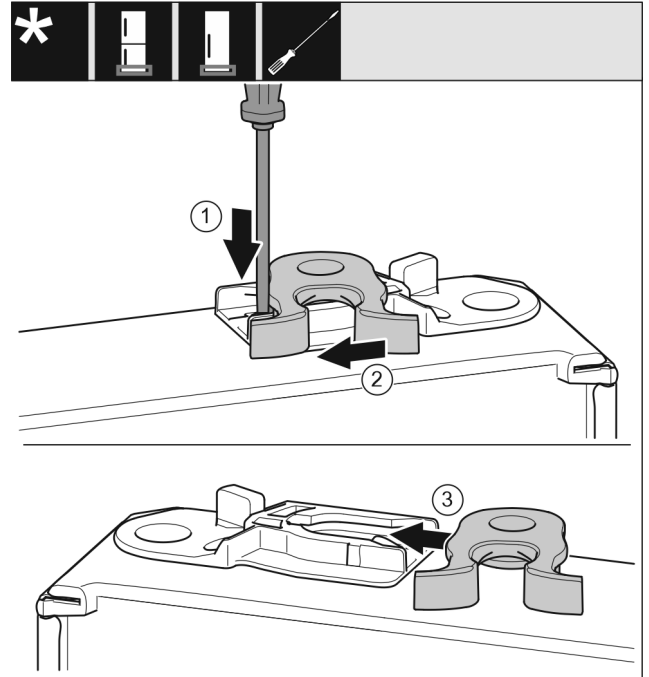

Fig. 17

- The bottom side of door faces upwards: Turn the door.
- Use a slotted screwdriver to push the tab Fig. 17 (1) downwards.
- Pull the closing hook Fig. 17 (2) out of the guide.
- Insert the closing hook Fig. 17 (3) into the guide on the other side.
- The upper side of door faces upwards: Turn the door.

3.9.6 Moving the handles to the other side

For all appliances:

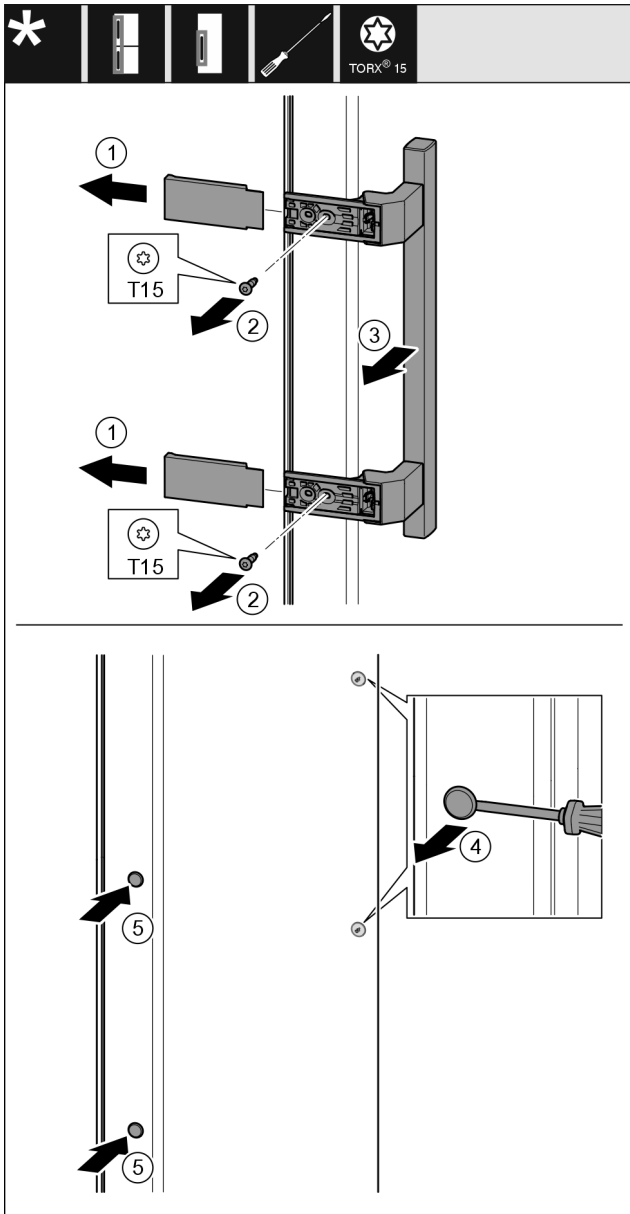

Fig. 18

- ▶ Remove the cover Fig. 18 (1).
- ▶ Unscrew screws Fig. 18 (2) with screwdriver.
- ▶ Remove the handle Fig. 18 (3).
- ▶ Use a slotted screwdriver to lift the side plug Fig. 18 (4) carefully and pull it out.
- ▶ Re-insert the plug Fig. 18 (5) on the other side.

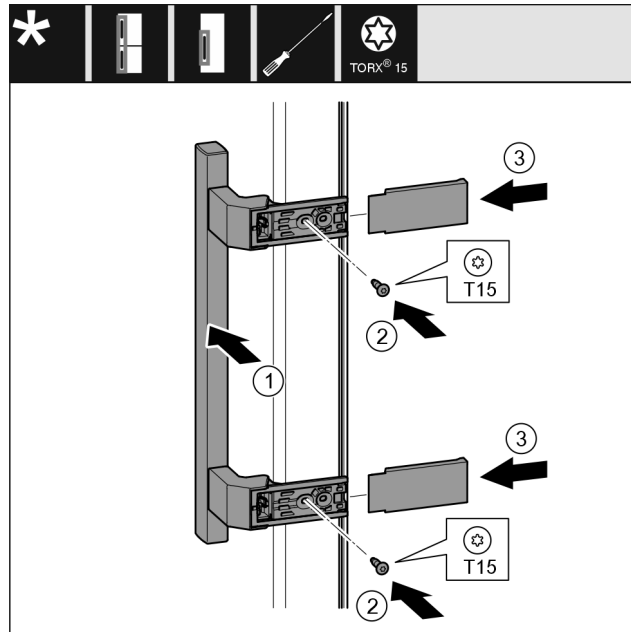

Fig. 19

- ▶ Place the handle Fig. 19 (1) on the opposite side.
- ▶ The screw holes must be exactly above each other.
- ▶ Tighten screws Fig. 19 (2) with screwdriver.
- ▶ Place the covers Fig. 19 (3) on the side and push them on.
- ▶ Ensure that they latch into place.

3.9.7 Fitting the door

- ▶ Place the door on the lower bearing pins.

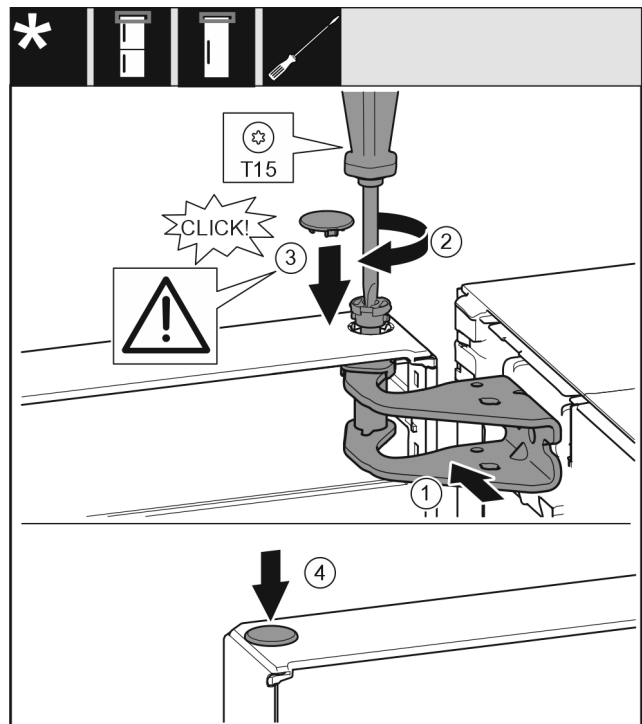

Fig. 20

- ▶ Align the top door with the opening in the swap bearing block Fig. 20 (1).
- ▶ Insert the bolt Fig. 20 (2) and use screwdriver to tighten it.
- ▶ Insert the cover Fig. 20 (3).
- ▶ Check that the cover Fig. 20 (3) is resting on the door.
- ▶ Insert the cover Fig. 20 (4).

Setting up and connecting

3.9.8 Aligning the door

For all appliances:



WARNING

Danger of injury due to door falling out!

If the bearing parts are not screwed on tightly enough, the door may fall out. This can result in serious injuries. In addition, the door may not close with the result that the appliance does not cool properly.

- ▶ Screw the bearing brackets on firmly with 4 Nm.
- ▶ Check all screws and retighten them if necessary.
- ▶ Align the doors flush with the appliance housing using the two slots in the bearing bracket if needed. To do this undo the middle screw in the bottom bearing bracket with the T20 tool supplied. Undo the remaining screws a little with the T20 tool or with a T20 screwdriver and align using the slotted holes.
- ▶ Prop up the door: Take off the adjustable foot on the bearing bracket using the open-ended wrench SW10 until it comes into contact with the floor, then turn an additional 90°.

3.9.9 Fitting the covers

For appliances without a soft stop:

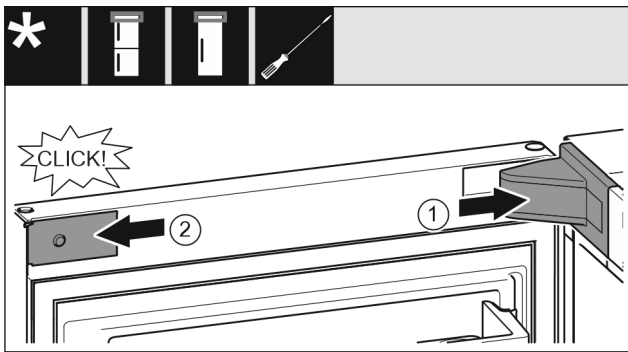

Fig. 21

The door is open 90°.

- ▶ Put the swap bearing block cover Fig. 21 (1) on and engage, push apart carefully if required.
- ▶ Place the trim Fig. 21 (2) on the side and engage.

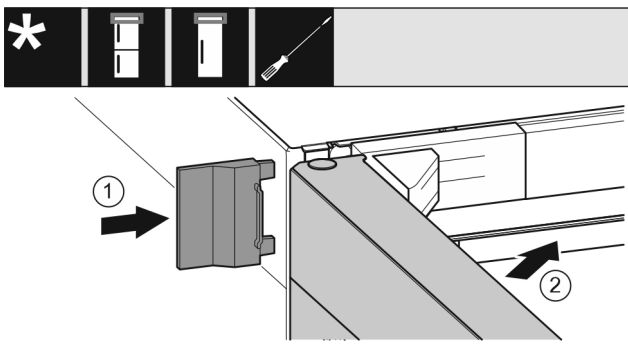
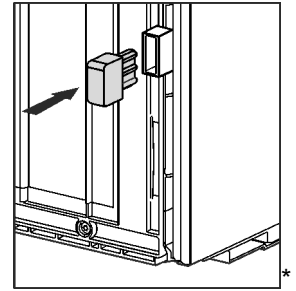

Fig. 22

- ▶ Push the outer cover Fig. 22 (1) on.
- ▶ Close the upper door Fig. 22 (2).

3.10 Mounting wall spacers*

With wall spacers, your device achieves the declared energy consumption and no condensation forms in high ambient humidity. The device is fully functional without the spacer brackets, but its energy consumption will be slightly higher. If you insert the wall spacers, then the device depth increases by approx. 15 mm.*



- ▶ Appliance with enclosed wall spacers: Insert the wall spacers on the rear of the appliance at the bottom left and right.

3.11 Setting up the appliance



CAUTION

Risk of injury due to heavy appliance!

- ▶ Have two people transport the appliance to its installation site.



WARNING

Risk of fire due to short circuit!

- ▶ When you set the appliance up: do not kink, jam or damage the mains cable.
- ▶ The appliance must not be operated with a defective mains cable.



WARNING

Fire hazard and danger of damage!

- ▶ Do not place appliances emitting heat e.g. microwaves, toasters etc. on the appliance!

Ensure that the following conditions are met:

- Only move the device when it is not loaded.
- Only install the appliance with help.
- ▶ Remove the mains cable from the package.
- ▶ Plug the mains cable's IEC socket completely into the appliance plug on the back of the appliance. Ensure that the IEC socket is tight.
- ▶ Use a cord to lay the mains plug to a freely accessible socket if required.

3.12 Setting up the appliance so that it is level

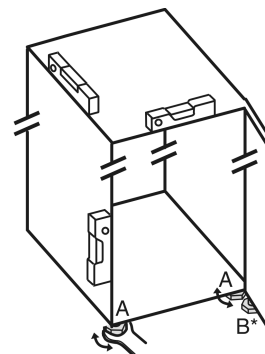

Fig. 23

- ▶ Unscrew the adjustable feet Fig. 23 (A) using the enclosed open-end spanner and a spirit level until the appliance is firmly aligned and level.



CAUTION

Risk of injury and damage due to the appliance tipping over! If the additional adjustable foot on the lower swap bearing block does not rest properly on the floor, the appliance may tip over. This can lead to property damage and injuries.

► Unscrew the additional adjustable foot on the swap bearing block as instructed.

► Unscrew the adjustable foot *Fig. 23 (B)* on the swap bearing block with the enclosed open-end spanner until it rests on the floor.

► Turn the adjustable foot *Fig. 23 (B)* 90° further.

► The appliance is aligned.

3.13 After setting up

- Remove all transport safety components.
- Take off the protective film from the exterior of the appliance.
- Take off the protective film from the trim panels and drawer fronts.*
- Clean the appliance. (see operating instructions)
- Note the type (model, number), appliance designation, appliance/serial number, purchase date and dealer's address.

3.14 Installing multiple appliances

The appliances have been developed for different installation methods. If you wish to install several appliances next to each other or on top of each other, ensure that the following requirements are met:

- Only install appliances next to or on top of each other if they have been developed for this.
- Observe notices and the following table.

NOTICE

Risk of damage due to condensate!

► Do not place the appliance directly next to another cooling/refrigeration unit.

Model	Installation method
All models	Standalone
Models with model designation starting with S...	Side-by-Side (SBS)

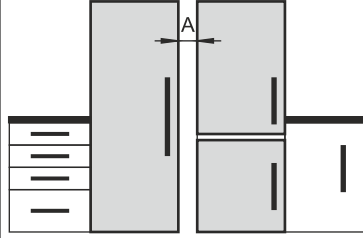
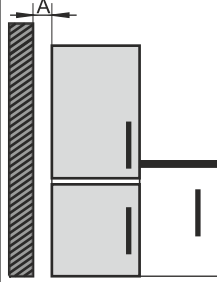
Model	Installation method
Models without side wall heating	 <p>Next to each other: Install with gap A of 70 mm between the appliances.</p> <p>If you do not comply with this gap, condensation will form on the side walls between the appliances.</p>  <p>On an exterior wall: Install with gap A as with installation next to each other.</p> <p>If you do not comply with this gap, condensation may form on the appliance's side wall.</p>

Models and their installation method

Assemble the appliances according to the separate installation instructions.

3.15 Integrating the appliance into a kitchen unit

The appliance can be integrated into a kitchen unit. Please observe the following installation conditions:

- If you fit a stacking cabinet above the appliance, you must allow for a ventilation cross-section with the appropriate depth at the rear of the stacking cabinet.
- If you place the appliance with the hinges next to a wall, you must take the distance to the side of the appliance into account.
- To ensure that the door can be opened fully, the appliance must protrude beyond the front thickness. Depending on the niche depth, the appliance may protrude further.



WARNING

Risk of fire due to short circuit!

- When you set the appliance up: do not kink, jam or damage the mains cable.
- The appliance must not be operated with a defective mains cable.

Ensure that the following requirements are met:

- The socket is easily accessible and is not behind the appliance.
- Ventilation requirements are met. (see 3.4 Ventilation requirements)
- Connection dimensions are taken into account. (see 3.17 Connecting the appliance to the power supply)
- Wall spacers are fitted.*

Setting up and connecting

3.15.1 Niche dimensions for appliances with lever handle

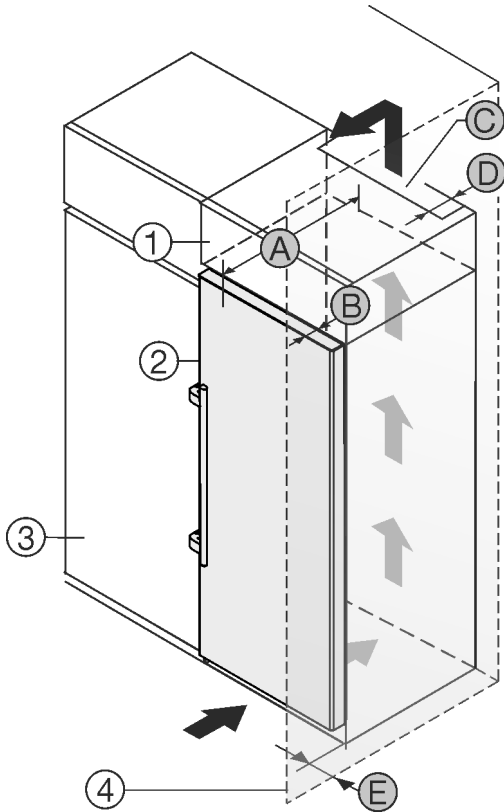

Fig. 24

- (1) Top Unit
- (2) Appliance
- (3) Kitchen cupboard
- (4) Wall
- (A) Appliance depth
- (B) Door depth
- (C) Ventilation cross-section
- (D) Distance from rear of the appliance
- (E) Distance to the side of the appliance

Dimensions with lever handle:	
A	675 mm ^x
B	75 mm
C	min. 300 cm ²
D	min. 50 mm
E	min. 57 mm

^x On devices with wall spacer brackets, this dimension increases by 15 mm.*

3.16 Disposing of packaging



WARNING

Danger of suffocation due to packing material and plastic film!

- ▶ Do not allow children to play with packing material.

The packaging is made of recyclable materials:

- corrugated board/cardboard
- expanded polystyrene parts
- polythene bags and sheets
- polypropylene straps
- nailed wooden frame with polyethylene panel*

- ▶ Take the packaging material to an official collecting point.

3.17 Connecting the appliance to the power supply



WARNING

Danger of electric shock and injury due to damaged appliance or damaged mains cable!

Danger of cuts and fatal injuries. If the appliance or the mains cable is damaged during transport, you may be electrocuted. You could also cut yourself on damaged parts of the appliance housing.

- ▶ Check the appliance and the mains cable for damage after transport.
- ▶ Never put the appliance into operation if the appliance or the mains cable are damaged.
- ▶ Contact Customer Service.

You can connect your appliance to the mains using the power cable supplied separately. The mains power cable has an appliance coupler at one end and a mains plug at the other end.

Make sure that the following requirements are fulfilled:

- The appliance and power cable are undamaged.
- The appliance is set up in accordance with the regulations. (see 3.10 Mounting wall spacers*)
- Requirements for the electrical connection are met.
- Dimensions for connection in accordance with regulations are known and observed. (see 3.5 Connection dimensions for the power supply)
- Mains voltage and frequency correspond to the specifications on the type plate.
- The socket is earthed according to the regulations and fused.
- The fuse tripping current is between 10 A and 16 A.
- The socket is easily accessible and is not behind the appliance. (see 3.5 Connection dimensions for the power supply)

NOTICE

Danger of damage to incorrect operation!
Damage to the electrical components of the appliance.

- ▶ Only use the supplied mains cable.



WARNING

Danger of fire due to incorrect connection!
Burns.

Damage to the appliance.

- ▶ Do not use an extension cable.
- ▶ Do not use distributor blocks.

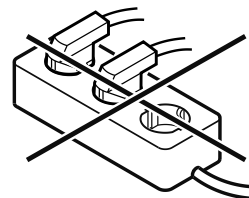

NOTICE

Danger of damage to incorrect connection!
Damage to the appliance.

- ▶ Do not connect the appliance to a stand-alone inverter, e.g. solar power systems and petrol generators.

- ▶ Connect the mains cable plug to the power supply. Ensure that the plug is tightly in the socket.







- ▷ The Liebherr logo appears in the display.
- ▷ The display switches to the standby symbol.
- ▷ If no action occurs within 60 seconds: The standby symbol fades or disappears.
- ▷ The appliance is connected. For information regarding first use, see the following section or the operating instructions.

4 Functionality of the Touch & Swipe display

You operate your appliance using the Touch & Swipe display. You select appliance functions in the Touch & Swipe display (hereafter referred to as display) by tapping them. If you do not perform any action on the display for 10 seconds, the display either jumps back to the higher-level menu or directly to the status display.

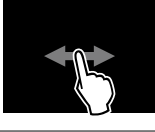
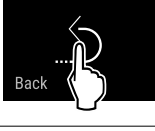
4.1 Navigation and symbol explanation

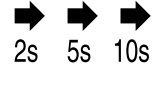
In the illustrations, different symbols are used to navigate the display. The following table describes these symbols.

Symbol	Description
	Briefly touch the display: Activates/deactivates function. Confirms selection. Opens submenu.
	Touch the display for a specified time (e.g. 3 seconds): Activates/deactivates function or value.
	Swipe left or right: Navigate in the menu.
	Briefly touch the Back symbol: Jumps back one menu level.
	Press and hold the Back symbol for 3 seconds: Jumps back to the status display.
	Arrow with clock: It takes more than 10 seconds for the following message to appear in the display.
	Arrow with a time indication: It takes the specified amount of time until the following message appears in the display.
	"Open Settings menu" symbol: Navigates to the Settings menu and opens the settings menu. If necessary: Navigate to the desired function in the Settings menu. (see 4.2.1 Opening the Settings menu)

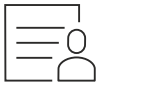
Symbol	Description
	"Open Advanced menu" symbol: Navigates to the Advanced menu and opens the advanced menu. If necessary: Navigate to the desired function in the Advanced menu. (see 4.2.2 Opening the expanded menu)
No action for 10 seconds	If you do not perform any action on the display for 10 seconds, the display either jumps back to the higher-level menu or directly to the status display.
Close the door and open it again.	If you close the door and immediately open it again, the display jumps directly back to the status display.

Note: Illustrations of the display are shown in the English version.

4.2 Menus

The appliance functions are distributed over various menus:

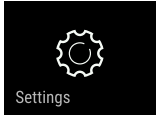
Menu	Description
Main menu	When you switch the appliance on, you are automatically in the main menu. From here you can navigate to the most important appliance functions, to the Settings menu and to the Advanced menu.
 Settings menu	The Settings menu contains additional appliance functions for setting up your appliance.
Advanced menu	The advanced menu contains special appliance functions for setting up your appliance. Access to the Advanced menu is protected by the numerical code 151 .

4.2.1 Opening the Settings menu

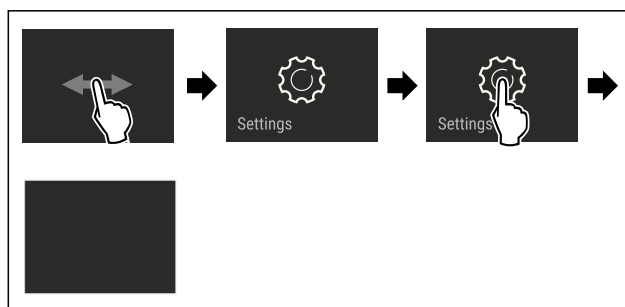

Fig. 25 Example illustration

- ▷ Carry out action steps according to the illustration.
- ▷ Settings menu is open.
- ▷ If necessary: Navigate to the desired function.

4.2.2 Opening the expanded menu



Fig. 26

Putting into operation

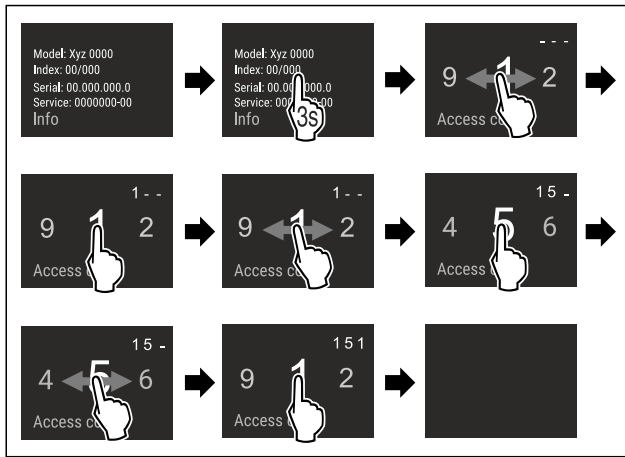

Fig. 27 Example illustration, access with numerical code 151

- ▶ Carry out action steps according to the illustration.
- ▶ The expanded menu is open.
- ▶ If necessary: Navigate to the desired function.

4.3 Sleep mode

If you do not touch the display for 1 minute, the display switches to sleep mode. In sleep mode, the display brightness is dimmed.

4.3.1 Ending sleep mode

- ▶ Touch the display briefly with your finger.
- ▶ Sleep mode is ended.

5 Putting into operation

5.1 Switching on appliance (first use)

Make sure that the following requirements are fulfilled:

- The appliance has been installed and connected in accordance with the installation instructions.
- All adhesive strips, adhesive and protective films and transport locks are removed from inside and on the appliance.
- All marketing leaflets are removed from the drawers.
- You are familiar with the functionality of the Touch & Swipe display. (see 4 Functionality of the Touch & Swipe display)

Switch on the appliance using the Touch & Swipe display:

- ▶ If the display is in sleep mode: Briefly touch the display.
- ▶ Carry out action steps according to the illustration.

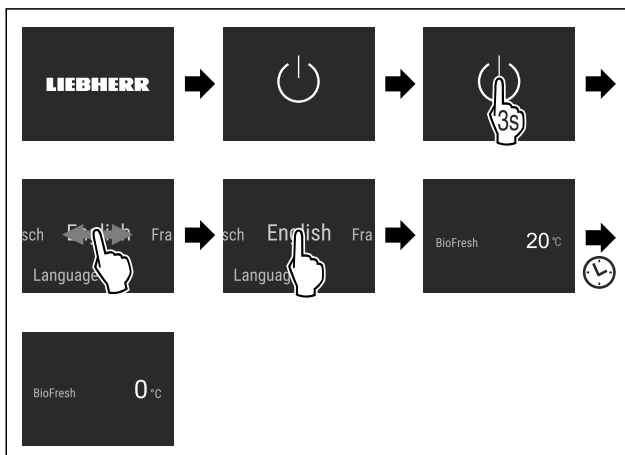

Fig. 28

- ▶ Status display appears.
- ▶ The appliance cools to the temperature set at the factory.
- ▶ The appliance starts in demo mode (status display with DEMO appears): If the appliance starts in demo mode, you can deactivate demo mode within the next 5 minutes. (see Demo mode)

More information:

- Start the SmartDevice for the first time. (see 2.3 Smart-Device) and (see WiFi)

Note

The manufacturer recommends:

- ▶ Stock with food: Wait for around 6 hours until the set temperature is reached.
- ▶ Observe the notes on storing food. (see 6.1 Information regarding storage)

Note

Accessories can be purchased from the Liebherr-Hausgeräte store at home.liebherr.com/shop/de/deu/zubehor.html.

6 Storage

6.1 Information regarding storage



WARNING

Fire hazard from electrical appliances!

If you use electrical appliances in the food area of your appliance, they can cause a fire.

- ▶ Do not use electrical appliances in the food area of the appliance unless recommended by the manufacturer.

Note

The energy consumption increases and the cooling power goes down if ventilation is not sufficient.

- ▶ Always keep air slots clear.

Observe the following specifications for storage:

- Keep the air vents on the fan free.
- Package or cover foods that readily take on or give off odours or taste in closed containers.
- Package raw meat or fish in clean, closed containers. This will prevent meat or fish from touching or dripping onto other food.
- Keep liquids in closed containers.
- Leave space between goods to ensure good air circulation.
- Store food according to the instructions on the packaging.
- Always observe the best-before date indicated on the packaging.

Note

Failure to follow these guidelines can lead to foodstuffs spoiling.

6.2 BioFresh

BioFresh will extend the storage time for some fresh foods compared to traditional refrigeration.

Note

If the temperature drops below 0 °C foods may freeze.

- ▶ Do not store cold-sensitive produce such as cucumbers, aubergines, courgettes and tropical fruit in the full-space BioFresh appliance.

For optimal storage of foods, you can regulate the humidity in the appliance using the HumidityPlus function. (see HumidityPlus)

HumidityPlus function	Storage climate	Food
activated	more humid storage climate	loose fruit and vegetables with a high moisture content
deactivated (default setting)	drier storage climate	dry or packaged foods (e.g. dairy products, meat, fish, sausages)

6.2.1 Arranging your food properly

When HumidityPlus is activated:

- Store unpackaged fruit and vegetables.

When HumidityPlus is deactivated:

- Store dry or packaged foods (e.g. dairy products, meat, fish, sausages).

6.3 Storage times

Refer to the specified storage times as a guide.

In the case of foods with a minimum shelf life, the date indicated on the packaging still applies.

6.3.1 BioFresh

Recommended storage periods with HumidityPlus deactivated		
Butter	at 1 °C	up to 90 days
Hard cheese	at 1 °C	up to 110 days
Milk	at 1 °C	up to 12 days
Sausage, cold meats	at 1 °C	up to 8 days
Poultry	at 1 °C	up to 6 days
Pork	at 1 °C	up to 6 days
Beef	at 1 °C	up to 6 days
Game	at 1 °C	up to 6 days

Note

- Remember that high-protein foods perish quicker; shellfish and crustaceans do not last as long as fish, and fish does not last as long as meat.

Recommended storage periods with HumidityPlus activated		
Vegetables, salads		
Artichokes	at 1 °C	up to 14 days
Celery	at 1 °C	up to 28 days
Cauliflower	at 1 °C	up to 21 days
Broccoli	at 1 °C	up to 13 days
Chicory	at 1 °C	up to 27 days
Lettuce	at 1 °C	up to 19 days
Peas	at 1 °C	up to 14 days
Kale	at 1 °C	up to 14 days
Carrots	at 1 °C	up to 80 days
Garlic	at 1 °C	up to 160 days
Turnip	at 1 °C	up to 14 days

Recommended storage periods with HumidityPlus activated		
Lettuce	at 1 °C	up to 13 days
Herbs	at 1 °C	up to 13 days
Leeks	at 1 °C	up to 29 days
Mushrooms	at 1 °C	up to 7 days
Radishes	at 1 °C	up to 10 days
Brussels sprouts	at 1 °C	up to 20 days
Asparagus	at 1 °C	up to 18 days
Spinach	at 1 °C	up to 13 days
Savoy	at 1 °C	up to 20 days
Fruit		
Apricots	at 1 °C	up to 13 days
Apples	at 1 °C	up to 80 days
Pears	at 1 °C	up to 55 days
Blackberries	at 1 °C	up to 3 days
Dates	at 1 °C	up to 180 days
Strawberries	at 1 °C	up to 7 days
Figs	at 1 °C	up to 7 days
Blueberries	at 1 °C	up to 9 days
Raspberries	at 1 °C	up to 3 days
Currants	at 1 °C	up to 7 days
Sweet cherries	at 1 °C	up to 14 days
Kiwis	at 1 °C	up to 80 days
Peaches	at 1 °C	up to 13 days
Plums	at 1 °C	up to 20 days
Cranberries	at 1 °C	up to 60 days
Rhubarb	at 1 °C	up to 13 days
Gooseberries	at 1 °C	up to 13 days
Grapes	at 1 °C	up to 29 days

7 Saving energy

- Pay attention to good ventilation. Do not cover ventilation holes or grids.
- Always keep the fan air slits clear.
- Do not place the appliance in direct sunlight or near radiators or similar sources of heat.
- If the appliance is placed directly next to an oven, the energy consumption may increase slightly. This is dependent on the service life and usage intensity of the oven.
- Energy consumption depends on the installation conditions, e.g. the ambient temperature. A warmer ambient temperature can increase the energy consumption.
- Open the appliance for as short a time as possible.
- The lower the temperature is set the higher the energy consumption.
- Keep all food properly packed and covered. This prevents frost from forming.
- Only take food out for as long as necessary so that it doesn't warm up too much.
- Inserting warm food: allow to cool down to room temperature first.

8 Controls

8.1 Controls and displays

8.1.1 Status display

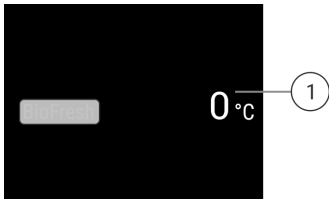

Fig. 29 The status display shows the actual temperature.

(1) Temperature display

The status display shows the actual temperature and is the initial display. Navigation to the functions takes place from there.

8.1.2 Display symbols

Display symbols provide information on the current appliance status:

Symbol	Appliance status
	Standby The appliance or temperature zone is switched off.
	Flashing number Appliance is working. Temperature flashes until the set temperature is reached.
	Flashing symbol Appliance is working. Setting is made.

8.2 Appliance functions

8.2.1 Notes on the appliance functions

The appliance functions are set at the factory so that your appliance is fully functional.

Before you alter, activate or deactivate the device functions, make sure that the following requirements are met:

- You have read and understood the descriptions of how the display works. (see 4 Functionality of the Touch & Swipe display)
- You have familiarised yourself with the operating and display elements of your appliance.



Switching the appliance off and on

Use this function to switch the entire appliance off and on.

Switching off the appliance

When you switch the appliance off, then the previously saved settings are saved.

Make sure that the following requirements are fulfilled:

- Handling instructions (see 12 Shutting down) are carried out.



Fig. 30

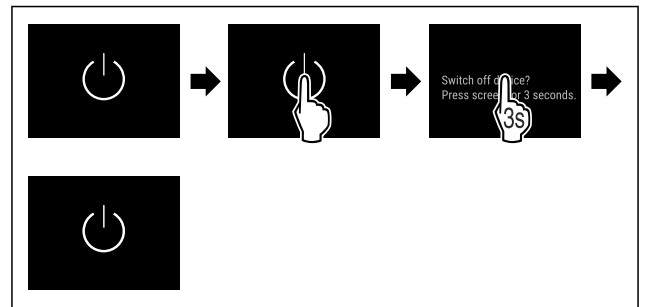

Fig. 31

- ▶ Carry out action steps according to the illustration.
- ▶ Appliance is switched off.
- ▶ The standby symbol appears in the display.
- ▶ Display turns black.

Switching on the appliance

If the display is in sleep mode:

- ▶ Briefly touch the display.

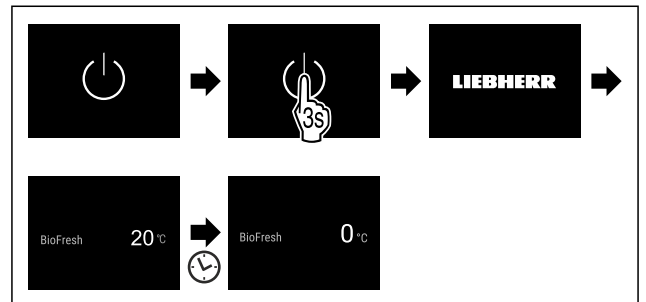

Fig. 32 Example illustration

- ▶ Carry out action steps according to the illustration. When the appliance starts in demo mode:
- ▶ Deactivating demo mode. (see Deactivating demo mode)
- ▶ The appliance is switched on.
- ▶ Previous settings are restored.
- ▶ The appliance cools to the target temperature set.

0 °C Temperature

The temperature depends on the following factors:

- Frequency of door opening
- Duration of door opening
- Room temperature of the installation site
- Type, temperature and quantity of food

BioFresh	Factory-set temperature	Recommended setting
	0 °C	B-Value (see BioFresh B-Value)

Setting the temperature

Set the temperature using the **BioFresh B-Value**. (see BioFresh B-Value)

B5 BioFresh B-Value

Use this function to set the BioFresh B-Value. With the BioFresh B-Value, you can set BioFresh slightly warmer or colder if necessary due to higher or lower ambient temperatures. The BioFresh B-Value is pre-set to value B5 as delivered. If you change the B-Value, refer to the following table:

Value	Description
B1	Lowest temperature
B1-B4	The temperature can drop below 0 °C which means foods can easily freeze.*
B5	Pre-set temperature
B9	Highest temperature

Setting the BioFresh B-Value



Fig. 33

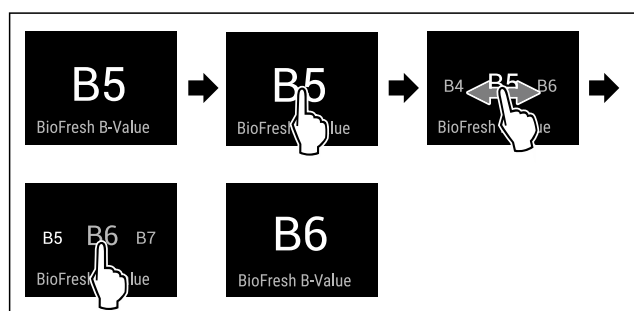

Fig. 34 Example illustration: Switch from B5 to B6.

- ▶ Carry out action steps according to the illustration.
- ▶ The BioFresh B-Value is set.
- ▶ Status display shows target temperature.

SabbathMode

You can use this function to activate or deactivate SabbathMode. If you activate this function, some electronic functions are switched off. As a result, your device meets the religious requirements for Jewish holidays such as Sabbath and complies with STAR-K Kosher certification.

Device status when SabbathMode is active
The status display shows SabbathMode permanently.
All functions on the display are locked except for the Deactivate SabbathMode function.
Active functions remain active.
The display remains bright when you close the door.
The interior lighting is deactivated.
Reminders are not implemented. The set time interval stops.
Reminders and warnings are not displayed.
There is no door alarm.
There is no temperature alarm.
The defrosting cycle operates only for the specified time, without considering the appliance consumption.

Device status when SabbathMode is active
After a power failure, the appliance returns to SabbathMode.

Device status

Note

This appliance has certification from the "Institute for Science and Halacha". (www.machonhalacha.co.il)

You can find a list of STAR-K-certified appliances at www.star-k.org/appliances.

Activating SabbathMode



WARNING

Danger of food poisoning from spoiled food!

If you have SabbathMode activated and a power failure occurs, no message appears in the status display about the power failure. Once the power is restored, the appliance continues to operate in SabbathMode. The power failure may mean that food spoils and the consumption of this food could lead to food poisoning.

After a power failure:

- ▶ Do not consume food that was frozen and has thawed out.



Fig. 35



Fig. 36

- ▶ Carry out action steps according to the illustration.
- ▶ SabbathMode is activated.
- ▶ The status display shows SabbathMode permanently.

Deactivating SabbathMode

The SabbathMode is automatically deactivated after 80 hours. However, you can also deactivate SabbathMode manually at any time:

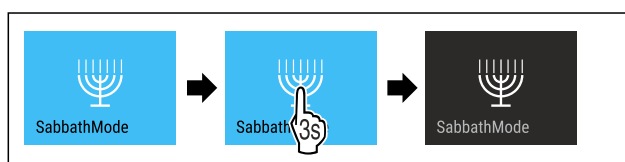

Fig. 37

- ▶ Carry out action steps according to the illustration.
- ▶ SabbathMode is deactivated.



HumidityPlus

You can use this function to activate or deactivate HumidityPlus. If you activate HumidityPlus, the humidity in the device increases and it creates a humid air-conditioning package.

Controls

Humidity-Plus function	Storage climate	Application
Activated	More humid storage climate	Storage of unpackaged salad, vegetables and fruit with high intrinsic moisture (see 6.2 BioFresh)
Deactivated (pre-setting)	Drier storage climate	Storage of dry or packaged food (such as dairy products, meat, fish, sausage) (see 6.2 BioFresh)

Activating HumidityPlus

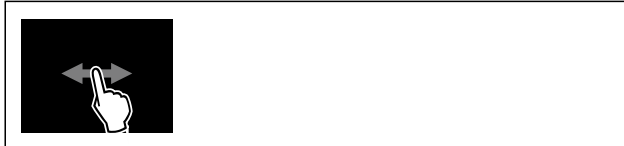

Fig. 38



Fig. 39

- ▶ Carry out action steps according to the illustration.
- ▷ HumidityPlus is activated.

Deactivating HumidityPlus



Fig. 40

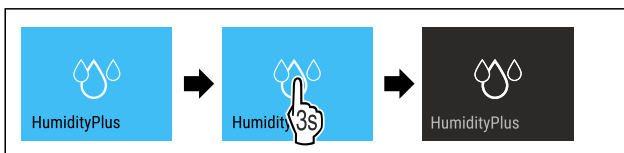

Fig. 41

- ▶ Carry out action steps according to the illustration.
- ▷ HumidityPlus is deactivated.

CleaningMode

You can use this function to activate or deactivate CleaningMode. CleaningMode enables the appliance to be cleaned conveniently.

This setting applies to the fridge section.

Application:

- Clean the fridge section. (see 10.3 Cleaning the appliance)

Device status when CleaningMode is active
The status display shows CleaningMode permanently.
The fridge section is switched off.
Interior lighting is activated.

Device status when CleaningMode is active
The reminders and warnings are not displayed. No signal tone sounds.

Device status

Activating CleaningMode

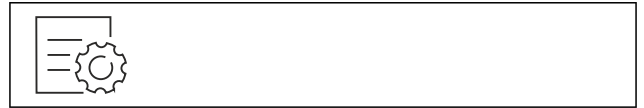

Fig. 42

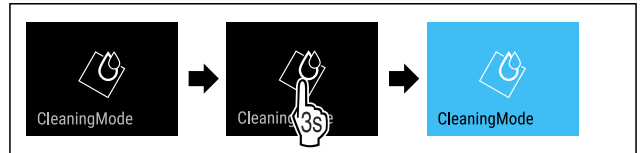

Fig. 43

- ▶ Carry out action steps according to the illustration.
- ▷ CleaningMode is activated.
- ▷ The status display shows CleaningMode permanently.

Deactivating CleaningMode

CleaningMode is deactivated automatically after 60 minutes. However, you can also deactivate CleaningMode manually at any time:

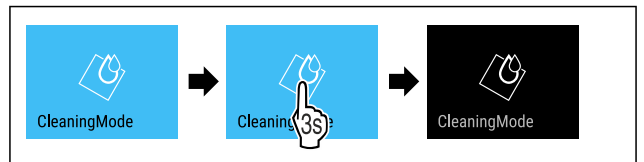

Fig. 44

- ▶ Carry out action steps according to the illustration.
- ▷ CleaningMode is deactivated.
- ▷ The appliance cools to the temperature set previously.

Input lock

You can use this function to activate or deactivate the input lock. The input lock prevents the appliance being operated accidentally, e.g. by children.

Application:

- Avoid unintentional modification of functions.
- Avoid unintentional switching off of the device.
- Avoid unintentional temperature setting.

Activating the input lock

If you activate the input lock, you can continue to navigate in the menus but you cannot select or change other functions.



Fig. 45

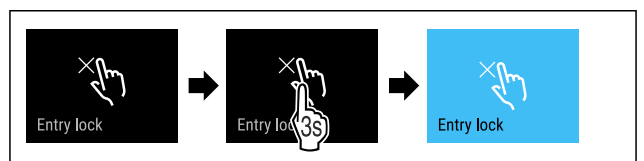

Fig. 46

- ▶ Carry out action steps according to the illustration.

▶ Input lock is activated.

Deactivating the input lock



Fig. 47

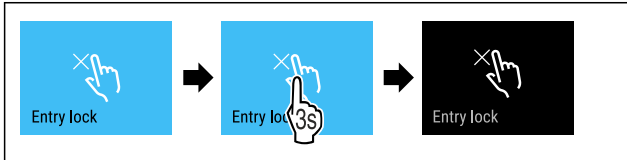

Fig. 48

- ▶ Carry out action steps according to the illustration.
- ▶ Input lock is deactivated.

Language

Use this function to set the display language.

You can select the following languages:

- Deutsch
- English
- Français
- Español
- Italiano
- Nederlands
- Čeština
- Polski
- Português
- Bulgarian
- Русский
- 温度单位

Setting the language



Fig. 49

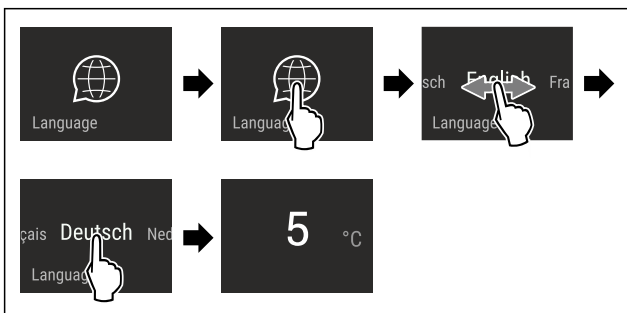

Fig. 50 Example illustration depending on the language and temperature

- ▶ Carry out action steps according to the illustration.
- ▶ The language is set.
- ▶ The display returns to the status display.

Temperature unit

Use this function to set the temperature unit. You can set degrees Celsius or degrees Fahrenheit as the temperature unit.

Setting the temperature unit



Fig. 51

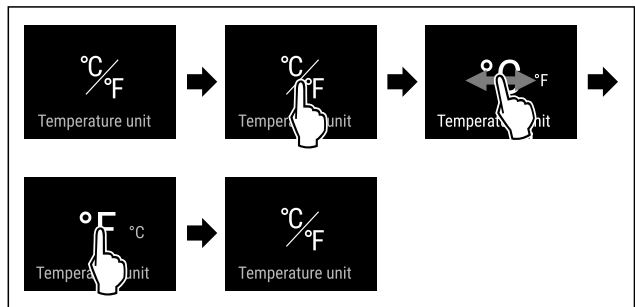

Fig. 53 Example illustration: Switch from degrees Celsius to degrees Fahrenheit.

- ▶ Carry out action steps according to the illustration.
- ▶ The temperature unit is set.

Display brightness

Use this function to set the display brightness in stages.

You can select the following brightness levels:

- 40 %
- 60 %
- 80 %
- 100 % (pre-setting)

Setting the brightness

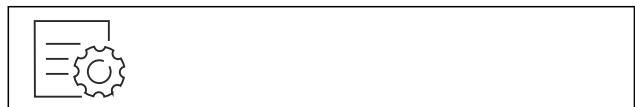

Fig. 54

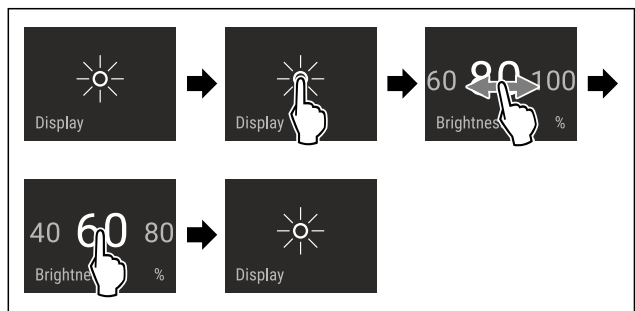

Fig. 55 Example illustration: Switch from 80 % to 60 %.

- ▶ Carry out action steps according to the illustration.
- ▶ The brightness is set.

WiFi

Use this function to connect your appliance to WiFi. You can then operate it via the SmartDevice app on a mobile device. You can also use this function to disconnect or reset the WiFi connection.

More information on the SmartDevice: (see 2.3 SmartDevice)

Note

The SmartDevice function is not available in the following countries: Russia, Belarus, Kazakhstan.

Controls

Establishing the WiFi connection for the first time

Make sure that the following requirements are fulfilled:

- ❑ You have installed the SmartDevice app (see apps.home.liebherr.com).
- ❑ Registration in the SmartDevice app is completed.



Fig. 56

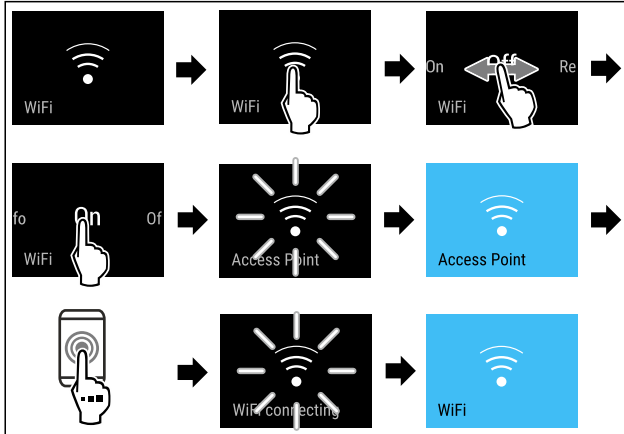

Fig. 57

- ▶ Carry out action steps according to the illustration.
- ▷ Connection is established.

Disconnecting from the WiFi



Fig. 58

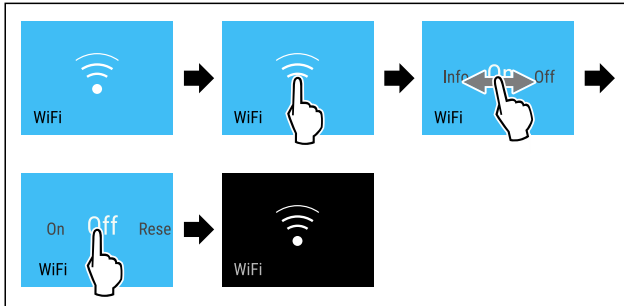

Fig. 59

- ▶ Carry out action steps according to the illustration.
- ▷ There is no connection.

Resetting the WiFi connection



Fig. 60

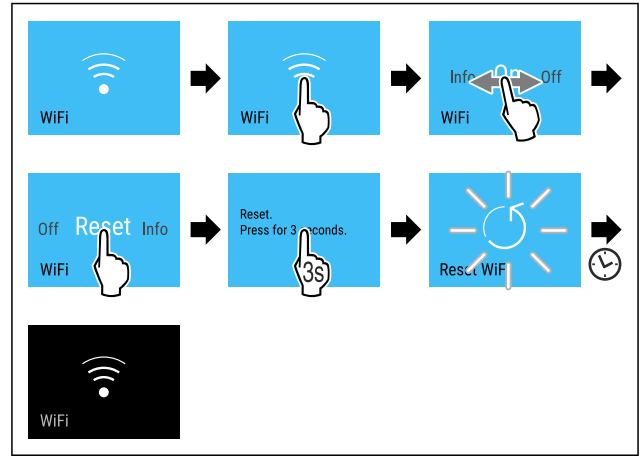

Fig. 61

- ▶ Carry out action steps according to the illustration.
- ▷ WiFi connection and other WiFi settings are reset to factory settings.

Showing information about the WiFi connection



Fig. 62

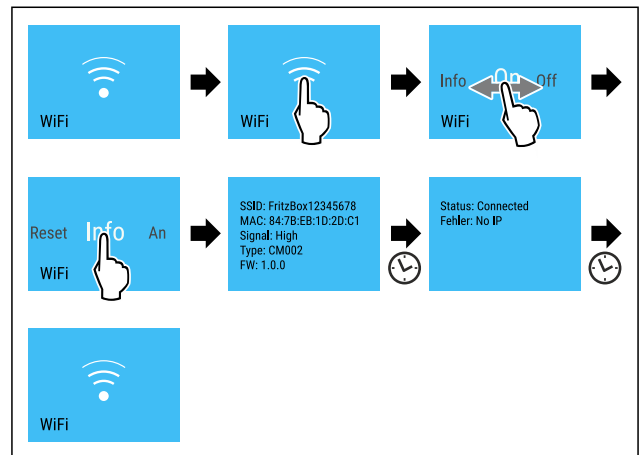

Fig. 63

- ▶ Carry out action steps according to the illustration.



Device information

Use this function to indicate the model name, index, serial number and service number of your device. You will need the device information when you contact customer service. (see 11.4 Customer Service)

This function also opens the Advanced menu. (see 4 Functionality of the Touch & Swipe display)

Indicating the device information

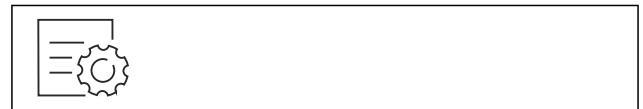

Fig. 64

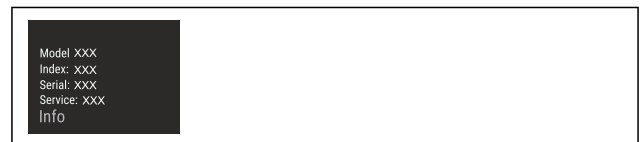

Fig. 65

- ▶ Carry out action steps according to the illustration.
- ▶ Display indicates device information.

Software

Use this function to indicate the software version of your device.

Indicating the software version



Fig. 66



Fig. 67

- ▶ Carry out action steps according to the illustration.
- ▶ Display indicates software version.

Door alarm

Use this function to activate or deactivate the door alarm. The door alarm sounds if the door is open for too long. The door alarm is activated on delivery. You can set how long the door may be open before the door alarm sounds.

The following values can be set:

- 1 minute
- 2 minutes
- 3 minutes
- Off

Setting the door alarm



Fig. 68

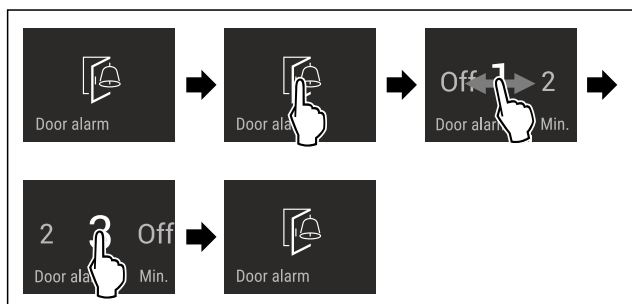

Fig. 69 Example illustration: Change door alarm from 1 minute to 3 minutes.

- ▶ Carry out action steps according to the illustration.
- ▶ The door alarm is set.

Deactivating the door alarm



Fig. 71

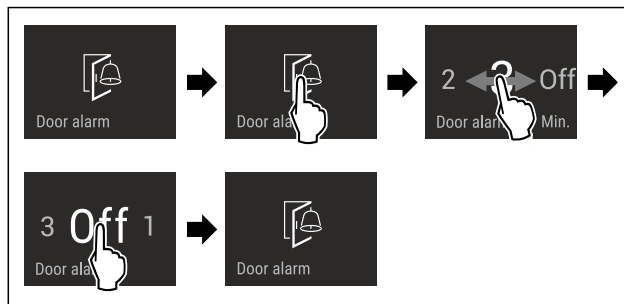

Fig. 72

- ▶ Carry out action steps according to the illustration.
- ▶ The door alarm is deactivated.

Demo mode

Demo mode is a special feature for dealers who want to demonstrate appliance features. If you activate demo mode, all refrigeration functions are deactivated.

If you switch on your appliance and "Demo" appears in the status display, then demo mode is already activated.

If you activate and then deactivate demo mode, the appliance will be reset to factory defaults. (see Resetting to factory settings)

Activating demo mode



Fig. 73

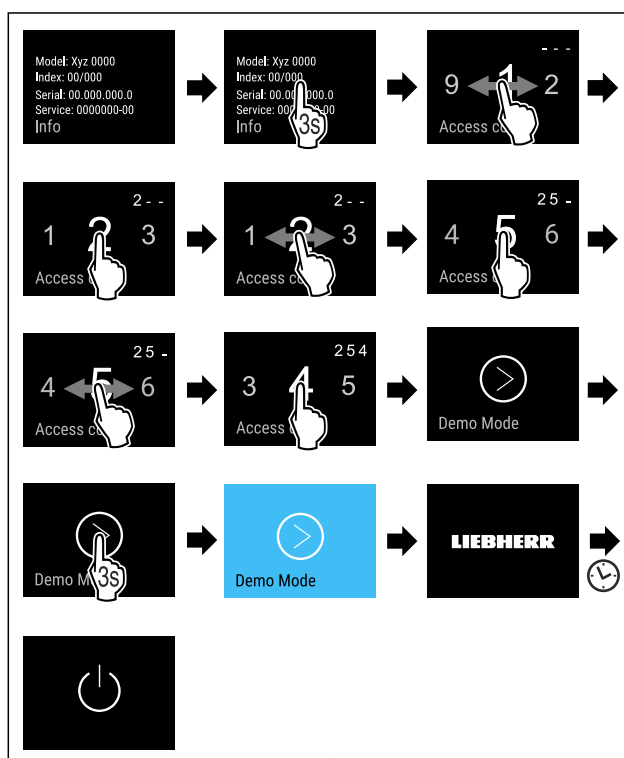

Fig. 74

- ▶ Carry out action steps according to the illustration.
- ▶ Demo mode is activated.
- ▶ Appliance is switched off.
- ▶ Switch on the appliance. (see 5.1 Switching on appliance (first use))
- ▶ "DEMO" appears in the status display.

Controls

Deactivating demo mode



Fig. 75

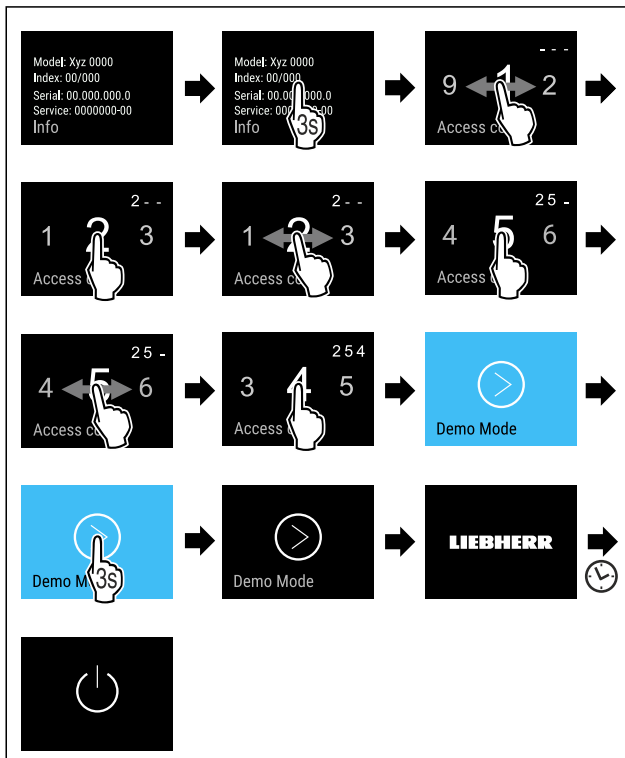

Fig. 76

- ▶ Carry out action steps according to the illustration.
- ▶ Demo mode is deactivated.
- ▶ Appliance is switched off.
- ▶ Switch on the appliance. (see 5.1 Switching on appliance (first use))
- ▶ Appliance is reset to factory settings.



Resetting to factory settings

Use this function to reset all settings to factory defaults. All settings you have made so far are reset to their original settings.

Performing a reset



Fig. 77

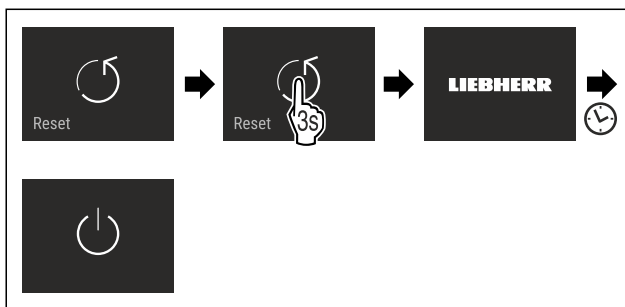

Fig. 78

- ▶ Carry out action steps according to the illustration.

- ▶ Device is reset.
- ▶ Device is switched off.
- ▶ Restart the device. (see 5.1 Switching on appliance (first use))

8.3 Messages

There are two categories of messages:

Category	Importance
Warning	Warnings appear in the event of a door alarm or malfunction. Simple warnings can be cancelled by yourself. In the event of serious malfunctions, you must contact customer service. (see 11.4 Customer Service)
Reminder	Reminders remind you of general processes. You can carry out these operations to end the message.

8.3.1 Overview of warnings

Behaviour of the appliance in the event of warnings:

- Warning appears in red on the display.
- The alarm tone sounds at an ever-increasing volume.
- The interior lighting pulsates for some warnings.

Message	Cause	Exit message	the
 Door alarm	The message appears if the door is open for too long.	Carry out action steps. (see Door alarm)	Door alarm
 Error	The message appears if there is an appliance error. A component of the appliance has a fault.	Carry out action steps. (see Error)	Error
 WLAN error	The message appears if the appliance could not be connected to the WLAN. (see Establishing the WiFi connection for the first time) The message only appears during the initial setup.	Carry out action steps. (see WLAN error)	WLAN error

8.3.2 Ending warnings

Door alarm

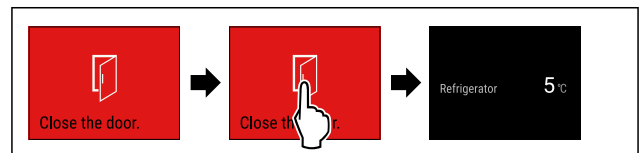

Fig. 79 Example illustration

- ▶ Carry out action steps according to the illustration.
- or-
- ▶ Close the door.

▶ The display returns to the status indicator.

You can set how long the door may be open before the door alarm sounds. (see Setting the door alarm)

Error

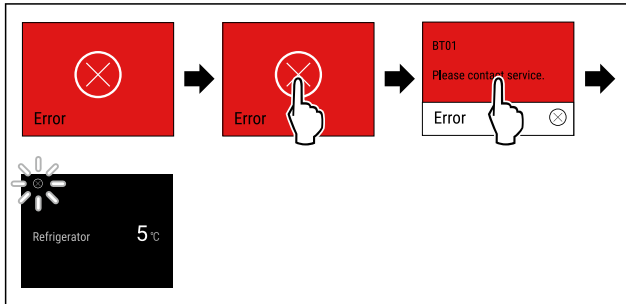

Fig. 80 Example illustration

- ▶ Briefly touch the display.
- ▶ Error code is displayed.
- ▶ Note the error code.
- ▶ Briefly touch the display.
- ▶ The display returns to the status indicator.
- ▶ Contact Customer Service. (see 11.4 Customer Service)

WLAN error

- ▶ Check WLAN connection.
- ▶ Reconnect the appliance to the WLAN. (see WiFi)

8.3.3 Overview of reminders

Behaviour of the appliance during reminders:

- Reminder appears yellow on the display.
- Alarm tone sounds.
- The interior lighting pulsates for some reminders.

The following reminders can be deactivated :

9 Features

9.1 Drawers

You can remove the drawers for cleaning.

The way to remove/insert the drawers varies depending on the pull-out system. Your appliance can contain various pull-out systems.

Note

The energy consumption increases and the cooling power goes down if ventilation is not sufficient.

- ▶ Always keep the inside vents at the rear wall clear.

9.1.1 Drawer on moulded rib

The drawer runs directly on the moulded rib. There are no rails.

Removing drawer

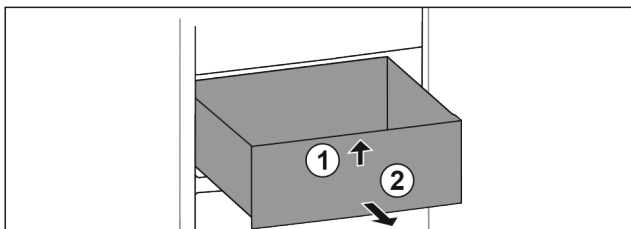

Fig. 81

- ▶ Pull out drawer as far as it will go.
- ▶ Lift up drawer at the front. Fig. 81 (1)
- ▶ Remove drawer to the front. Fig. 81 (2)

Inserting drawer

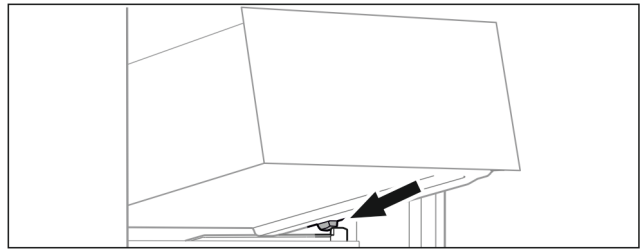

Fig. 82

- ▶ Place drawer at an angle behind the stoppers on the moulded rib. (see Fig. 82)
- ▶ Lower drawer.
- ▶ Slide in drawer to the back.

9.1.2 Bottom drawer

The drawer is the lowest drawer in the appliance. It runs directly on the moulded rib. There are no rails.

Removing drawer

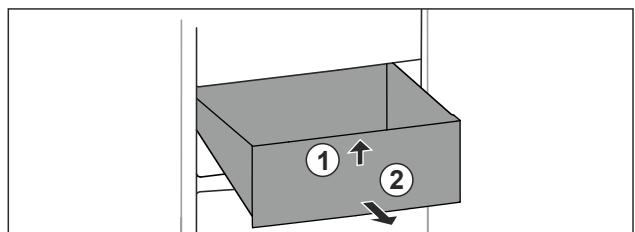

Fig. 83

- ▶ Pull out drawer as far as it will go.
- ▶ Lift up drawer at the front. Fig. 83 (1).
- ▶ Remove drawer to the front. Fig. 83 (2).

Inserting drawer

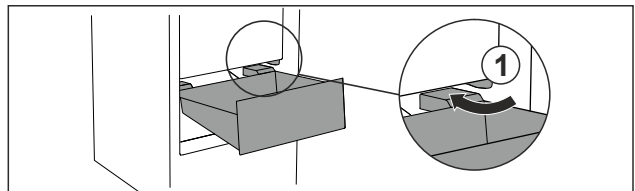

Fig. 84

- ▶ Guide drawer in at an angle around the stoppers Fig. 84 (1).
- ▶ Lower drawer.
- ▶ Slide in drawer to the back.

10 Maintenance

10.1 Disassembling / assembling pull-out systems

10.1.1 Notes on disassembly

You can disassemble some of the pull-out systems for cleaning. Your appliance can contain a variety of pull-out systems.

The following pull-out systems can be disassembled or cannot be disassembled:

Pull-out system	can be disassembled / cannot be disassembled
Drawer guided on container rib	can be disassembled (see 10.1.2 Drawer on moulded rib)

Maintenance

Pull-out system	can be disassembled / cannot be disassembled
Bottom drawer	cannot be disassembled

10.1.2 Drawer on moulded rib

Disassembling pull-out system

Make sure the following prerequisites are met:

- Drawer has been removed. (see 9.1.1 Drawer on moulded rib)

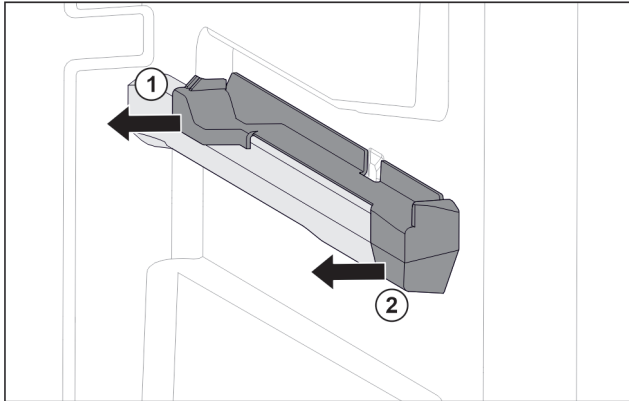

Fig. 85 Attachment on the right moulded rib

- ▶ Grab attachment at the back from below.
- ▶ Pull off attachment at the back sideways. Fig. 85 (1)
- ▶ Pull off attachment at the front sideways. Fig. 85 (2)

Installing pull-out system

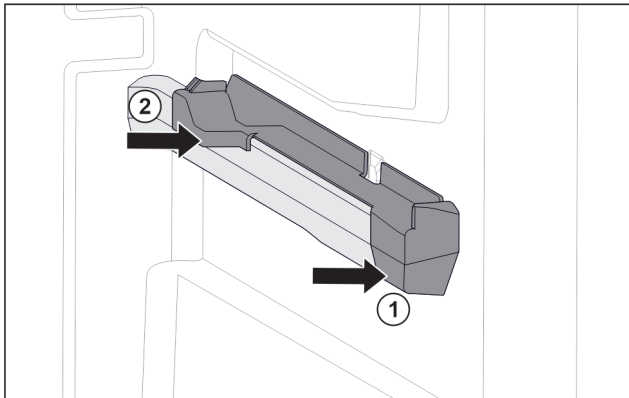

Fig. 86 Attachment on the right moulded rib

- ▶ Position attachment on moulded rib at the front. Fig. 86 (1)
- ▶ Press on attachment at the back. Fig. 86 (2)

10.2 Defrosting the appliance



WARNING

Improper defrosting of the appliance!
Injuries and damage.

- ▶ Do not use mechanical equipment or other methods to speed up the defrosting process other than those recommended by the manufacturer.
- ▶ Do not use electrical heating or steam-cleaning appliances, naked flames or defroster sprays to defrost.
- ▶ Do not use sharp objects to remove ice.

Defrosting is performed automatically. The water from the thawing process drains through the outlet and evaporates.

Water drops or a thin layer of frost or ice can form on the back wall; this is a completely normal part of the appliance's function. This must not be removed.

- ▶ Clean the drain opening at regular intervals. (see 10.3 Cleaning the appliance)

10.3 Cleaning the appliance

10.3.1 Ready



WARNING

Danger of electric shock!

- ▶ Remove the refrigerator connector or interrupt the power supply.



WARNING

Risk of fire

- ▶ Do not damage the refrigeration circuit.

- ▶ Empty the appliance.
- ▶ Remove mains connector.

-or-

- ▶ Activate CleaningMode. (see CleaningMode)

10.3.2 Clean the housing

NOTICE

Improper cleaning!

Damage to the appliance.

- ▶ Only use soft cleaning cloths and ph-neutral all-purpose cleaners.
- ▶ Do not use abrasive sponges or steel wool which may cause scratches.
- ▶ Do not use any sharp or abrasive cleaning agents, nor any that contain sand, chloride or acid.



WARNING

Risk of injury and damage as a result of hot steam!

Hot steam can lead to burns and can damage the surfaces.

- ▶ Do not use any steam cleaners!

- ▶ Wipe the housing down with soft, clean cloth. If very dirty, use lukewarm water with a neutral cleaner. Glass surfaces can also be cleaned with glass cleaner.

10.3.3 Cleaning the interior

NOTICE

Improper cleaning!

Damage to the appliance.

- ▶ Only use soft cleaning cloths and ph-neutral all-purpose cleaners.
- ▶ Do not use abrasive sponges or steel wool which may cause scratches.
- ▶ Do not use any sharp or abrasive cleaning agents, nor any that contain sand, chloride or acid.

- ▶ Plastic surfaces: clean by hand with a soft clean cloth, lukewarm water and a little detergent.
- ▶ Metal surfaces: clean by hand with a soft clean cloth, lukewarm water and a little detergent.

10.3.4 Clean the components

NOTICE

Improper cleaning!

Damage to the appliance.

- ▶ Only use soft cleaning cloths and ph-neutral all-purpose cleaners.
- ▶ Do not use abrasive sponges or steel wool which may cause scratches.
- ▶ Do not use any sharp or abrasive cleaning agents, nor any that contain sand, chloride or acid.

Clean with a soft, clean cloth, lukewarm water and some detergent:

- Drawer
- ▶ To disassemble components: see the relevant section.
- ▶ Clean the components.

10.3.5 After cleaning

- ▶ Wipe the appliance and the components dry.
- ▶ Connect and switch on the appliance.
The temperature is cold enough:
- ▶ Place the food inside.
- ▶ Repeat cleaning regularly.

11 Customer help

11.1 Technical specifications

Temperature range	
BioFresh	B1 to B9

Maximum loading weight for the equipment			
Equipment	Appliance width 600 mm (see installation instructions, device dimensions)	Appliance width 700 mm (see installation instructions, device dimensions)	Appliance width 750 mm (see installation instructions, device dimensions)
Drawer container rib on (see 9.1.1 Drawer on moulded rib)	19 kg	25 kg	--
Bottom drawer (see 9.1.2 Bottom drawer)	11 kg	19 kg	

Lighting	
Class ¹	Light source
This product contains one or more energy efficiency class G light sources.	LED

¹ The appliance may contain light sources with different energy efficiency classes. The lowest energy efficiency class is indicated.

For appliances with a WiFi connection:

Frequency specification	
Frequency band	2.4 GHz

Frequency specification	
Maximum radiated power	< 100 mW
Purpose of the wireless equipment	Integration in the local WiFi network for data communication

11.2 Operating noises

The appliance makes different noises when it is on.

- At **higher temperatures** the appliance uses less energy but works for longer. It is **quieter**.
- At **lower temperatures** the food is cooled faster. It is **louder**.

Examples:

- Functions on (see 8.2 Appliance functions)
- Fan running
- Food recently added
- High ambient temperature
- Door open for a while

Noise	Possible cause	Type of noise
Bubbling and splashing	Coolant flowing into the cooling circuit.	Normal operating noise
Hissing	Coolant sprays into the cooling circuit.	Normal operating noise
Humming	The appliance is cooling. The volume depends on the cooling output.	Normal operating noise
Humming and rustling	The fan is running.	Normal operating noise
Clicking	Components are switched on and off.	Normal switching noise
Rattling humming or	Valves or flaps are working.	Normal switching noise

Noise	Possible cause	Type of noise	Lifting
Vibration	Improper setup	Defective noise	Level the appliance using the adjustable feet.
Rattling	Components, items inside the appliance	Defective noise	Secure components. Leave enough space between the items.

11.3 Technical fault

Your appliance is designed and built to ensure it works reliably and has a long service life. In the unlikely event that a fault occurs during operation, please check whether it is due to an operating error. If so, you will be charged for the callout and repair costs even if it falls within the warranty period.

Customer help

You can fix the following faults yourself.

11.3.1 Appliance function

Defect	Cause	Remedy
The appliance is not working.	→ The appliance is not switched on.	▶ Switch the appliance on.
	→ The power plug is not properly plugged into the socket.	▶ Check the power plug.
	→ There is something wrong with the power outlet fuse.	▶ Check the fuse.
	→ Power cut	▶ Keep the appliance closed.
	→ The IEC socket is not plugged into the appliance correctly.	▶ Check the IEC socket.
Temperature is not cold enough.	→ The appliance door is not closed properly.	▶ Close the appliance door.
	→ The ambient temperature is too high.	▶ Problem solution:
	→ The appliance was opened too many times or for too long.	▶ Wait to see if the required temperature corrects itself. If not, contact Customer Service. (see 11.4 Customer Service)
	→ The temperature is set incorrectly.	▶ Turn down the temperature and check after 24 hours.
	→ The appliance is too close to a heat source (oven, radiator, etc).	▶ Move the appliance or the heat source.
The door seal is defective or needs to be replaced for another reason.	→ The door seal can be replaced. It can be replaced without the need for special tools.	▶ Contact Customer Service. (see 11.4 Customer Service)
The appliance builds up too much ice or condensation.	→ The door seal may have slipped out of its groove.	▶ Check that the door seal is well fitted in the groove.
The exterior surfaces of the appliance are warm.*	→ The heat of the refrigeration circuit is used to avoid condensation.	▶ This is normal.

11.3.2 Features

Defect	Cause	Remedy
The internal light does not come on.	→ The appliance is not switched on.	▶ Switch the appliance on.
	→ The door was open for longer than 15 minutes.	▶ Interior lighting switches off automatically after about 15 minutes when the door is open.
	→ The LED interior light is faulty or the lid is damaged.	▶ Contact Customer Service. (see 11.4 Customer Service)

11.4 Customer Service

First check whether you can rectify the fault yourself (see 11 Customer help) . If you cannot rectify the problem, contact Customer Service.

You can find the address in the enclosed brochure "Liebherr-Service" or at home.liebherr.com/service.



WARNING

Unprofessional repair!
Injuries.

- ▶ Have any repairs and action - not expressly specified - on the appliance and mains cable carried out by service personnel only. (see 10 Maintenance)
- ▶ A damaged mains cable may only be replaced by the manufacturer, the manufacturer's Customer Service or a similarly qualified person.
- ▶ In the case of appliances with an IEC connector, the change may be made by the customer.

11.4.1 Contacting Customer Service

Make sure that the following appliance information is available:

- Appliance name (model and index)
- Service no. (Service)
- Serial no. (S no.)
- ▶ Call up the appliance information via the display. (see Device information)
- or-
- ▶ Refer to the type plate for appliance information. (see 11.5 Model plate)
- ▶ Note down the appliance information.
- ▶ Notify customer service: Report errors and the appliance information.
- ▶ This will help us to provide you with a faster, more accurate service.
- ▶ Follow further instructions from Customer Service.

11.5 Model plate

The model plate is behind the drawers on the inside of the appliance.

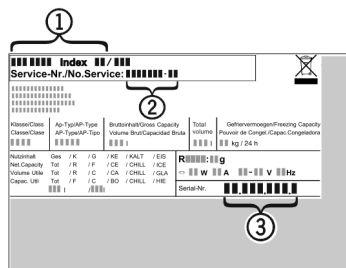

Fig. 87

- (1) Appliance description (3) Serial no.
(2) Service no.

- ▶ Note the data on the model plate.

12 Shutting down

- ▶ Empty the appliance.
- ▶ Switch off appliance. (see Switching the appliance off and on)
- ▶ Pull the mains plug out of the socket.
- ▶ Remove the IEC socket if required: Pull the IEC socket out of the appliance plug and move it to the left and right at the same time.
- ▶ Clean appliance. (see 10.3 Cleaning the appliance)
- ▶ Leave the door open, so that no unpleasant odours arise.

13 Disposal

Ensure that the following requirements are met:

- Meaning of the symbols on the appliance: are familiar. (see 1.14 Symbols on the appliance)
- Notes on disposal are familiar. (see 1.8 Disposal)

13.1 Preparing the appliance for disposal

- ▶ Shutting your appliance down. (see 12 Shutting down)

13.2 Disposing of the appliance in an environmentally friendly manner



WARNING

Leaking coolant and oil!

Fire. The coolant contained in the appliance is eco-friendly, but also flammable. The oil contained in the appliance is flammable. Escaping coolant and oil can ignite if the concentration is high enough and in contact with an external heat source.

- ▶ Do not damage the pipelines of the coolant circuit and the compressor.
- ▶ Observe the notes on transporting the appliance. (see 3.6 Transporting the appliance)
- ▶ Remove the appliance without damaging it.
- ▶ Dispose of appliance according to specifications.

Scan QR Code and find
digital operating and
installation instructions.

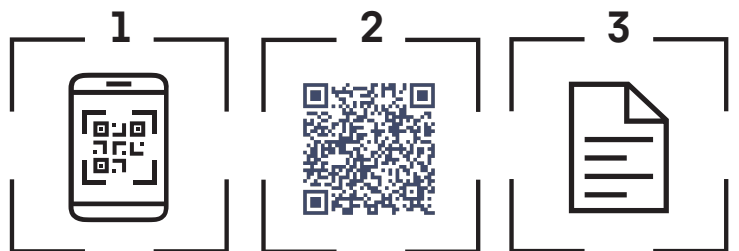

home.liebherr.com

20251209

7088650-00

Liebherr-Hausgeräte GmbH
Memminger Straße 77-79
88416 Ochsenhausen
Deutschland