

# Operating and installation instructions



[home.liebherr.com/  
fridge-manuals](https://home.liebherr.com/fridge-manuals)





LIEBHERR













EN

ORIGINAL OPERATOR'S MANUAL

**LIEBHERR**

# Contents





<b>1</b>	<b>Safety information and warnings.....</b>	<b>3</b>
1.1	Intended use.....	3
1.2	Climate classes.....	3
1.3	User group.....	3
1.4	Installation and commissioning.....	3
1.5	Safe handling of the appliance.....	3
1.6	Cleaning.....	4
1.7	Faults, damage and repairs.....	4
1.8	Disposal.....	4
1.9	Conformity.....	4
1.10	SVHC substances in accordance with the REACH Regulation.....	4
1.11	EPREL database.....	4
1.12	Open source licences.....	4
1.13	Spare parts.....	4
1.14	Symbols on the appliance.....	4
1.15	Warning levels.....	5
<b>2</b>	<b>Appliance at a glance.....</b>	<b>5</b>
2.1	Scope of delivery.....	5
2.2	Overview of the appliance and equipment.....	5
2.3	SmartDevice.....	5
<b>3</b>	<b>Setting up and connecting.....</b>	<b>6</b>
3.1	Installation requirements.....	6
3.2	Appliance dimensions.....	6
3.3	Ventilation requirements.....	7
3.4	Connection dimensions for the power supply.....	7
3.5	Transporting the appliance.....	7
3.6	Unpacking the appliance.....	8
3.7	Explanation of symbols used.....	8
3.8	Door hinge change.....	9
3.9	Mounting wall spacers*.....	14
3.10	Setting up the appliance.....	14
3.11	Setting up the appliance so that it is level.....	14
3.12	After setting up.....	15
3.13	Installing multiple appliances.....	15
3.14	Integrating the appliance into a kitchen unit.....	15
3.15	Disposing of packaging.....	16
3.16	Connecting the appliance to the power supply.....	16
<b>4</b>	<b>Functionality of the Touch display.....</b>	<b>17</b>
4.1	Navigation and symbol explanation.....	17
4.2	Menus.....	17
4.3	Sleep mode.....	18
<b>5</b>	<b>Putting into operation.....</b>	<b>18</b>
5.1	Switching on appliance (first use).....	18
<b>6</b>	<b>Storage.....</b>	<b>18</b>
6.1	Information regarding storage.....	18
6.2	Freezer compartment.....	19
6.3	Storage times.....	19
<b>7</b>	<b>Saving energy.....</b>	<b>19</b>
<b>8</b>	<b>Controls.....</b>	<b>20</b>
8.1	Controls and displays.....	20
8.1.1	Status display.....	20
8.1.2	Display symbols.....	20
8.2	Appliance functions.....	20
8.2.1	Notes on the appliance functions.....	20
	Switching the appliance off and on.....	20
		
	Temperature.....	20
	SuperFrost.....	21
	PartyMode .....	21

	SabbathMode.....	22
	E-Saver .....	22
	Input lock.....	23
	Temperature unit.....	23
	Display brightness.....	23
	WiFi.....	24
	Device information.....	25
	Software.....	25
	Start defrosting cycle.....	25
	Door alarm.....	25
	Demo mode.....	26
	Resetting to factory settings.....	27
8.3	Messages.....	27
8.3.1	Overview of warnings.....	27
8.3.2	Ending warnings.....	27
8.3.3	Overview of reminders.....	28
<b>9</b>	<b>Features.....</b>	<b>28</b>
9.1	Drawers.....	28
9.2	VarioSpace.....	29
<b>10</b>	<b>Maintenance.....</b>	<b>29</b>
10.1	Disassembling / assembling pull-out systems.....	29
10.2	Defrosting the appliance.....	30
10.3	Cleaning the appliance.....	30
<b>11</b>	<b>Customer help.....</b>	<b>30</b>
11.1	Technical specifications.....	30
11.2	Operating noises.....	31
11.3	Technical fault.....	31
11.4	Customer Service.....	32
11.5	Model plate.....	32
<b>12</b>	<b>Shutting down.....</b>	<b>33</b>
<b>13</b>	<b>Disposal.....</b>	<b>33</b>
13.1	Preparing the appliance for disposal.....	33
13.2	Disposing of the appliance in an environmentally friendly manner.....	33

The manufacturer is continually working on the further development of all types and models. Please be aware that we reserve the right to make changes to the shape, equipment and technology.

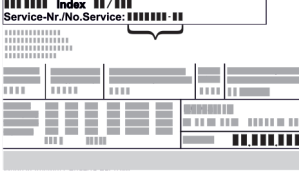
Symbol	Explanation
	<b>Read instructions</b> Please read the information in these instructions carefully to understand all of the benefits of your new appliance.

# Safety information and warnings

Symbol	Explanation
	<p><b>Additional information on the Internet</b></p> <p>The digital manual with additional information and in other languages can be found via the QR code on the front of the manual or by entering the service number at <a href="http://home.liebherr.com/fridge-manuals">home.liebherr.com/fridge-manuals</a>.</p> <p>The service number can be found on the serial tag:</p>  <p style="text-align: center;"><i>Fig. Example illustration</i></p>
	<p><b>Check appliance</b></p> <p>Check all parts for transport damage. If you have any complaints, please contact your agent or customer service.</p>
	<p><b>Differences</b></p> <p>These instructions apply to a range of models, so differences are possible. Sections that apply to certain models only are marked with an asterisk (*).</p>
	<p><b>Instructions and results</b></p> <p>Instructions are marked with a ►.</p> <p>Results are marked with a ▷.</p>
	<p><b>Videos</b></p> <p>Videos about the appliances are available on the YouTube channels of Liebherr-Hausgeräte.</p>

## Open source licences:

The appliance contains software components that use open source licences. Information on the open source licences used can be found here: [home.liebherr.com/open-source-licences](http://home.liebherr.com/open-source-licences)

This user information applies to the following appliances:

SFN..	52..
-------	------

## Note

If your appliance has an N in its appliance designation, it is a NoFrost appliance.

# 1 Safety information and warnings

Keep this user information in a safe place so that you can refer to it at any time.

If you pass on the appliance, pass this user information on to subsequent owners.

To use the appliance properly and safely, read this user information carefully before installation and use. Always follow the instructions, safety instructions and warnings contained therein. They are important so that you can install and operate the appliance safely and properly.

## 1.1 Intended use

- This appliance is intended for household use and similar applications such as:

- in staff kitchen areas in shops, offices and other work areas
- in agricultural environments and by guests in hotels, motels and other accommodation
- in bed and breakfasts
- in catering and similar wholesale operations
- Further uses:
  - All other types of application are impermissible.

## 1.2 Climate classes

Depending on its climate class, the appliance is designed for operation within certain ambient temperature limits. The climate class for your appliance is printed on the type plate.

### Note

- In order to guarantee fault-free operation comply with the specified ambient temperatures.

Climate class	for ambient temperatures from
SN	10 °C to 32 °C
N	16 °C to 32 °C
ST	16 °C to 38 °C
T	16 °C to 43 °C
SN-ST	10 °C to 38 °C
SN-T	10 °C to 43 °C

If your appliance does not have a fixed water connection, the appliance is guaranteed to function properly down to a lower ambient temperature of -15 °C.

## 1.3 User group

- This appliance can be used by children aged from 8 years and above and persons with reduced physical, sensory or mental capabilities or lack of experience and knowledge if they have been given supervision or instruction concerning use of the appliance in a safe way and understand the hazards involved.
- Children must not play with the appliance.
- Children must not carry out cleaning and user maintenance without supervision.
- Children aged from 3 to 8 years are allowed to load and unload refrigerating appliances.

## 1.4 Installation and commissioning

- Only set up and connect the appliance in accordance with the instructions in the user information.
- Do not close the ventilation openings in the appliance housing or in the installation housing.
- Do not damage the mains cable. The appliance must not be operated with a defective mains cable.
- Do not place portable multiple sockets or power supply units at the rear of the appliance.
- It must be easy to access the socket so that the appliance can be quickly disconnected from the power supply in case of an emergency. It must not be behind the appliance.

## 1.5 Safe handling of the appliance

- Do not store any explosive substances, such as aerosol containers with flammable propellant gas, in the appliance. These types of aerosol can be identified by the list of contents printed on it, or by a flame symbol. Any leaking gas may ignite due to electrical parts.

# Safety information and warnings

- Keep burning candles, lamps and other objects with naked flames away from the appliance, so that these do not set fire to the appliance.
- Alcoholic beverages and other containers bearing alcohol must be sealed tight for storage. Any leaking alcohol may ignite due to electrical parts.
- Avoid prolonged skin contact with cold surfaces or with cold/frozen food. Use gloves for protection, for example.
- The refrigerant contained (information on the type plate) is environmentally friendly but flammable. Leaking refrigerant may ignite.
  - Do not damage the refrigeration circuit.
  - Do not use any ignition sources inside the appliance.
  - Do not use electrical appliances inside the appliance (e.g. steam cleaners, heaters).
  - If the refrigerant leaks: remove any naked flames or ignition sources from the vicinity of the leakage point. Properly air the room. Inform customer service.
- Only open the door for a short time. This prevents the temperature inside the appliance from rising.
- Do not reach between the door and the appliance when opening and closing. Fingers may become trapped.
- The temperature in the warmest part of the appliance may be higher than the set temperature.

## 1.6 Cleaning

- Regularly clean surfaces that come into contact with food.
- Do not use an electric heater or steam cleaner, naked flames or defrost spray to speed up the defrosting process.
- Do not remove the ice with sharp objects.

## 1.7 Faults, damage and repairs

- If the mains connection cable of the appliance is damaged, replace the mains connection cable.
- Repairs and interventions on the appliance may only be carried out by the customer service or by other qualified personnel trained for this purpose.
- In the event of malfunctions and appliance faults, pull out the mains plug or switch off the fuse. Always hold the plug when pulling out the mains plug. Never tug on the cable.

## 1.8 Disposal

- The appliance contains valuable materials and is marked with the appropriate symbol. (see 1.14 Symbols on the appliance)
  - Do not dispose of the appliance in the household waste.
  - Dispose of the appliance free of charge at your local recycling centre using the Class 1 collection containers.
  - When purchasing a new appliance, return the old appliance to the retailer free of charge.
  - Provide information about return options.
- Your appliance may contain personal data.
  - Delete personal data before disposal.
- The appliance contains refrigerant (information on the type plate) and oil. The refrigerant inside the appliance is environmentally friendly, but flammable. The oil it contains is also flammable. Escaping refrigerant and oil can ignite in high concentrations and in contact with an external heat source.
  - Do not damage the refrigeration circuit.
  - Only dispose of the appliance in accordance with the instructions in the user information.

## 1.9 Conformity

The coolant circuit has been tested for leak-tightness. The appliance complies with the relevant safety regulations and directives.

The full text of the EU Declaration of Conformity is available at the following web address: [www.liebherr.com](http://www.liebherr.com)

## 1.10 SVHC substances in accordance with the REACH Regulation

- You can use the following link to check whether your appliance contains SVHC substances in accordance with the REACH Regulation:  
[home.liebherr.com/en/en/liebherr-experience/sustainability/environment/scip/scip.html](http://home.liebherr.com/en/en/liebherr-experience/sustainability/environment/scip/scip.html)

## 1.11 EPREL database

- From 1 March 2021, the information on energy labelling and eco-design requirements will be available in the European product database (EPREL). The product database can be accessed via the following link <https://eprel.ec.europa.eu/>. Here, you are asked to enter the model identifier. You will find the model identifier on the type plate.



## 1.12 Open source licences

- The appliance contains software components that use open source licences. Information on the open source licences used can be found here:  
[home.liebherr.com/open-source-licences](http://home.liebherr.com/open-source-licences)



## 1.13 Spare parts

- The spare parts availability for functional parts and stockable parts of the equipment is 15 years.

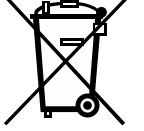
## 1.14 Symbols on the appliance

	This symbol may be found on the compressor. It pertains to the oil in the compressor and indicates the following danger: Can be fatal if swallowed or with penetration of the respiratory tract. This information is only significant for recycling. No risk exists with normal use. Do not remove this symbol.
	Warning: Fire hazard due to flammable substances. This symbol is located on the compressor and can also be found in other places on the appliance. This symbol warns of flammable substances. Do not remove this symbol.
	This or a similar symbol may be on the rear of the appliance. It indicates that there are vacuum insulation panels (VIP) or perlite panels in the door and/or housing. This information is only significant for recycling. Do not remove this symbol.
	This symbol is located on the type plate. It indicates that the appliance contains valuable materials and that you must not dispose of it with household waste. (see 1.8 Disposal)

## 1.15 Warning levels

 <b>DANGER</b>	Identifies an immediately dangerous situation that will result in death or serious bodily injuries if it is not prevented.
 <b>WARNING</b>	Identifies a dangerous situation that could result in death or serious bodily injury if it is not prevented.
 <b>CAUTION</b>	Identifies an immediately dangerous situation that could result in slight or moderate injuries if it is not prevented.
<b>ATTENTION</b>	Identifies a hazardous situation that could result in property damage if it is not prevented.
<b>Note</b>	Identifies useful information and tips.

## 2 Appliance at a glance

### 2.1 Scope of delivery

Check all parts for transport damage. Contact your dealer or customer service in the event of complaints. (see 11.4 Customer Service)

Your new appliance comes with the following parts:

- Standalone appliance
- Features (depending on the model)
- Installation materials (depending on the model)
- "Quick Start Guide"
- "Installation Guide"\*
- Service Brochure

### 2.2 Overview of the appliance and equipment

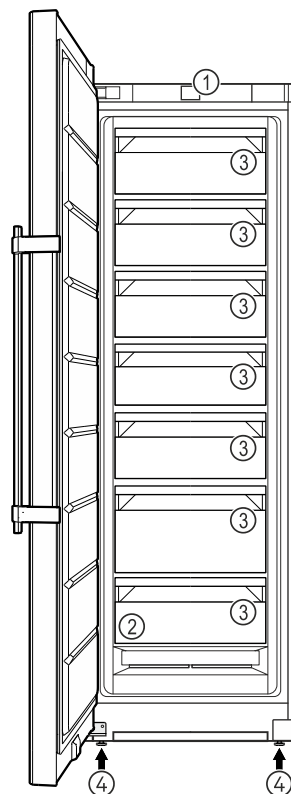

Fig. 1 Example illustration

- (1) Controls
- (2) Type plate
- (3) Drawer
- (4) Adjustable foot

### 2.3 SmartDevice

SmartDevice is the networking solution for your freezer.

If your appliance SmartDevice-enabled or compatible, you can quickly and easily connect your appliance to your WiFi. With the SmartDevice app, you can operate your appliance from a mobile device. Additional functions and setting options are available in the SmartDevice SmartDevice app.

SmartDevice-compatible appliance: Your appliance is compatible for use with the SmartDeviceBox. You must first purchase and install the SmartDeviceBox. In order to connect your appliance to the WiFi, you need to download the SmartDevice app.

More information about SmartDevice: [smartdevice.liebherr.com](http://smartdevice.liebherr.com)

Purchasing the SmartDeviceBox in the Liebherr-Hausgeräte store: [home.liebherr.com/shop/de/deu/smartdevicebox.html](http://home.liebherr.com/shop/de/deu/smartdevicebox.html)

# Setting up and connecting

Downloading the SmartDevice app:



After installing and configuring the SmartDevice app, you can connect your appliance to your Wi-Fi (see WiFi) using the SmartDevice app and the appliance's Wi-Fi function.

## Note

The SmartDevice function is not available in the following countries: Russia, Belarus, Kazakhstan.

You cannot use the SmartDeviceBox.

## 3 Setting up and connecting

### 3.1 Installation requirements

The installation conditions are crucial to ensure that you can operate your appliance safely, efficiently and without problems.

- Observe all safety instructions.
- Consider the location and position in the room.



#### WARNING

Danger of fire due to incorrect positioning!

If the mains cable or plug touches the back of the appliance, the vibration can damage the mains cable or the plug resulting in a short circuit.

- ▶ Make sure the mains cable is not trapped under the appliance when you position the appliance.
- ▶ Stand the appliance so that it is not touched by connectors or main cables.
- ▶ Do not connect any appliances to sockets in the area of the back of the appliance.
- ▶ Do **not** place and operate multi-sockets/power distributors and other electronic devices (such as halogen transformers) at the back of the appliances.



#### WARNING

Fire hazard due to dampness!

If live parts or the mains lead become damp this may cause short circuits.

- ▶ The appliance is designed for use in enclosed areas. Do not operate the appliance outdoors or in areas where it is exposed to splash water or damp conditions.



#### WARNING

Leaking coolant and oil!

Fire. The coolant contained in the appliance is eco-friendly, but also flammable. The oil contained in the appliance is flammable. Escaping coolant and oil can ignite if the concentration is high enough and in contact with an external heat source.

- ▶ Do not damage the pipelines of the coolant circuit and the compressor.

#### 3.1.1 Installation site

- Only set up and use the appliance in enclosed spaces.

- A dry and well-ventilated room is an optimum installation location.
- If the appliance is installed in a very damp environment, condensation may form on the appliance exterior. Always make sure there is good ventilation and aeration at the installation site.
- The more refrigerant there is in the appliance, the larger the room must be in which it is located. In rooms that are too small, a leak can produce a flammable gas/air mixture. For every 8 g of refrigerant, the installation room must be at least 1 m<sup>3</sup> in size. Information on the refrigerant contained is given on the type plate inside the appliance.
- The floor on which the appliance stands must be horizontal and level.

#### 3.1.2 Position in space

- Do not place the appliance in direct sunlight or near radiators or similar sources of heat.
- You can place the appliance directly next to an oven.
- If the appliance is placed directly next to an oven, the energy consumption may increase slightly. This is dependent on the service life and usage intensity of the oven.
- Always position the appliance with the rear directly against the wall, or with wall spacer brackets attached (see below) then with these directly against the wall.\*
- Always position the appliance with the rear directly on the wall.\*
- Use in hazardous areas is not permitted.

#### 3.1.3 Integration into a kitchen unit

- You can convert the appliance with kitchen cabinets. (see 3.14 Integrating the appliance into a kitchen unit)

### 3.2 Appliance dimensions

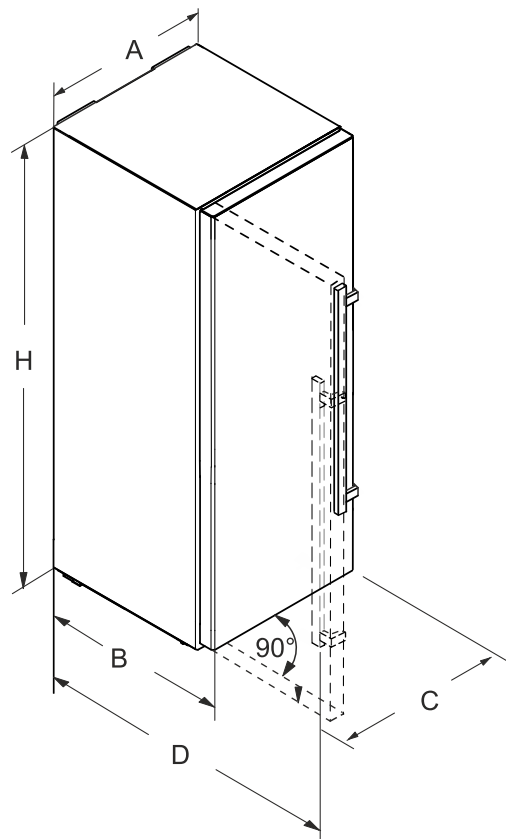

Fig. 2

SFN.. 52..	
H	1855 mm
A	597 mm
B	675 mm <sup>x</sup>
C	654 mm
D	1222 mm <sup>x</sup>

<sup>x</sup> This dimension increases by 15 mm on appliances with attached wall spacer brackets. (see 3.9 Mounting wall spacers\*) \*

## 3.3 Ventilation requirements

### NOTICE

Danger of overheating due to insufficient air ventilation!  
The compressor may be damaged if there is insufficient air ventilation.

- ▶ Take care to ensure adequate air ventilation.
- ▶ Observe the ventilation requirements.

If the appliance is integrated into a kitchen unit, the following ventilation requirements must be observed:

- As a general rule: the larger the ventilation cross section, the more energy the appliance will be able to save.

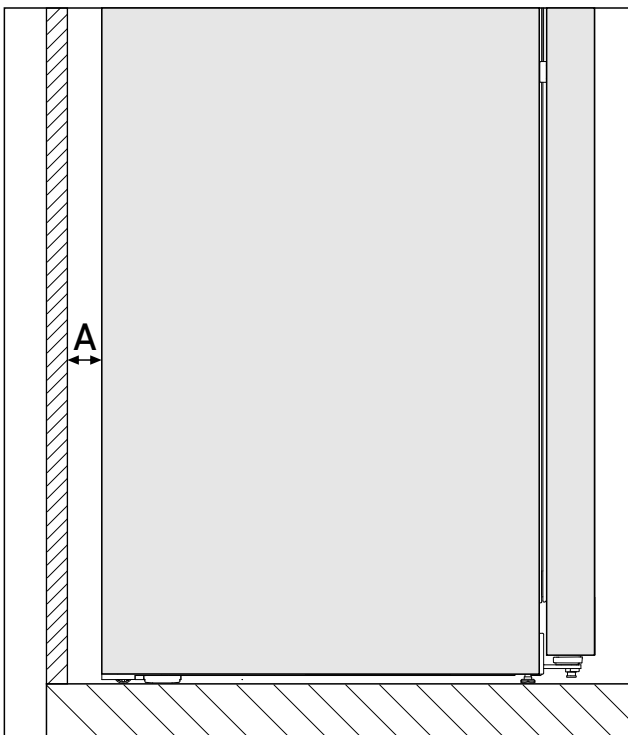

Fig. 3 \*

Wall gap A
25 mm

The energy consumption has been determined with a gap of Fig. 3 (A) between the rear of the appliance and the wall. If the wall gap is less than Fig. 3 (A), this does not affect the appliance's operability but the energy consumption does increase slightly at a smaller wall gap.

## 3.4 Connection dimensions for the power supply

The connection to the power supply is on the rear of the appliance. To connect your appliance safely, ensure that the following requirements are met:

- ❑ Dimensions for the connection to the power supply are known and are adhered to. See table below.
- ❑ Connection to the power supply according to the instructions. (see 3.16 Connecting the appliance to the power supply)

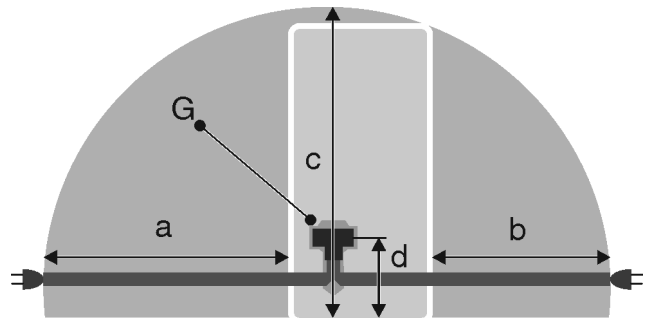

Fig. 4 Fridge/freezer combinations / freezers / full-capacity BioFresh appliances

- (a) Maximum available length of the mains connection cable
- (b) Maximum available length of the mains connection cable
- (c) Maximum available vertical length of the mains connection cable
- (d) Gap between appliance plug and floor
- (G) Appliance plug

For 600 mm wide appliances:	
a	~ 1800 mm
b	~ 1400 mm
c	~ 2100 mm
d	~ 200 mm

## 3.5 Transporting the appliance

### 3.5.1 Transporting the appliance for initial use

Ensure that the following requirements are met:

- ❑ The appliance is packaged.
- ❑ The appliance is upright.

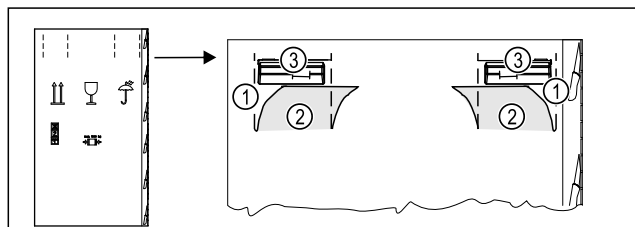

Fig. 5

- ▶ Press the packaging cardboard into the perforation Fig. 5 (1) at the top.
- ▶ Pull out any tabs Fig. 5 (2) that have been pushed in.
- ▶ Carrying handle Fig. 5 (3) visible on the right and left.
- ▶ Hold the appliance by the carrying handles Fig. 5 (3).
- ▶ Transport the appliance with the help of two people.
- ▶ Unpacking the appliance. (see 3.6 Unpacking the appliance)

# Setting up and connecting

## 3.5.2 Transporting the appliance after initial use

Observe the following instructions if you wish to transport or move the appliance again after initial use.

Ensure that the following requirements are met:

- The appliance is emptied.
- The appliance is upright.
- Appliance with door(s): Door is secured against accidental opening.
- Appliance with telescopic unit: The telescopic unit is secured against accidental opening.
- Appliance with adjustable feet: Adjustable feet are screwed in.
- ▶ Hold the appliance by the carrying handles.
- ▶ Transport the appliance with the help of two people.

After transport:

- ▶ Unscrew the adjustable feet on the appliance.
- ▶ Align the appliance. (see 3.11 Setting up the appliance so that it is level)

## 3.6 Unpacking the appliance





Before you connect the appliance, report any damage immediately to the delivery company.

- ▶ Check the appliance and the packaging for damage during transport. Contact the supplier immediately if you suspect any level of damage.
- ▶ Remove all materials from the back or the side walls of the appliance that may prevent proper installation or ventilation.
- ▶ Remove all protective films from the appliance. Do not use sharp or pointed objects for this.

## 3.7 Explanation of symbols used

	There is a danger of injury during this step! Observe the safety instructions!
	The instruction is valid for several models. Only perform this step if it applies to your appliance.
	For installation, please refer to the detailed description in the text section of the instructions.
	Section is valid for either a single-door appliance or a double-door appliance.
	Choose between the following options: Appliance with door hinge on the right or appliance with door hinge on the left.
	Installation step required for IceMaker and/or InfinitySpring.

	Only loosen or lightly tighten the screws.
	firmly tighten the screws.
	Check whether the following step is necessary for your model.
	Check that the components used are correctly installed/fitted.
	Measure the specified dimension and correct if necessary.
	Tool for installation: Metre stick
	Tool for installation: Cordless screwdriver and use
	A lengthwise bit insert is recommended for good access to the screws.
	Tool for installation: Spirit level
	Tool for installation: Open-end wrench with AF 7 and AF 10
	Two people are required for this step.
	The step takes place at the marked location on the appliance.
	Aid for installation: String
	Aid for installation: Protractor

	Aid for installation: Screwdriver
	Aid for installation: Scissors
	Aid for installation: Marking pen, wipeable
	Included: Remove components
	Dispose of components that are no longer required in accordance with local regulations.

## 3.8 Door hinge change

### Tools

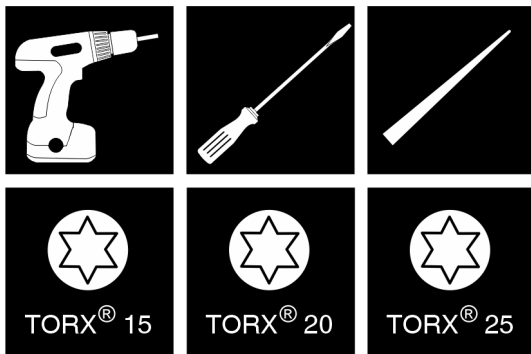

Fig. 6

### NOTICE

Risk of damage due to door collision!  
Damage to the appliances with Side-by-Side positioning. If you set up two appliances next to each other in a specific Side-by-Side arrangement, the door hinge of both appliances is preset at the factory.

- ▶ Side-by-Side positioning: Do not change the door hinge.

These sections apply for appliances **without a soft stop mechanism**:

- For appliances **without** a soft stop mechanism
- For all appliances

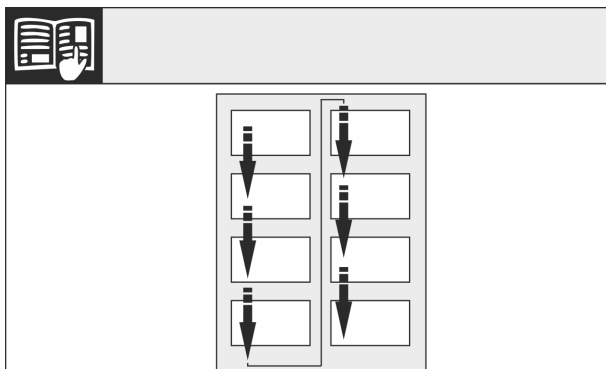

Fig. 7

Remember the reading direction.

### 3.8.1 Appliances without closing damper: Removing covers

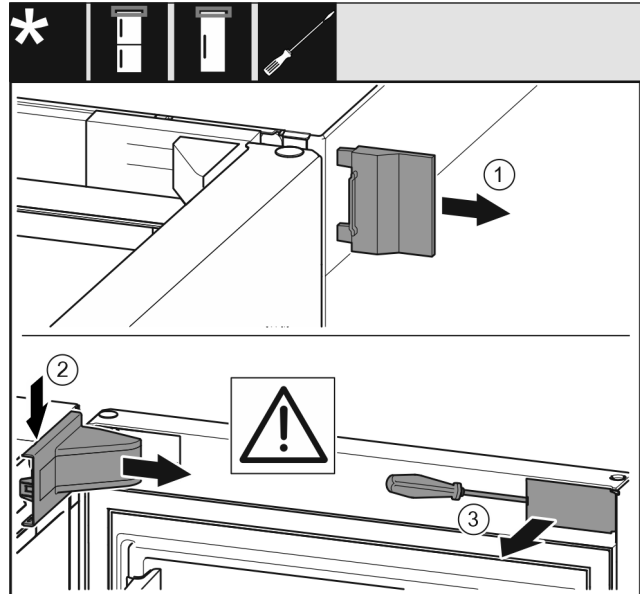

Fig. 8

- ▶ Open the door.
- ▶ Remove the outer cover (1).
- ▶ Disengage and remove the swap bearing block cover (2).

### NOTICE

Risk of damage from screwdrivers!  
If you damage the door seal, the door will not close properly resulting in inadequate cooling.

- ▶ Use a screwdriver carefully as an aid.
- ▶ Do not damage the door seal with the screwdriver.
- ▶ Use a screwdriver to disengage the cover (3) on the outside of the door and swivel it to the side.

# Setting up and connecting

## 3.8.2 Detaching the door

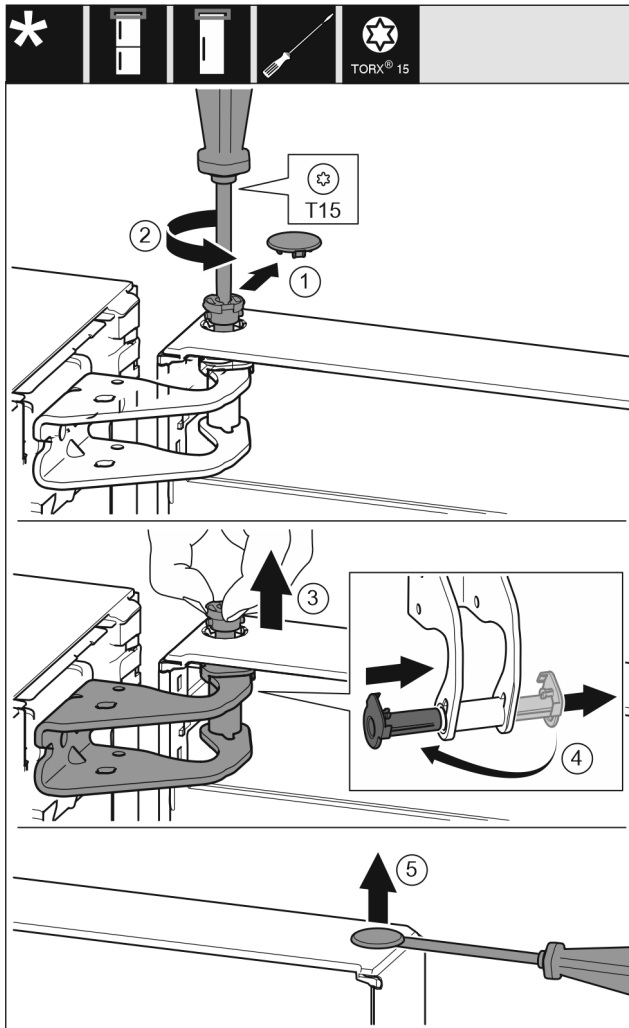

Fig. 9

- ▶ Carefully remove the cover (1).
- ▶ Use screwdriver to loosen the bolts (2) a little.



### CAUTION

Danger of injury due to door tipping out!  
If you remove the bolt on the door completely, the door may tilt out and you may injure yourself.

- ▶ Hold the door firmly before removing the bolt.
- ▶ Hold door in place.
- ▶ Pull out the bolt (3) with your fingers.
- ▶ Pull the bearing bush (4) out of the guide.
- ▶ Insert the bearing bush (4) on the other side and engage.
- ▶ Lift the door and put it to one side.
- ▶ Carefully lift and remove the cover (5) with a screwdriver.

## 3.8.3 Relocating the upper bearing components

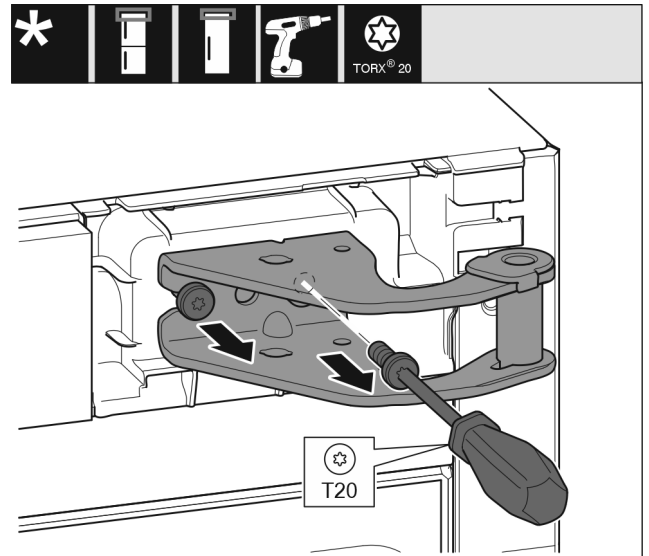

Fig. 10

- ▶ Unscrew the screws.
- ▶ Lift and remove the swap bearing block.



### WARNING

Danger of injury due to door falling out!  
If the bearing parts are not screwed on tightly enough, the door may fall out. This can result in serious injuries. In addition, the door may not close with the result that the appliance does not cool properly.

- ▶ Screw on the bearing brackets/bearing pins tightly with 4 Nm.
- ▶ Check all screws and retighten them if necessary.

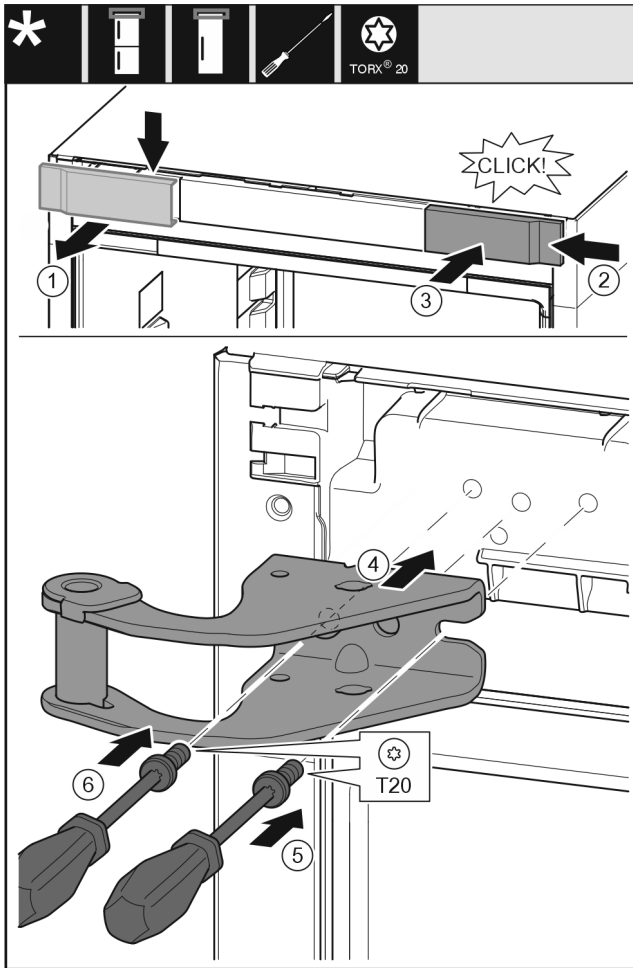

Fig. 11

- ▶ Remove the cover (1) from above towards the front.
- ▶ Turn the cover (2) by 180° and attach to the other side from the right.
- ▶ Engage the cover (3).
- ▶ Place the top swap bearing block (4).
- ▶ Screw the screw (5) tight.
- ▶ Screw the screw (6) tight.

### 3.8.4 Moving the lower bearing parts to the other side

For all appliances:



#### WARNING

Danger of injury due to door falling out!  
If the bearing parts are not screwed on tightly enough, the door may fall out. This can result in serious injuries. In addition, the door may not close with the result that the appliance does not cool properly.

- ▶ Screw on the bearing brackets/bearing pins tightly with 4 Nm.
- ▶ Check all screws and retighten them if necessary.

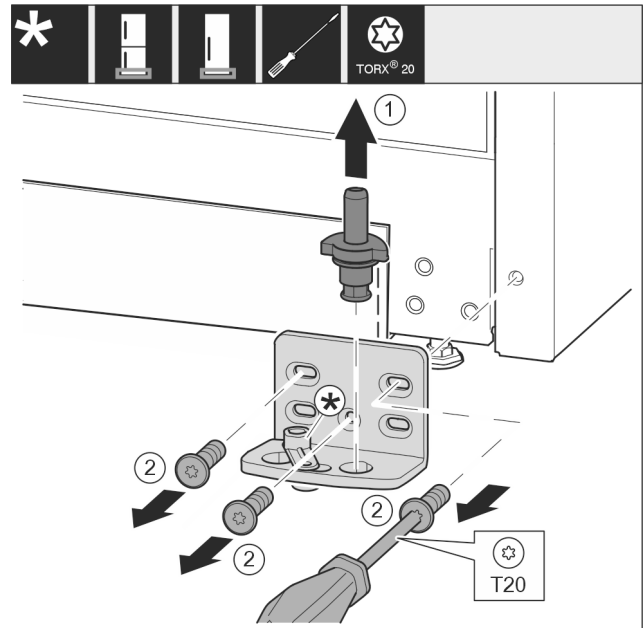

Fig. 12

- ▶ Pull the bearing bolt Fig. 12 (1) out upwards completely.
- ▶ Use screwdriver to unscrew the screws Fig. 12 (2) and remove the swap bearing block.

For appliances without a soft stop:

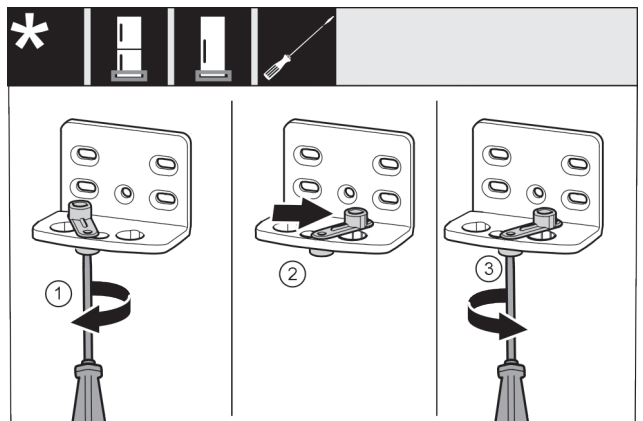

Fig. 13

- ▶ Use screwdriver to loosen the screw Fig. 13 (1).
- ▶ Lift the door closing aid Fig. 13 (2) and turn 90° clockwise in the hole.
- ▶ Tighten screw Fig. 13 (3) with screwdriver.

For all appliances:

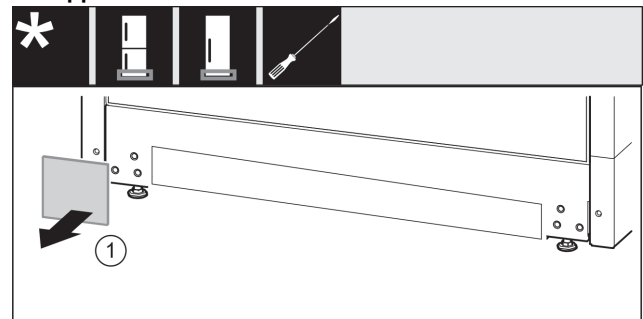

Fig. 14

- ▶ Remove cover Fig. 14 (1).

# Setting up and connecting

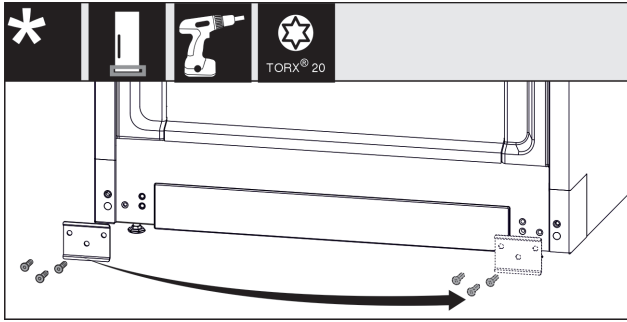

Fig. 15

- Unscrew the plate Fig. 15 (1), move it to the other side and screw it back on.

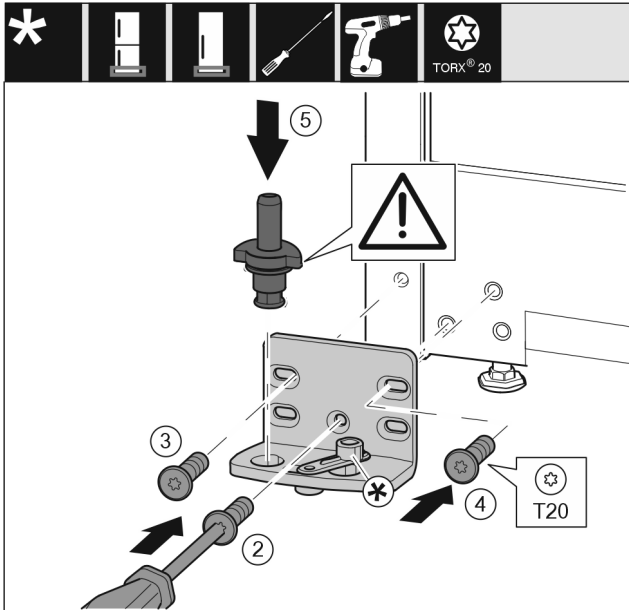

Fig. 16

- Place the swap bearing block on the other side and use a screwdriver to screw it on. Start with the screw Fig. 16 (2) at the bottom in the middle.
- Tighten screw Fig. 16 (3) and screw Fig. 16 (4).
- Insert the bearing bolt Fig. 16 (5) completely. Ensure that the latching cam is pointing towards the rear.

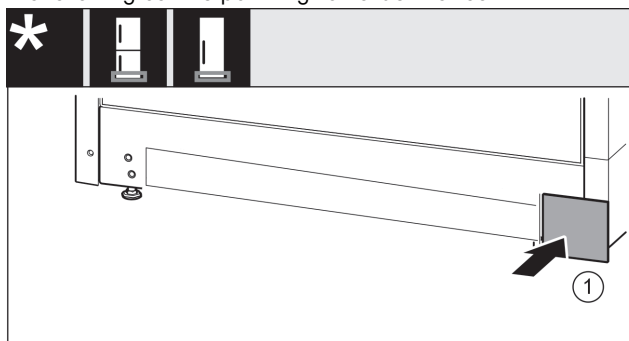

Fig. 17

- Re-attach the cover Fig. 17 (1) to the other side.

## 3.8.5 Moving the door bearing parts to the other side

For appliances without a soft stop:



### WARNING

Danger of injury due to door falling out!

If the bearing parts are not screwed on tightly enough, the door may fall out. This can result in serious injuries. In addition, the door may not close with the result that the appliance does not cool properly.

- Screw on the bearing brackets/bearing pins tightly with 4 Nm.
- Check all screws and retighten them if necessary.

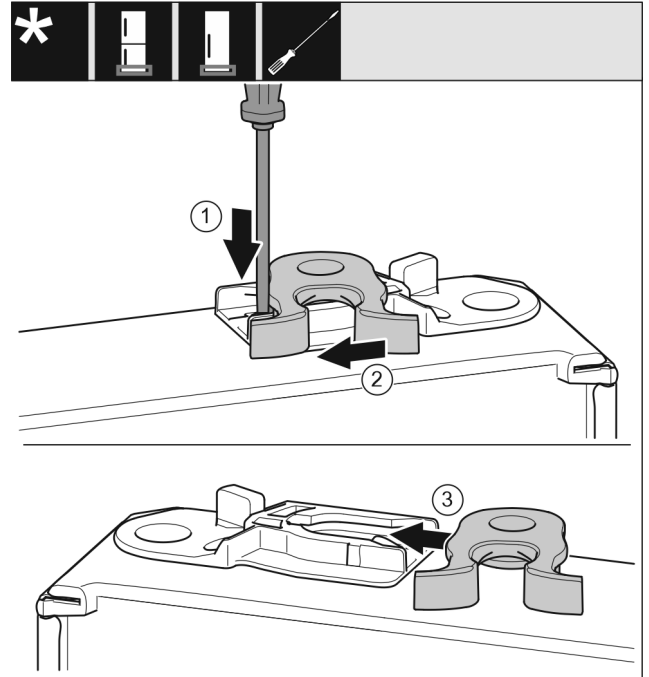

Fig. 18

- The bottom side of door faces upwards: Turn the door.
- Use a slotted screwdriver to push the tab Fig. 18 (1) downwards.
- Pull the closing hook Fig. 18 (2) out of the guide.
- Insert the closing hook Fig. 18 (3) into the guide on the other side.
- The upper side of door faces upwards: Turn the door.

## 3.8.6 Moving the handles to the other side

For all appliances:

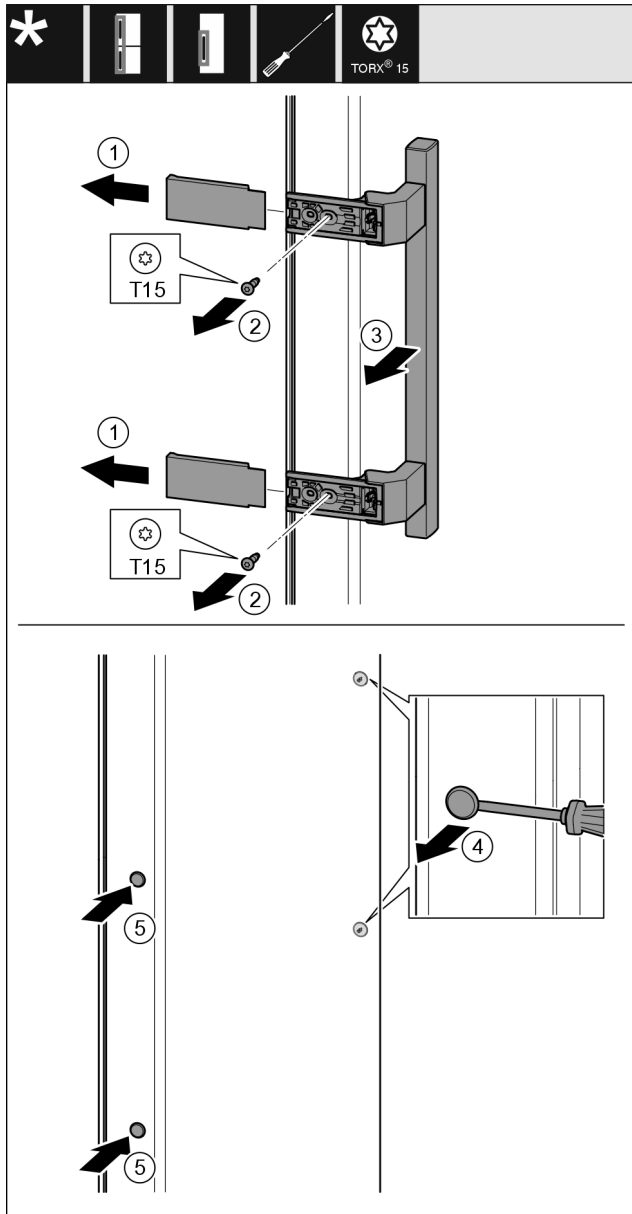

Fig. 19

- ▶ Remove the cover Fig. 19 (1).
- ▶ Unscrew screws Fig. 19 (2) with screwdriver.
- ▶ Remove the handle Fig. 19 (3).
- ▶ Use a slotted screwdriver to lift the side plug Fig. 19 (4) carefully and pull it out.
- ▶ Re-insert the plug Fig. 19 (5) on the other side.

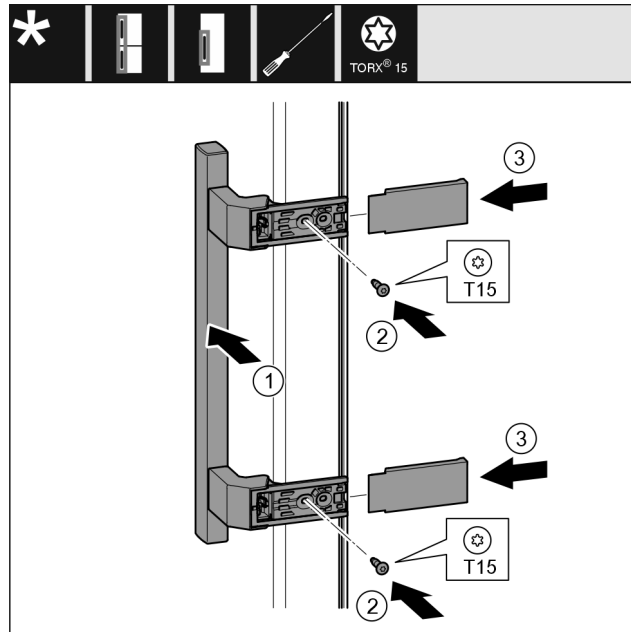

Fig. 20

- ▶ Place the handle Fig. 20 (1) on the opposite side.
- ▶ The screw holes must be exactly above each other.
- ▶ Tighten screws Fig. 20 (2) with screwdriver.
- ▶ Place the covers Fig. 20 (3) on the side and push them on.
- ▶ Ensure that they latch into place.

### 3.8.7 Fitting the door

- ▶ Place the door on the lower bearing pins.

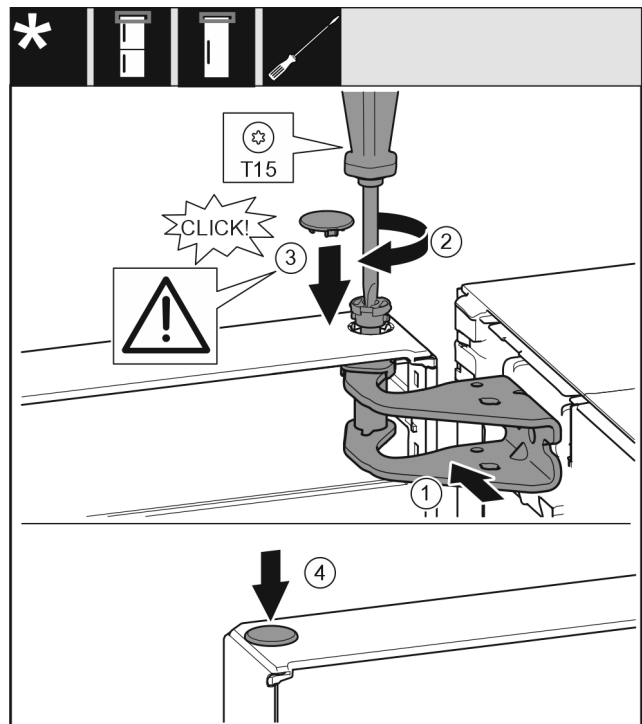

Fig. 21

- ▶ Align the top door with the opening in the swap bearing block Fig. 21 (1).
- ▶ Insert the bolt Fig. 21 (2) and use screwdriver to tighten it.
- ▶ Insert the cover Fig. 21 (3).
- ▶ Check that the cover Fig. 21 (3) is resting on the door.
- ▶ Insert the cover Fig. 21 (4).

### 3.8.8 Aligning the door

For all appliances:

# Setting up and connecting



## WARNING

Danger of injury due to door falling out!

If the bearing parts are not screwed on tightly enough, the door may fall out. This can result in serious injuries. In addition, the door may not close with the result that the appliance does not cool properly.

- ▶ Screw the bearing brackets on firmly with 4 Nm.
- ▶ Check all screws and retighten them if necessary.

- ▶ Align the doors flush with the appliance housing using the two slots in the bearing bracket if needed. To do this undo the middle screw in the bottom bearing bracket with the T20 tool supplied. Undo the remaining screws a little with the T20 tool or with a T20 screwdriver and align using the slotted holes.
- ▶ Prop up the door: Take off the adjustable foot on the bearing bracket using the open-ended wrench SW10 until it comes into contact with the floor, then turn an additional 90°.

### 3.8.9 Fitting the covers

For appliances without a soft stop:

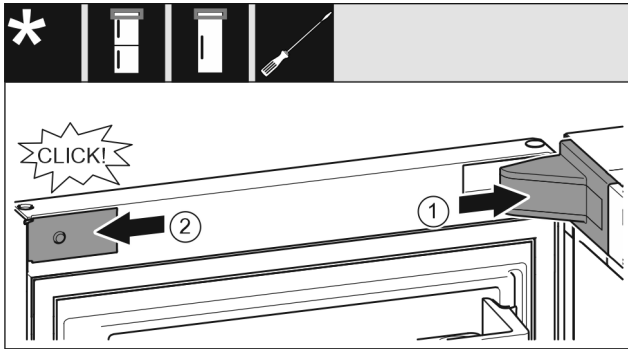

Fig. 22

The door is open 90°.

- ▶ Put the swap bearing block cover Fig. 22 (1) on and engage, push apart carefully if required.
- ▶ Place the trim Fig. 22 (2) on the side and engage.

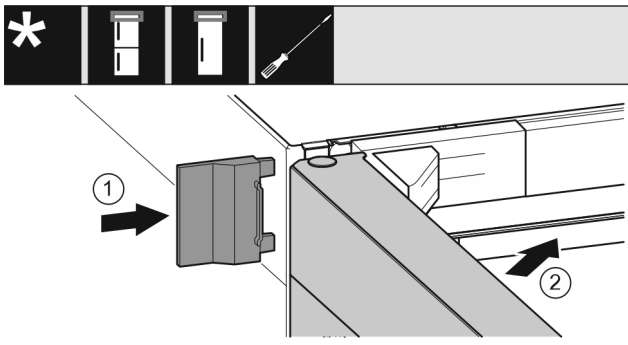

Fig. 23

- ▶ Push the outer cover Fig. 23 (1) on.
- ▶ Close the upper door Fig. 23 (2).

### 3.9 Mounting wall spacers\*

With wall spacers, your device achieves the declared energy consumption and no condensation forms in high ambient humidity. The device is fully functional without the spacer brackets, but its energy consumption will be slightly higher.

If you insert the wall spacers, then the device depth increases by approx. 15 mm.\*

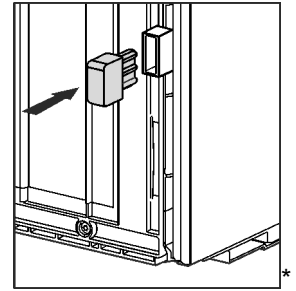

- ▶ Appliance with enclosed wall spacers: Insert the wall spacers on the rear of the appliance at the bottom left and right.

### 3.10 Setting up the appliance



## CAUTION

Risk of injury due to heavy appliance!

- ▶ Have two people transport the appliance to its installation site.



## WARNING

Risk of fire due to short circuit!

- ▶ When you set the appliance up: do not kink, jam or damage the mains cable.
- ▶ The appliance must not be operated with a defective mains cable.



## WARNING

Fire hazard and danger of damage!

- ▶ Do not place appliances emitting heat e.g. microwaves, toasters etc. on the appliance!

Ensure that the following conditions are met:

- Only move the device when it is not loaded.
- Only install the appliance with help.
- ▶ Remove the mains cable from the package.
- ▶ Plug the mains cable's IEC socket completely into the appliance plug on the back of the appliance. Ensure that the IEC socket is tight.
- ▶ Use a cord to lay the mains plug to a freely accessible socket if required.

### 3.11 Setting up the appliance so that it is level

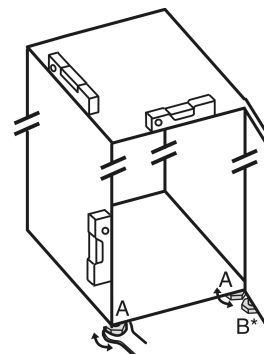

Fig. 24

- ▶ Unscrew the adjustable feet Fig. 24 (A) using the enclosed open-end spanner and a spirit level until the appliance is firmly aligned and level.



## CAUTION

Risk of injury and damage due to the appliance tipping over! If the additional adjustable foot on the lower swap bearing block does not rest properly on the floor, the appliance may tip over. This can lead to property damage and injuries.

► Unscrew the additional adjustable foot on the swap bearing block as instructed.

► Unscrew the adjustable foot *Fig. 24 (B)* on the swap bearing block with the enclosed open-end spanner until it rests on the floor.

► Turn the adjustable foot *Fig. 24 (B)* 90° further.

► The appliance is aligned.

## 3.12 After setting up

► Remove all transport safety components.

► Take off the protective film from the exterior of the appliance.

► Take off the protective film from the trim panels and drawer fronts.\*

► Clean the appliance. (see operating instructions)

► Note the type (model, number), appliance designation, appliance/serial number, purchase date and dealer's address.

## 3.13 Installing multiple appliances

The appliances have been developed for different installation methods. If you wish to install several appliances next to each other or on top of each other, ensure that the following requirements are met:

Only install appliances next to or on top of each other if they have been developed for this.

Observe notices and the following table.

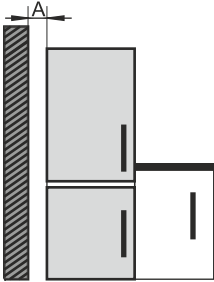
Model	Installation method
All models	Standalone
Models with a model designation starting with <b>S...</b>	Side-by-Side (SBS)
	 <p>If you do not comply with this gap, condensation may form on the appliance's side wall.</p> <p><b>On an exterior wall: A of 70 mm</b></p>

*Models and their installation method*

### 3.13.1 Side-by-Side mounting

You can place your Side-by-Side-compatible freezer directly next to the Side-by-Side-compatible fridge without installation.

**Installation dimensions:**

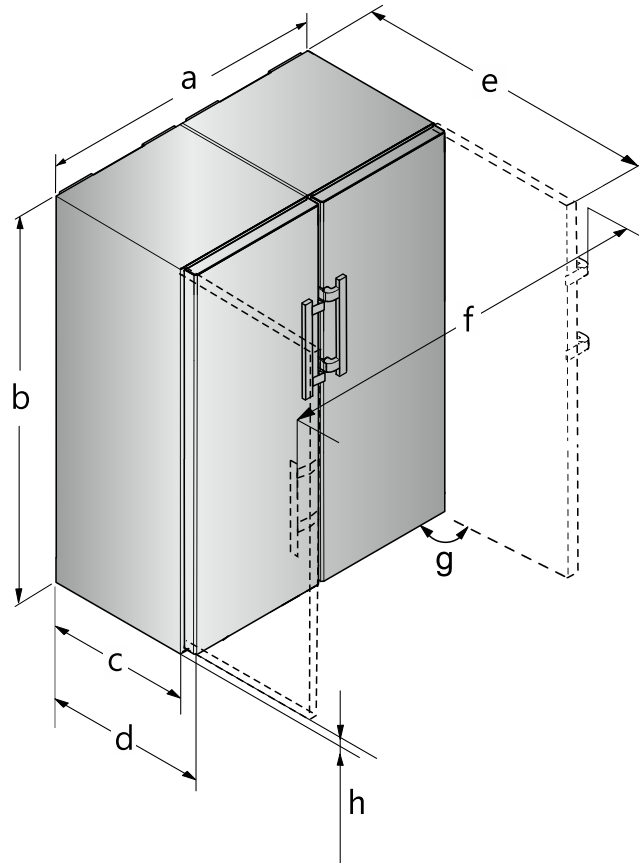

*Fig. 25*

SFN.. 52.. / SR.. 52..	
a	1194 mm
b	1855 mm
c	600 mm
d	675 mm
e	1222 mm
f	1308 mm
g	90°
h	35 mm

The freezer is equipped with a side panel heater on the right-hand side to prevent condensation. The freezer must therefore be positioned to the left of the fridge when viewed from the front.

► Place the freezer to the left of the fridge.

## 3.14 Integrating the appliance into a kitchen unit

The appliance can be integrated into a kitchen unit. Please observe the following installation conditions:

- If you fit a stacking cabinet above the appliance, you must allow for a ventilation cross-section with the appropriate depth at the rear of the stacking cabinet.
- If you place the appliance with the hinges next to a wall, you must take the distance to the side of the appliance into account.
- To ensure that the door can be opened fully, the appliance must protrude beyond the front thickness. Depending on the niche depth, the appliance may protrude further.

# Setting up and connecting



## WARNING

Risk of fire due to short circuit!

- ▶ When you set the appliance up: do not kink, jam or damage the mains cable.
- ▶ The appliance must not be operated with a defective mains cable.

Ensure that the following requirements are met:

- ❑ The socket is easily accessible and is not behind the appliance.
- ❑ Ventilation requirements are met. (see 3.3 Ventilation requirements).
- ❑ Connection dimensions are taken into account. (see 3.16 Connecting the appliance to the power supply)
- ❑ Wall spacers are fitted.\*

### 3.14.1 Niche dimensions for appliances with lever handle

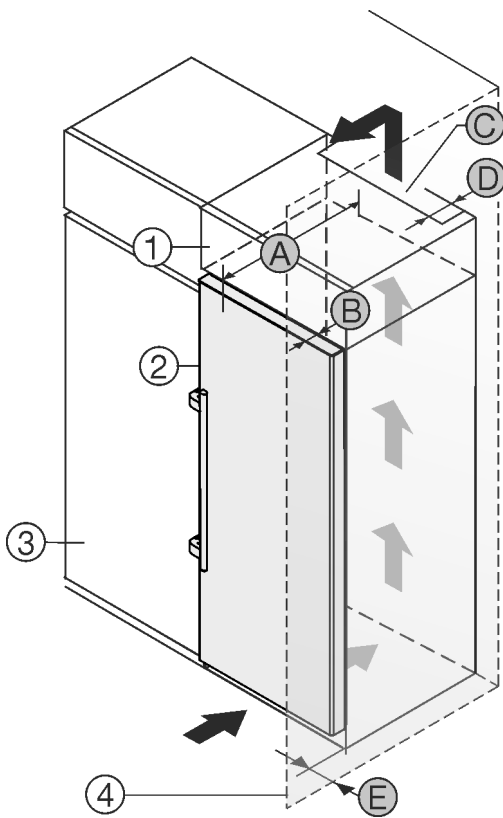

Fig. 26

- (1) Top Unit
- (2) Appliance
- (3) Kitchen cupboard
- (4) Wall
- (A) Appliance depth
- (B) Door depth
- (C) Ventilation cross-section
- (D) Distance from rear of the appliance
- (E) Distance to the side of the appliance

Dimensions with lever handle:	
A	675 mm <sup>x</sup>
B	75 mm
C	min. 300 cm <sup>2</sup>
D	min. 50 mm
E	min. 57 mm

<sup>x</sup> On devices with wall spacer brackets, this dimension increases by 15 mm.\*

## 3.15 Disposing of packaging



## WARNING

Danger of suffocation due to packing material and plastic film!

- ▶ Do not allow children to play with packing material.

The packaging is made of recyclable materials:

- corrugated board/cardboard
- expanded polystyrene parts
- polythene bags and sheets
- polypropylene straps
- nailed wooden frame with polyethylene panel\*
- ▶ Take the packaging material to an official collecting point.

## 3.16 Connecting the appliance to the power supply



## WARNING

Danger of electric shock and injury due to damaged appliance or damaged mains cable!  
 Danger of cuts and fatal injuries. If the appliance or the mains cable is damaged during transport, you may be electrocuted. You could also cut yourself on damaged parts of the appliance housing.

- ▶ Check the appliance and the mains cable for damage after transport.
- ▶ Never put the appliance into operation if the appliance or the mains cable are damaged.
- ▶ Contact Customer Service.

You can connect your appliance to the mains using the power cable supplied separately. The mains power cable has an appliance coupler at one end and a mains plug at the other end.

Make sure that the following requirements are fulfilled:

- The appliance and power cable are undamaged.
- The appliance is set up in accordance with the regulations. (see 3.9 Mounting wall spacers\*)
- Requirements for the electrical connection are met.
- Dimensions for connection in accordance with regulations are known and observed. (see 3.4 Connection dimensions for the power supply)
- Mains voltage and frequency correspond to the specifications on the type plate.
- The socket is earthed according to the regulations and fused.
- The fuse tripping current is between 10 A and 16 A.
- The socket is easily accessible and is not behind the appliance. (see 3.4 Connection dimensions for the power supply)

## NOTICE

Danger of damage to incorrect operation!  
 Damage to the electrical components of the appliance.  
 ▶ Only use the supplied mains cable.



## WARNING

Danger of fire due to incorrect connection!  
 Burns.

- Damage to the appliance.
- ▶ Do not use an extension cable.
- ▶ Do not use distributor blocks.

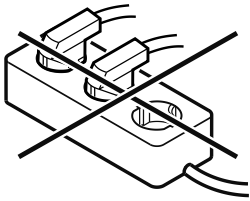

## NOTICE

Danger of damage to incorrect connection!

Damage to the appliance.

▶ Do not connect the appliance to a stand-alone inverter, e.g. solar power systems and petrol generators.

- ▶ Connect the mains cable plug to the power supply. Ensure that the plug is tightly in the socket.
- ▶ The Liebherr logo appears in the display.
- ▶ The display switches to the standby symbol.
- ▶ If no action occurs within 60 seconds: The standby symbol fades or disappears.
- ▶ The appliance is connected. For information regarding first use, see the following section or the operating instructions.

## 4 Functionality of the Touch display

You operate your appliance using the Touch display. You select appliance functions in the Touch display (hereafter referred to as display) by tapping them. If you do not perform any action on the display for 10 seconds, the display either jumps back to the higher-level menu or directly to the status display.

### 4.1 Navigation and symbol explanation

In the illustrations, different symbols are used to navigate the display. The following table describes these symbols.

Symbol	Description
	<b>Press the Next navigation arrow:</b> Navigates to the next option in the menu.
	<b>Press the Back navigation arrow:</b> Jumps back one option in the menu.
	<b>Press the navigation arrow several times in succession:</b> Navigates in the menu to the desired function.
	<b>Press the Confirm symbol:</b> Activates/deactivates function. Opens submenu.
	<b>Press the Confirm symbol together with the back icon:</b> Jumps back one menu level.

Symbol	Description
	<b>Arrow with clock:</b> It takes more than 10 seconds for the following message to appear in the display.
	<b>Arrow with a time indication:</b> It takes the specified amount of time until the following message appears in the display.
	<b>“Open Settings menu” symbol:</b> Navigates to the Settings menu and opens the settings menu. If necessary: Navigate to the desired function in the Settings menu. (see 4.2.1 Opening the Settings menu)
	<b>“Open Advanced menu” symbol:</b> Navigates to the Advanced menu and opens the advanced menu. If necessary: Navigate to the desired function in the Advanced menu. (see 4.2.2 Opening the Advanced menu)
No action for 10 seconds	If you do not perform any action on the display for 10 seconds, the display either jumps back to the higher-level menu or directly to the status display.
Close the door and open it again.	If you close the door and immediately open it again, the display jumps directly back to the status display.

*Note: Illustrations of the display are shown in the English version.*

### 4.2 Menus

The appliance functions can be found in various menus.

Menu	Description
Main menu	When you switch the appliance on, you are automatically in the main menu. From here you can navigate to the most important appliance functions, to the Settings menu and to the Advanced menu.
 Settings menu	The Settings menu contains additional appliance functions for setting up your appliance. (see 4.2.1 Opening the Settings menu)
Advanced menu	The advanced menu contains special appliance functions for setting up your appliance. Access to the Advanced menu is protected by the numerical code <b>151</b> . (see 4.2.2 Opening the Advanced menu)

# Putting into operation

## 4.2.1 Opening the Settings menu

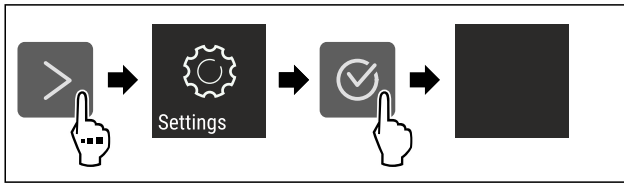

Fig. 27 Example illustration

- ▶ Carry out action steps according to the illustration.
- ▶ Settings menu is open.
- ▶ If necessary: Navigate to the desired function.

## 4.2.2 Opening the Advanced menu



Fig. 28

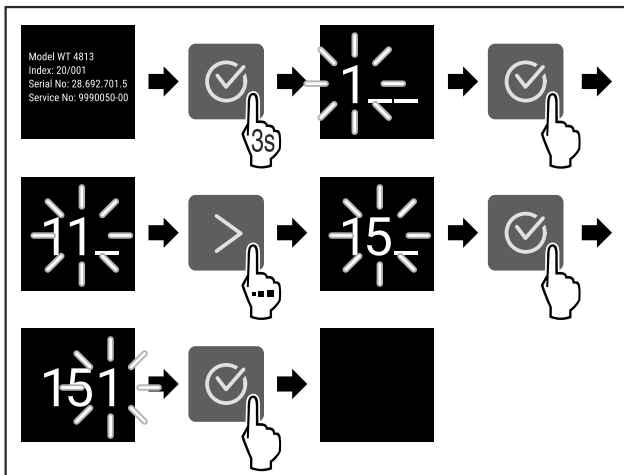

Fig. 29 Example illustration, access with numerical code **151**

- ▶ Carry out action steps according to the illustration.
- ▶ The expanded menu is open.
- ▶ If necessary: Navigate to the desired function.

## 4.3 Sleep mode

If you do not touch the display for 1 minute, the display switches to sleep mode. In sleep mode, the display brightness is dimmed.

### 4.3.1 Ending sleep mode

- ▶ Press any navigation key.
- ▶ Sleep mode is ended.

# 5 Putting into operation

## 5.1 Switching on appliance (first use)

Make sure that the following requirements are fulfilled:

- The appliance has been installed and connected in accordance with the installation instructions.
- All adhesive strips, adhesive and protective films and transport locks are removed from inside and on the appliance.
- All marketing leaflets are removed from the drawers.
- You are familiar with the functionality of the Touch display. (see 4 Functionality of the Touch display)

**Switch on the appliance using the Touch display:**

- ▶ If the display is in sleep mode: Press the confirmation symbol.
- ▶ Carry out action steps according to the illustration.

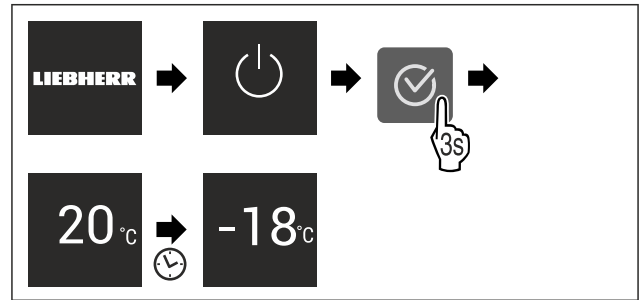

Fig. 30 Example illustration

- ▶ Status display appears.
- ▶ The appliance cools to the temperature set at the factory.
- ▶ The appliance starts in demo mode (status display with DEMO appears): If the appliance starts in demo mode, you can deactivate demo mode within the next 5 minutes. (see Demo mode)

### More information:

- Start the SmartDevice for the first time. (see 2.3 SmartDevice) and (see WiFi)

### Note

The manufacturer recommends:

- ▶ **Store frozen foods** at -18 °C or colder.
- ▶ Observe the notes on storing food. (see 6.1 Information regarding storage)

### Note

Accessories can be purchased from the Liebherr-Hausgeräte store at [home.liebherr.com/shop/de/deu/zubehor.html](http://home.liebherr.com/shop/de/deu/zubehor.html).

# 6 Storage

## 6.1 Information regarding storage



### WARNING

Fire hazard from electrical appliances!

If you use electrical appliances in the food area of your appliance, they can cause a fire.

- ▶ Do not use electrical appliances in the food area of the appliance unless recommended by the manufacturer.

### Note

The energy consumption increases and the cooling power goes down if ventilation is not sufficient.

- ▶ Always keep air slots clear.

Observe the following specifications for storage:

- Package food properly.
- Package raw meat or fish in clean, closed containers. This will prevent meat or fish from touching or dripping onto other food.
- Leave space between goods to ensure good air circulation.
- Store food according to the instructions on the packaging.
- Always observe the best-before date indicated on the packaging.

### Note

Failure to follow these guidelines can lead to foodstuffs spoiling.

## 6.2 Freezer compartment

Here, a dry, frosty storage climate is created at -18 °C. A frosty storage climate is suitable for storing frozen food for several months, for making ice cubes or freezing fresh food.

### 6.2.1 Freezing food

#### Freezing quantity

The maximum amount of fresh food that you can freeze within 24 hours is specified on the type plate (see 11.5 Model plate) under "Freezing capacity ... kg/24h".

To ensure that food quickly freezes through, adhere to the following quantities per package:

- Fruit and vegetables up to 1 kg
- Meat up to 2.5 kg

#### Freezing food using SuperFrost

Depending on the quantity to be frozen, you can activate SuperFrost before freezing in order to achieve lower freezing temperatures. (see SuperFrost)

- ▶ Activate SuperFrost if the amount of food you have to freeze is more than approx. 2 kg.

The time at which you activate SuperFrost depends on the amount of food you have to freeze:

Freezing quantity	Time at which you should activate SuperFrost
Small amount of food to freeze	Activate SuperFrost about 6 hours before freezing. As soon as the appliance automatically deactivates SuperFrost, you can rearrange the food.
Maximum amount of food to freeze	Activate SuperFrost about 24 hours before freezing. As soon as the appliance automatically deactivates SuperFrost, you can rearrange the food.

#### Arranging your food properly



#### CAUTION

Risk of injury from broken glass!  
Bottles and cans with beverages can burst during freezing. This applies in particular to carbonated beverages.

- ▶ Only freeze bottles and cans with beverages if you have activated the BottleTimer function in the SmartDevice app.

Freezing quantity	Arranging your food properly
Small amount of food to freeze	Place packaged food in the top drawer. If possible, place groceries at the back of the drawer near the rear wall.
Maximum amount of food to freeze	Distribute packaged groceries throughout all drawers, but only place frozen food in the bottom drawer. If possible, place groceries at the back of the drawer near the rear wall.

### 6.2.2 Defrosting food



#### WARNING

Risk of food poisoning!

- ▶ Do not re-freeze thawed food.
- ▶ Use defrosted foodstuff as soon as possible.

You can defrost food in several ways:

- In a fridge
- In the microwave
- In the oven/fan-assisted oven
- At room temperature
- ▶ Take out only as much food as necessary.

### 6.2.3 Freezer tray

You can freeze berries, herbs, vegetables and other small frozen food in the freezer tray without it all freezing together. The frozen food is less likely to get squashed and subsequent portioning is easier.

- ▶ Distribute food on the freezer tray without packaging and well spaced out.

## 6.3 Storage times

Refer to the specified storage times as a guide.

In the case of foods with a minimum shelf life, the date indicated on the packaging still applies.

Recommended storage period for various types of food		
Ice cream	at -18 °C	2 to 6 months
Sausages, ham	at -18 °C	2 to 3 months
Bread, baked goods	at -18 °C	2 to 6 months
Game, pork	at -18 °C	6 to 9 months
Fatty fish	at -18 °C	2 to 6 months
Lean fish	at -18 °C	6 to 8 months
Cheese	at -18 °C	2 to 6 months
Poultry, beef	at -18 °C	6 to 12 months
Vegetables, fruit	at -18 °C	6 to 12 months

## 7 Saving energy

- Pay attention to good ventilation. Do not cover ventilation holes or grids.
- Always keep the fan air slits clear.
- Do not place the appliance in direct sunlight or near radiators or similar sources of heat.
- If the appliance is placed directly next to an oven, the energy consumption may increase slightly. This is dependent on the service life and usage intensity of the oven.
- Energy consumption depends on the installation conditions, e.g. the ambient temperature. A warmer ambient temperature can increase the energy consumption.
- Open the appliance for as short a time as possible.
- The lower the temperature is set the higher the energy consumption.
- Keep all food properly packed and covered. This prevents frost from forming.
- Inserting warm food: allow to cool down to room temperature first.

# Controls

## 8 Controls

### 8.1 Controls and displays

#### 8.1.1 Status display







Fig. 31

**(1)** Temperature display

The Status display shows the set temperature and is the home display. From there, you can navigate to the options and settings.

#### 8.1.2 Display symbols

Display symbols provide information on the current appliance status:

Symbol	Appliance status
	<b>Standby</b> The appliance or temperature zone is switched off.
	<b>Flashing number</b> Appliance is working. Temperature flashes until the set value is reached.
	<b>Flashing symbol</b> Appliance is working. Setting is made.
	<b>Bar grows steadily</b> Function is activated.

## 8.2 Appliance functions

### 8.2.1 Notes on the appliance functions

The appliance functions are set at the factory so that your appliance is fully functional.

Before you alter, activate or deactivate the device functions, make sure that the following requirements are met:

- You have read and understood the descriptions of how the display works. (see 4 Functionality of the Touch display)
- You have familiarised yourself with the operating and display elements of your appliance.



#### Switching the appliance off and on

Use this function to switch the entire appliance off and on.

##### Switching off the appliance

When you switch the appliance off, then the previously saved settings are saved.

Make sure that the following requirements are fulfilled:

- Handling instructions (see 12 Shutting down) are carried out.



Fig. 32

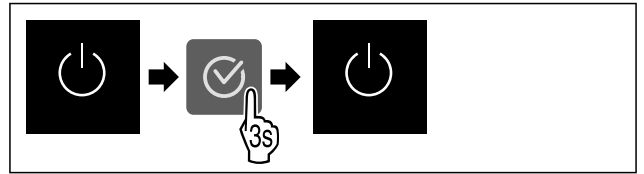

Fig. 33

- ▶ Carry out action steps according to the illustration.
- ▶ Appliance is switched off.
- ▶ The standby symbol appears in the display.
- ▶ Display turns black.

#### Switching on the appliance

If the display is in sleep mode:

- ▶ Press any navigation key.

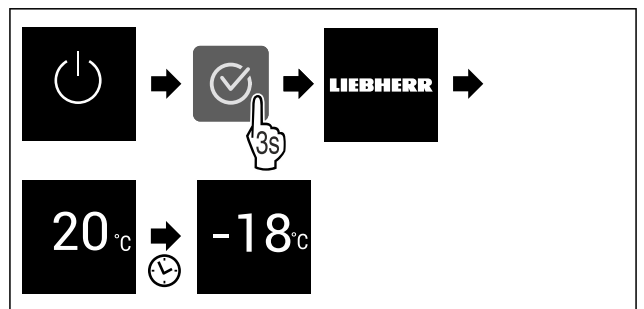

Fig. 34 Example illustration

- ▶ Carry out action steps according to the illustration. When the appliance starts in demo mode:
- ▶ Deactivating demo mode. (see Deactivating demo mode)
- ▶ The appliance is switched on.
- ▶ Previous settings are restored.
- ▶ The appliance cools to the target temperature set.

#### **-18 °C** Temperature

Use this function to set the temperature.

The temperature depends on the following factors:

- Frequency of door opening
- Duration of door opening
- Room temperature of the installation site
- Type, temperature and quantity of food

Freezer compartment	Factory-set temperature	Recommended setting
<b>-18 °C</b>	-18 °C	-18 °C

## Setting the temperature

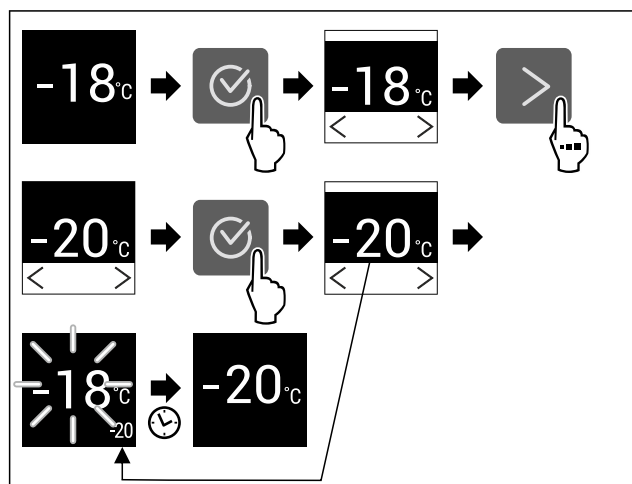

Fig. 35 Example illustration

- ▶ Carry out action steps according to the illustration.
- ▶ Temperature is set.

## SuperFrost

You can use this function to activate or deactivate SuperFrost. If SuperFrost is activated, then the appliance increases the freezing capacity. It allows you to achieve lower freezing temperatures.

Application:

- Quickly freeze fresh food through to the core. This ensures that the nutrition, appearance and taste of frozen food is maintained.
- Increase the cold reserve in stored frozen food before defrosting the appliance.

If the function is active, the appliance operates at higher power. As a result, the appliance's operating noise may be temporarily louder and energy consumption will increase.

If the door is open for too long, e.g. because you are putting food in, the appliance automatically checks whether the actual temperature in the appliance matches the set temperature. If the difference exceeds a certain value, the appliance automatically cools more vigorously. As a result, the temperature shown on the display may be higher than the actual temperature in the appliance. This is normal and your appliance is working correctly.\*

### Activating SuperFrost

Make sure that the following requirements are fulfilled:

- Freezing quantity and time for activation of SuperFrost are taken into account. (see Freezing food using SuperFrost)

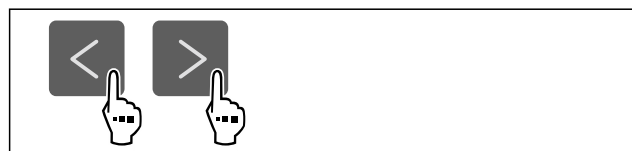

Fig. 36

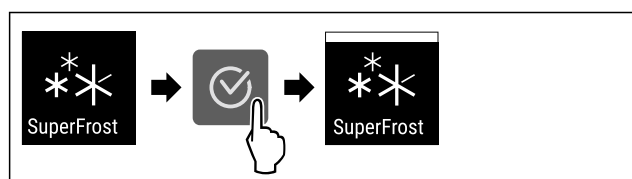

Fig. 37

- ▶ Carry out action steps according to the illustration.

- ▶ SuperFrost is activated.

### Deactivating SuperFrost

SuperFrost is automatically deactivated after 56 to 72 hours depending on the quantity of the food inserted. However, you can also deactivate SuperFrost manually at any time:



Fig. 38

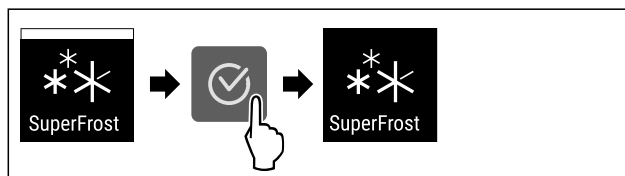

Fig. 39

- ▶ Carry out action steps according to the illustration.
- ▶ SuperFrost is deactivated.
- ▶ The appliance continues to run in normal mode.
- ▶ The appliance cools to the temperature set previously.

## PartyMode

You can use this function to activate or deactivate PartyMode. PartyMode activates various functions that are useful for a party.

PartyMode activates the following functions:

- SuperFrost (see SuperFrost)

You can adjust all listed functions individually and flexibly. When you deactivate PartyMode, all changes are discarded.

If the function is active, the device operates at higher power. As a result, the device's operating noise may be temporarily louder and energy consumption will increase.

### Activating PartyMode



Fig. 40

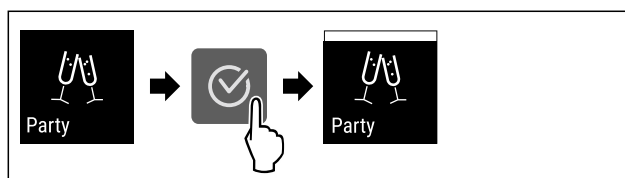

Fig. 41

- ▶ Carry out action steps according to the illustration.
- ▶ PartyMode and the associated functions are activated.
- ▶ The current temperature flashes until the target temperature is reached.

### Deactivating PartyMode

The PartyMode is automatically deactivated after 24 seconds. However, you can also deactivate PartyMode manually at any time:

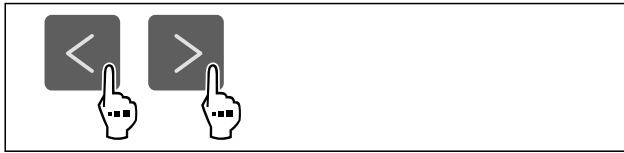

Fig. 42

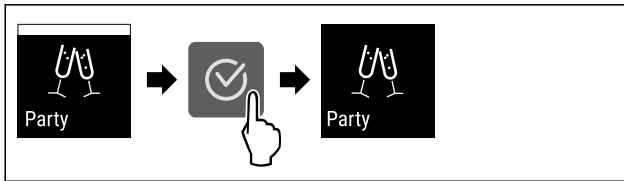

Fig. 43

- ▶ Carry out action steps according to the illustration.
- ▷ PartyMode is deactivated.
- ▷ The appliance cools to the temperature set previously: The current temperature flashes until the target temperature is reached.



## SabbathMode

You can use this function to activate or deactivate SabbathMode. If you activate this function, some electronic functions are switched off. As a result, your device meets the religious requirements for Jewish holidays such as Sabbath and complies with STAR-K Kosher certification.

Device status when SabbathMode is active
The status display shows SabbathMode permanently.
All functions on the display are locked except for the <b>Deactivate SabbathMode function</b> .
Active functions remain active.
The display remains bright when you close the door.
Reminders are not implemented. The set time interval stops.
Reminders and warnings are not displayed.
There is no door alarm.
There is no temperature alarm.
The defrosting cycle operates only for the specified time, without considering the appliance consumption.
After a power failure, the appliance returns to SabbathMode.

*Device status*

### Note

This appliance has certification from the "Institute for Science and Halacha". ([www.machonhalacha.co.il](http://www.machonhalacha.co.il))

You can find a list of STAR-K-certified appliances at [www.star-k.org/appliances](http://www.star-k.org/appliances).

## Activating SabbathMode



### WARNING

Danger of food poisoning from spoiled food!

If you have SabbathMode activated and a power failure occurs, no message appears in the status display about the power failure. Once the power is restored, the appliance continues to operate in SabbathMode. The power failure may mean that food spoils and the consumption of this food could lead to food poisoning.

After a power failure:

- ▶ Do not consume food that was frozen and has thawed out.



Fig. 44

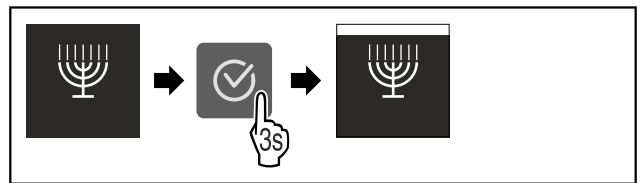

Fig. 45

- ▶ Carry out action steps according to the illustration.
- ▷ SabbathMode is activated.
- ▷ The status display shows SabbathMode permanently.

## Deactivating SabbathMode

The SabbathMode is automatically deactivated after 80 hours. However, you can also deactivate SabbathMode manually at any time:

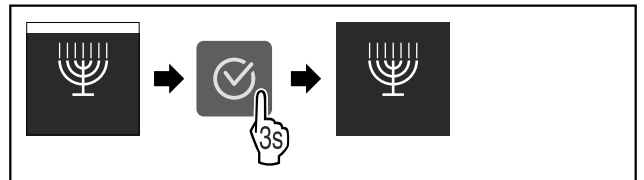

Fig. 46

- ▶ Carry out action steps according to the illustration.
- ▷ SabbathMode is deactivated.



## E-Saver

You can use this function to activate or deactivate Energy saving mode. If energy saving mode is activated, the energy consumption decreases and the temperature in the device increases. The food remains fresh, but the shelf life is shortened.

Temperature zone	Recommended setting (see Setting the temperature)	Temperature with active E-Saver
-18 °C	-18 °C	-16 °C

*Temperatures*

## Activating E-Saver



Fig. 47

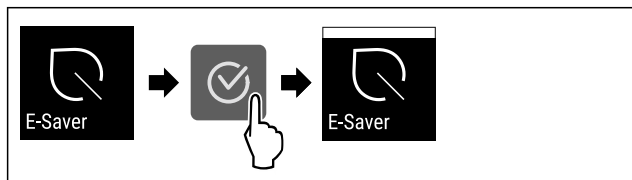

Fig. 48

- ▶ Carry out action steps according to the illustration.
- ▷ Energy saving mode is activated.

### Deactivating E-Saver



Fig. 49

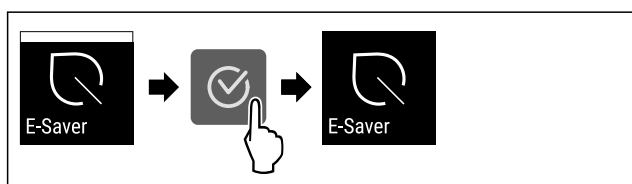

Fig. 50

- ▶ Carry out action steps according to the illustration.
- ▷ Energy saving mode is deactivated.

### Input lock

You can use this function to activate or deactivate the input lock. The input lock prevents the appliance being operated accidentally, e.g. by children.

Application:

- Avoid unintentional modification of functions.
- Avoid unintentional switching off of the device.
- Avoid unintentional temperature setting.

### Activating the input lock

If you activate the input lock, you can continue to navigate in the menus but you cannot select or change other functions.



Fig. 51

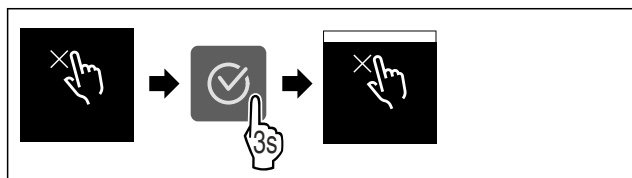

Fig. 52

- ▶ Carry out action steps according to the illustration.
- ▷ Input lock is activated.

### Deactivating the input lock



Fig. 53

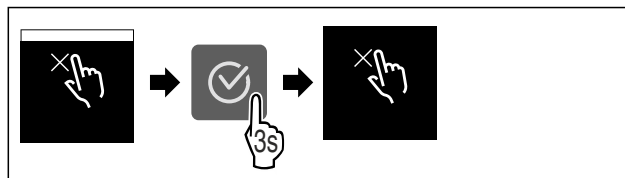

Fig. 54

- ▶ Carry out action steps according to the illustration.
- ▷ Input lock is deactivated.

### Temperature unit

Use this function to set the temperature unit. You can set degrees Celsius or degrees Fahrenheit as the temperature unit.

### Setting the temperature unit



Fig. 55

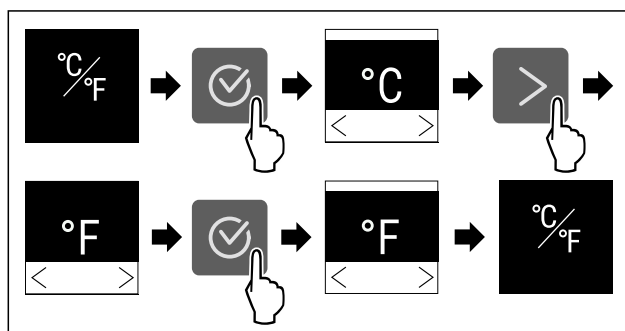

Fig. 56 Example illustration: Switch from degrees Celsius to degrees Fahrenheit.

- ▶ Carry out action steps according to the illustration.
- ▷ The temperature unit is set.

### Display brightness

Use this function to set the display brightness in stages.

You can select the following brightness levels:

- 40 %
- 60 %
- 80 %
- 100 % (pre-setting)

### Setting the brightness



Fig. 57

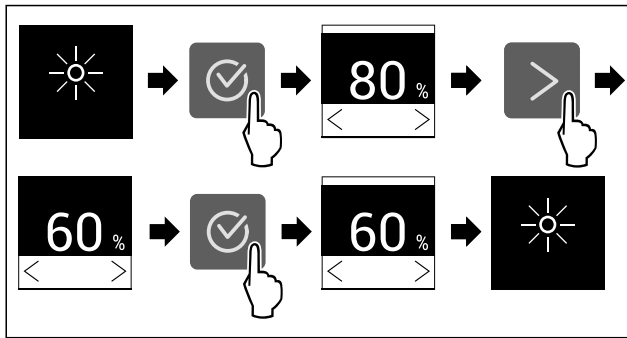

Fig. 58 Example illustration: Switch from 80 % to 60 %.

- ▶ Carry out action steps according to the illustration.
- ▷ The brightness is set.



## WiFi

Use this function to connect your appliance to WiFi. You can then operate it via the SmartDevice app on a mobile device. You can also use this function to disconnect or reset the WiFi connection.

To connect your device to WiFi, you need the SmartDeviceBox.

More information on the SmartDevice: (see 2.3 SmartDevice)

### Note

The SmartDevice function is not available in the following countries: Russia, Belarus, Kazakhstan.

You cannot use the SmartDeviceBox.

### Establishing the WiFi connection for the first time

Make sure that the following requirements are fulfilled:

- You have purchased and inserted a SmartDeviceBox. (see 2.3 SmartDevice)
- You have installed the SmartDevice app (see [apps.home.liebherr.com](https://apps.home.liebherr.com)).
- Registration in the SmartDevice app is completed.



Fig. 59

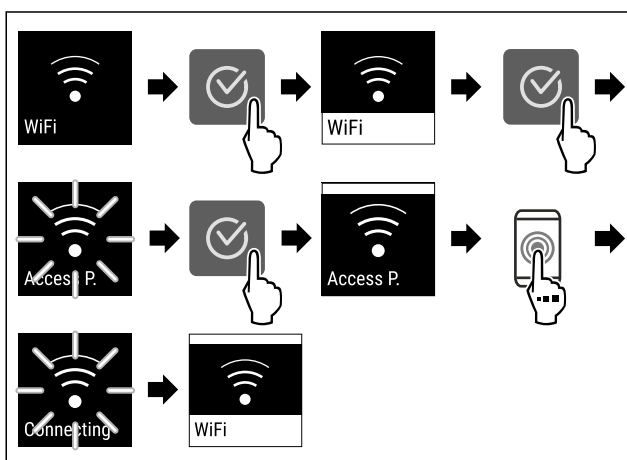

Fig. 60

- ▶ Carry out action steps according to the illustration.
- ▷ Connection is established.

### Disconnecting from the WiFi



Fig. 61

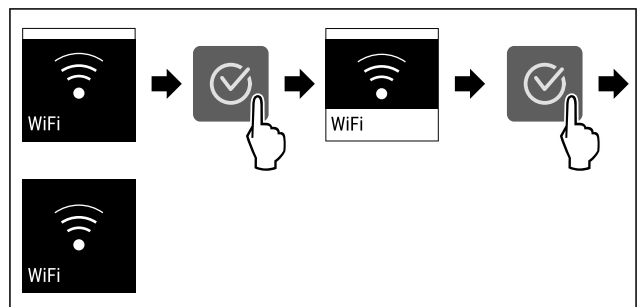

Fig. 62

- ▶ Carry out action steps according to the illustration.
- ▷ There is no connection.

### Resetting the WiFi connection

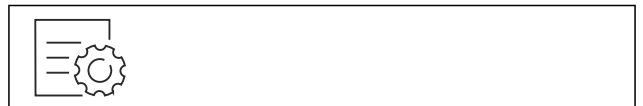

Fig. 63

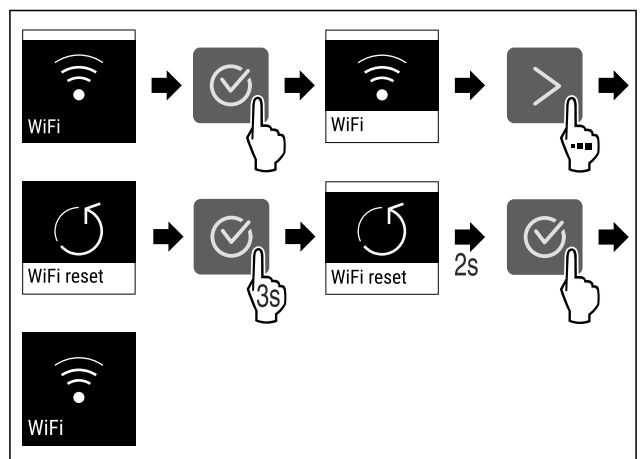

Fig. 64

- ▶ Carry out action steps according to the illustration.
- ▷ WiFi connection and other WiFi settings are reset to factory settings.

### Showing information about the WiFi connection

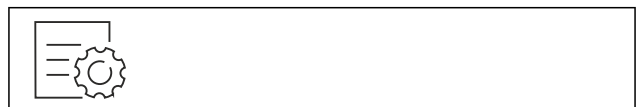

Fig. 65

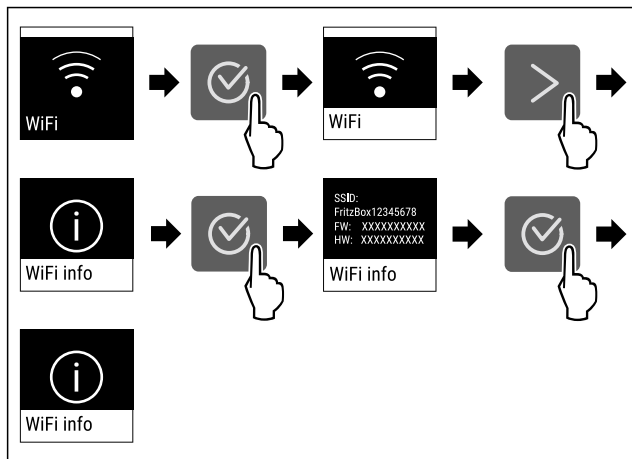

Fig. 66

- ▶ Carry out action steps according to the illustration.

## Device information

Use this function to indicate the model name, index, serial number and service number of your device. You will need the device information when you contact customer service. (see 11.4 Customer Service)

This function also opens the Advanced menu. (see 4 Functionality of the Touch display)

### Indicating the device information



Fig. 67

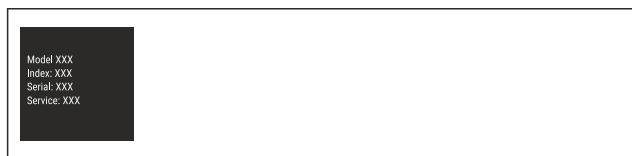

Fig. 68

- ▶ Carry out action steps according to the illustration.
- ▶ Display indicates device information.

## Software

Use this function to indicate the software version of your device.

### Indicating the software version

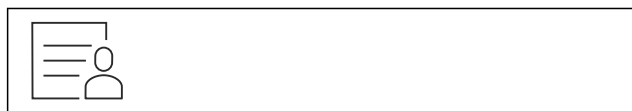

Fig. 69



Fig. 70

- ▶ Carry out action steps according to the illustration.
- ▶ Display indicates software version.

## Start defrosting cycle

Use this function to start the automatic defrosting cycle manually if it does not start automatically in the event of a fault.

### Starting defrosting cycle

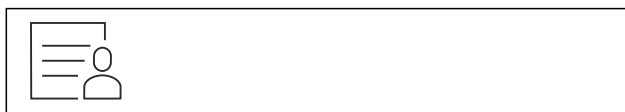

Fig. 71

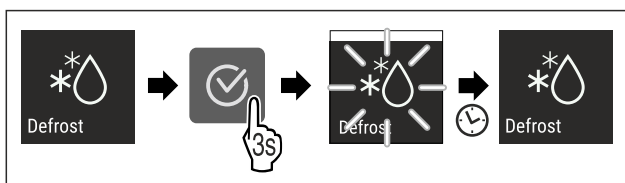

Fig. 72

- ▶ Carry out action steps according to the illustration.
- ▶ Defrosting cycle has started: Icon flashes until defrosting cycle is automatically completed.
- ▶ When defrosting cycle is finished: The device continues to run in normal mode.

### Cancelling defrosting cycle

The defrosting cycle will be stopped automatically. However, you can also cancel the defrosting cycle at any time during the defrosting process:

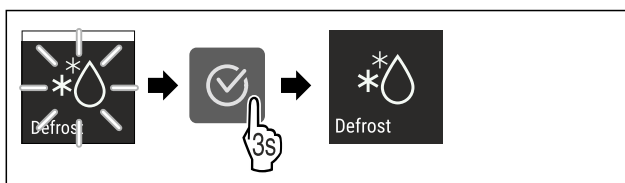

Fig. 73

- ▶ Carry out action steps according to the illustration.
- ▶ Defrosting cycle is cancelled.
- ▶ The device continues to run in normal mode.

## Door alarm

Use this function to activate or deactivate the door alarm. The door alarm sounds if the door is open for too long. The door alarm is activated on delivery. You can set how long the door may be open before the door alarm sounds.

The following values can be set:

- 1 minute
- 2 minutes
- 3 minutes
- Off

### Setting the door alarm



Fig. 74

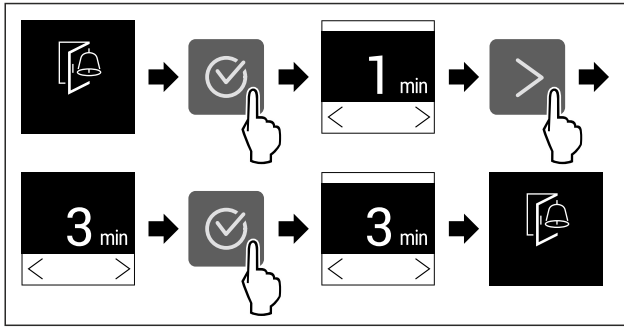

Fig. 75 Example illustration: Change door alarm from 1 minute to 3 minutes.

- ▶ Carry out action steps according to the illustration.
- ▶ The door alarm is set.

### Deactivating the door alarm



Fig. 77

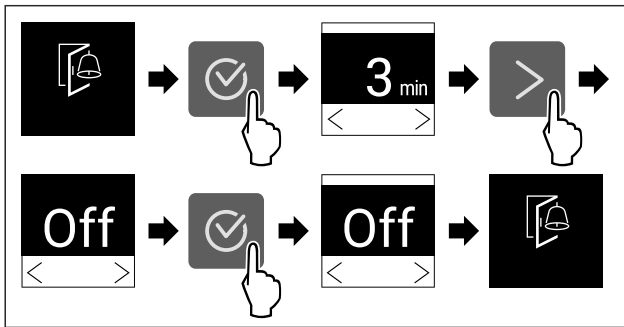

Fig. 78

- ▶ Carry out action steps according to the illustration.
- ▶ The door alarm is deactivated.

### Demo mode

Demo mode is a special feature for dealers who want to demonstrate appliance features. If you activate demo mode, all refrigeration functions are deactivated.

If you switch on your appliance and “Demo” appears in the status display, then demo mode is already activated.

If you activate and then deactivate demo mode, the appliance will be reset to factory defaults. (see Resetting to factory settings)

#### Activating demo mode



Fig. 79

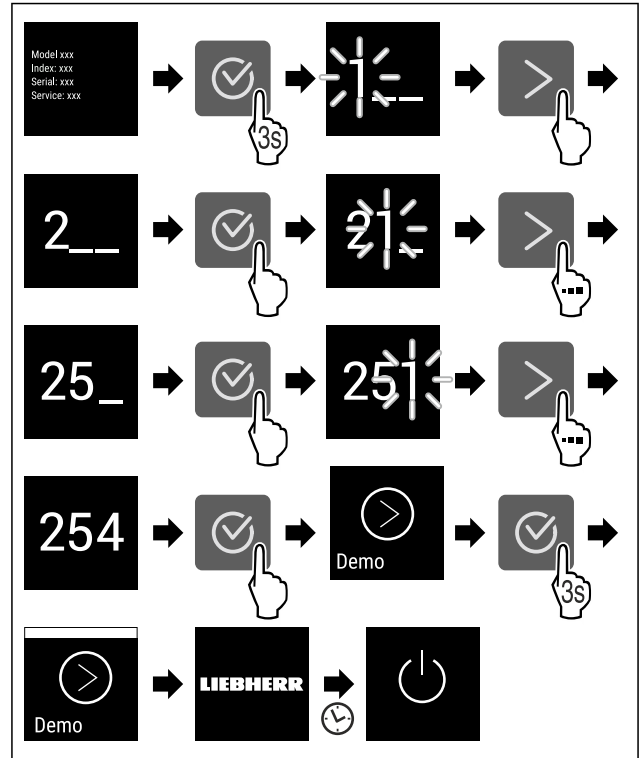

Fig. 80

- ▶ Carry out action steps according to the illustration.
- ▶ Demo mode is activated.
- ▶ Appliance is switched off.
- ▶ Switch on the appliance. (see 5.1 Switching on appliance (first use))
- ▶ “DEMO” appears in the status display.

#### Deactivating demo mode



Fig. 81

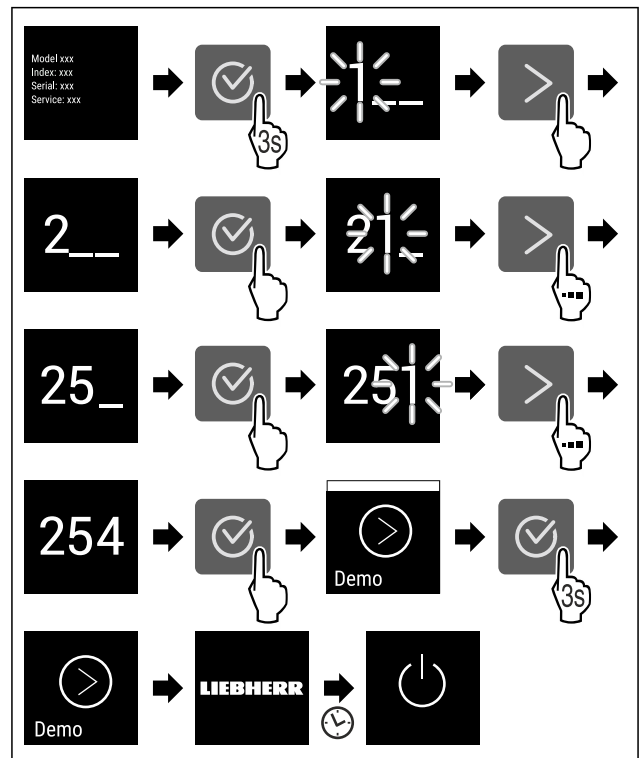

Fig. 82

- ▶ Carry out action steps according to the illustration.
- ▶ Demo mode is deactivated.
- ▶ Appliance is switched off.
- ▶ Switch on the appliance. (see 5.1 Switching on appliance (first use))
- ▶ Appliance is reset to factory settings.

## Resetting to factory settings

Use this function to reset all settings to factory defaults. All settings you have made so far are reset to their original settings.

### Performing a reset



Fig. 83

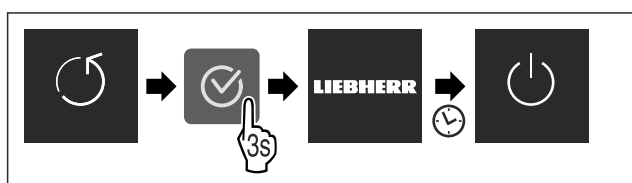

Fig. 84

- ▶ Carry out action steps according to the illustration.
- ▶ Device is reset.
- ▶ Device is switched off.
- ▶ Restart the device. (see 5.1 Switching on appliance (first use))

## 8.3 Messages

There are two categories of messages:



Category	Importance
Warning	Warnings appear in the event of a door alarm or malfunction. Simple warnings can be cancelled by yourself. In the event of serious malfunctions, you must contact customer service. (see 11.4 Customer Service)
Reminder	Reminders remind you of general processes. You can carry out these operations to end the message.

### 8.3.1 Overview of warnings

Behaviour of the appliance in the event of warnings:

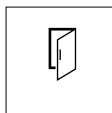
- Warning appears on the display.
- The alarm tone sounds at an ever-increasing volume.

Message	Cause	Exit message the
 <b>Door alarm</b>	The message appears if the door is open for too long.	Carry out action steps. (see Door alarm)

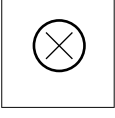
Message	Cause	Exit message the
 <b>Power outage alarm</b>	The message appears if the freezing temperature has risen due to a power failure.	Carry out action steps. (see Power outage alarm)
 <b>Temperature alarm</b>	The message appears if the freezing temperature does not correspond to the set temperature.	Carry out action steps. (see Temperature alarm)
 <b>Error</b>	The message appears if there is an appliance error. A component of the appliance has a fault.	Carry out action steps. (see Error)

### 8.3.2 Ending warnings

#### Door alarm

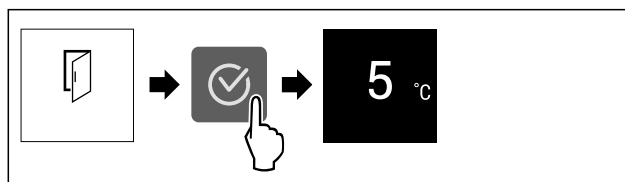

Fig. 85 Example illustration

- ▶ Carry out action steps according to the illustration.
- or-
- ▶ Close the door.

- ▶ The display returns to the status indicator.
  - ▶ The appliance cools more vigorously, which means that the temperature shown on the display may be higher than the actual temperature inside the appliance.\*
  - ▶ Appliance noises can be louder.\*
- You can set how long the door may be open before the door alarm sounds. (see Setting the door alarm)

#### Power outage alarm

When the power failure has ended, the appliance will automatically cool down to the previously set target temperature without you having to confirm the message. However, for the message to disappear from the display, you must confirm it.

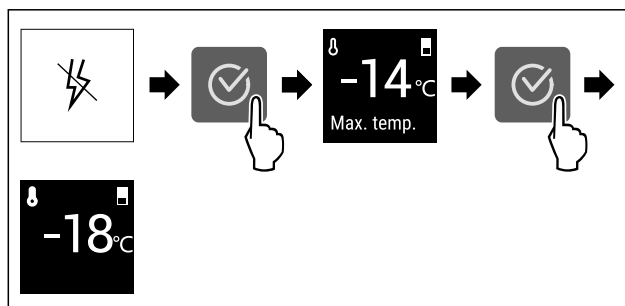

Fig. 86 Example illustration

- ▶ Press the confirmation symbol.
- ▶ Warmest freezing temperature is displayed.
- ▶ If the freezing temperature was below -9 °C: Food can still be consumed.  
If the freezing temperature has risen above -9 °C:

# Features

- ▶ Check the food.
- ▶ Press the confirmation symbol.
- ▷ The display returns to the status indicator: Current temperature and target temperature are displayed.

## Temperature alarm

Temperature differences can be caused by:

- You have put in warm, fresh food.
- Too much warm air has got in while you were sorting out the freezer or removing items.
- There has been a longer power failure.
- The appliance is faulty.
- ▶ Eliminate causes.
- ▷ The appliance cools to the target temperature set previously.

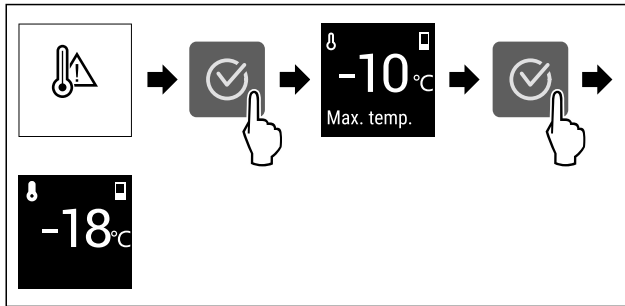

Fig. 87 Example illustration

- ▶ Press the confirmation symbol.
- ▷ Warmest freezing temperature is displayed.
- ▷ If the freezing temperature was below  $-9\text{ }^{\circ}\text{C}$ : Food can still be consumed. If the freezing temperature has risen above  $-9\text{ }^{\circ}\text{C}$ :
- ▶ Check the food.
- ▶ Press the confirmation symbol.
- ▷ The display returns to the status indicator: Current temperature and target temperature are displayed.

## Error

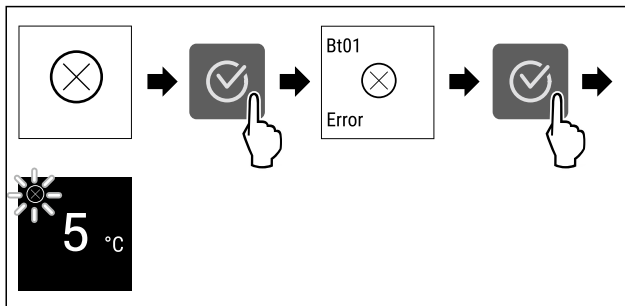

Fig. 88 Example illustration

- ▶ Press the confirmation symbol.
- ▷ Error code is displayed.
- ▶ Note the error code.
- ▶ Press the confirmation symbol.
- ▷ The display returns to the status indicator.
- ▶ Contact Customer Service. (see 11.4 Customer Service)

## 8.3.3 Overview of reminders

Behaviour of the appliance during reminders:

- Reminder appears on the display.
- Alarm tone sounds.

The following reminders can be deactivated :

# 9 Features

## 9.1 Drawers

You can remove the drawers for cleaning.

You can remove the drawers to use VarioSpace.

The way to remove/insert the drawers varies depending on the pull-out system. Your appliance can contain various pull-out systems.

### Note

The energy consumption increases and the cooling power goes down if ventilation is not sufficient.

- ▶ Leave the bottom drawer inside the appliance.
- ▶ Always keep the inside vents at the rear wall clear.

### 9.1.1 Top tilting drawer

When you pull out the top drawer, it tilts forward. This gives you a better view into the drawer. The function depends on the height of the appliance.

#### Removing drawer

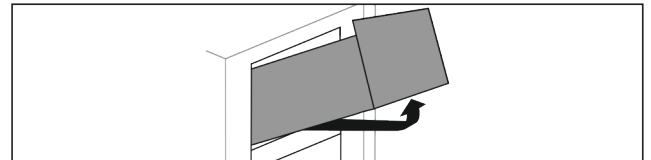

Fig. 89

- ▶ Pull out drawer as far as it will go.
- ▶ Lift drawer at the front.
- ▶ Lift drawer from below.
- ▶ Remove drawer to the front.

#### Inserting drawer

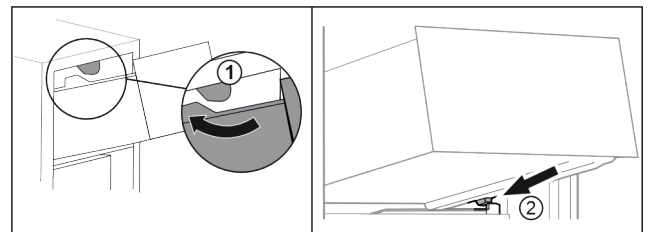

Fig. 90

- ▶ Guide drawer around the upper stoppers. Fig. 90 (1)
- ▶ Place drawer at an angle behind the lower stoppers onto moulded rib. Fig. 90 (2)
- ▶ Lower drawer.
- ▶ Slide to the back.

### 9.1.2 Drawer on moulded rib

The drawer runs directly on the moulded rib. There are no rails.

#### Removing drawer

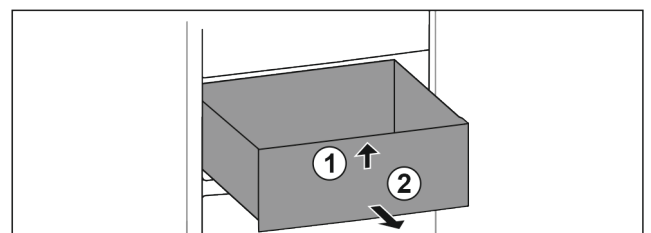

Fig. 91

- ▶ Pull out drawer as far as it will go.
- ▶ Lift up drawer at the front. Fig. 91 (1)
- ▶ Remove drawer to the front. Fig. 91 (2)

## Inserting drawer

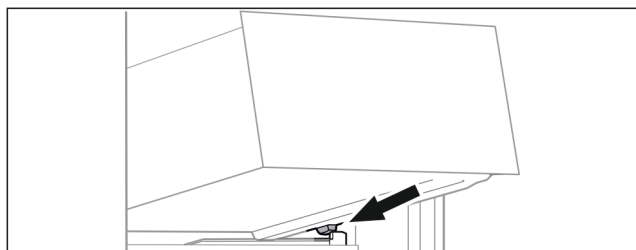

Fig. 92

- ▶ Place drawer at an angle behind the stoppers on the moulded rib. (see Fig. 92)
- ▶ Lower drawer.
- ▶ Slide in drawer to the back.

### 9.1.3 Bottom drawer

The drawer is the lowest drawer in the appliance. It runs directly on the moulded rib. There are no rails.

#### Removing drawer

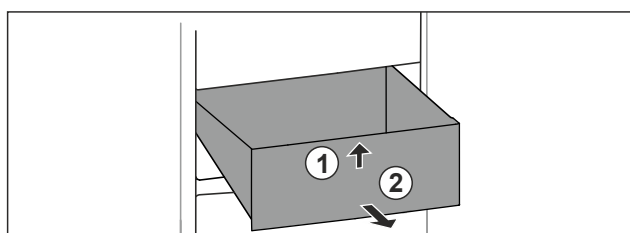

Fig. 93

- ▶ Pull out drawer as far as it will go.
- ▶ Lift up drawer at the front. Fig. 93 (1).
- ▶ Remove drawer to the front. Fig. 93 (2).

#### Inserting drawer

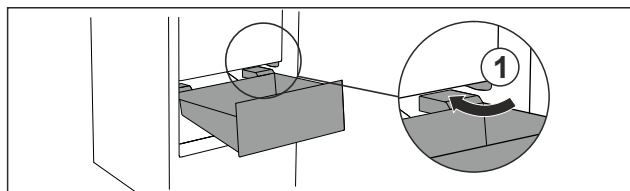

Fig. 94

- ▶ Guide drawer in at an angle around the stoppers Fig. 94 (1).
- ▶ Lower drawer.
- ▶ Slide in drawer to the back.

## 9.2 VarioSpace

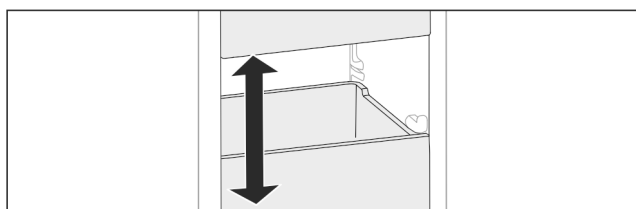

Fig. 95

You can remove drawers and glass panels from your appliance. This provides more room for large food items such as poultry, joints of meat, large game, and tall baked products. You can then freeze these items whole for later preparation.

- ▶ Note the weight limits on the drawers and glass panels (see 11.1 Technical specifications).

## 10 Maintenance

### 10.1 Disassembling / assembling pull-out systems

#### 10.1.1 Notes on disassembly

You can disassemble some of the pull-out systems for cleaning. Your appliance can contain a variety of pull-out systems.

The following pull-out systems can be disassembled or cannot be disassembled:

Pull-out system	can be disassembled / cannot be disassembled
Top tiltable drawer	cannot be disassembled
Drawer guided on container rib	can be disassembled (see 10.1.2 Drawer on moulded rib)
Bottom drawer	cannot be disassembled

#### 10.1.2 Drawer on moulded rib

##### Disassembling pull-out system

Make sure the following prerequisites are met:

- Drawer has been removed. (see 9.1.2 Drawer on moulded rib)

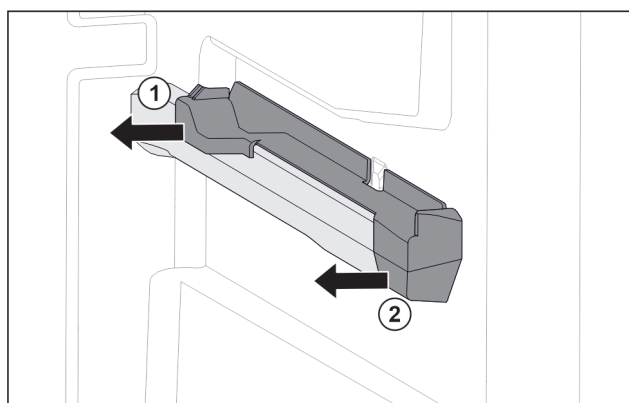

Fig. 96 Attachment on the right moulded rib

- ▶ Grab attachment at the back from below.
- ▶ Pull off attachment at the back sideways. Fig. 96 (1)
- ▶ Pull off attachment at the front sideways. Fig. 96 (2)

##### Installing pull-out system

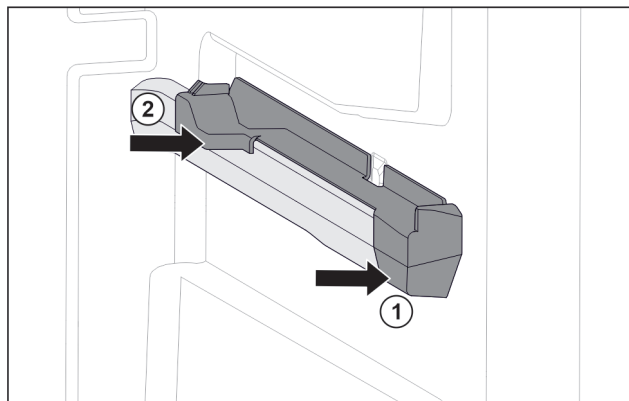

Fig. 97 Attachment on the right moulded rib

- ▶ Position attachment on moulded rib at the front. Fig. 97 (1)
- ▶ Press on attachment at the back. Fig. 97 (2)

# Customer help

## 10.2 Defrosting the appliance

### 10.2.1 Defrosting with NoFrost

Defrosting is performed automatically with the NoFrost system. The moisture is deposited on the evaporator, is periodically defrosted and evaporates.

The appliance does not have to be defrosted.

#### Note

Water droplets may collect on the bottom of the appliance. When you take the appliance out of operation:

- ▶ Place a towel in front of the appliance to catch any water droplets that escape. (see 12 Shutting down)

## 10.3 Cleaning the appliance

### 10.3.1 Ready



#### WARNING

Danger of electric shock!

- ▶ Remove the refrigerator connector or interrupt the power supply.



#### WARNING

Risk of fire

- ▶ Do not damage the refrigeration circuit.
- ▶ Empty the appliance.
- ▶ Remove mains connector.

### 10.3.2 Clean the housing

#### NOTICE

Improper cleaning!  
Damage to the appliance.

- ▶ Only use soft cleaning cloths and ph-neutral all-purpose cleaners.
- ▶ Do not use abrasive sponges or steel wool which may cause scratches.
- ▶ Do not use any sharp or abrasive cleaning agents, nor any that contain sand, chloride or acid.



#### WARNING

Risk of injury and damage as a result of hot steam!  
Hot steam can lead to burns and can damage the surfaces.

- ▶ Do not use any steam cleaners!
- ▶ Wipe the housing down with soft, clean cloth. If very dirty, use lukewarm water with a neutral cleaner. Glass surfaces can also be cleaned with glass cleaner.

### 10.3.3 Cleaning the interior

#### NOTICE

Improper cleaning!  
Damage to the appliance.

- ▶ Only use soft cleaning cloths and ph-neutral all-purpose cleaners.
- ▶ Do not use abrasive sponges or steel wool which may cause scratches.
- ▶ Do not use any sharp or abrasive cleaning agents, nor any that contain sand, chloride or acid.

- ▶ Plastic surfaces: clean by hand with a soft clean cloth, lukewarm water and a little detergent.

- ▶ Metal surfaces: clean by hand with a soft clean cloth, lukewarm water and a little detergent.

### 10.3.4 Clean the components

#### NOTICE

Improper cleaning!  
Damage to the appliance.

- ▶ Only use soft cleaning cloths and ph-neutral all-purpose cleaners.
- ▶ Do not use abrasive sponges or steel wool which may cause scratches.
- ▶ Do not use any sharp or abrasive cleaning agents, nor any that contain sand, chloride or acid.

Clean with a soft, clean cloth, lukewarm water and some detergent:

- Drawer
- Freezer tray

Wash in the dishwasher up to 60 °C:

- Ice cube tray
- ▶ To disassemble components: see the relevant section.
- ▶ Clean the components.

### 10.3.5 After cleaning

- ▶ Wipe the appliance and the components dry.
- ▶ Connect and switch on the appliance.
- ▶ Activate SuperFrost (see 8.2 Appliance functions). The temperature is cold enough:
- ▶ Place the food inside.
- ▶ Repeat cleaning regularly.

## 11 Customer help

### 11.1 Technical specifications

Temperature range	
Freeze	-28 °C to -15 °C

Maximum ice cube quantity / 24 hours	
Freezer compartment	see type plate under "Freezing capacity .../ 24 h"

Maximum loading weight for the equipment			
Equipment	Appliance width 600 mm (see installation instructions, device dimensions)	Appliance width 700 mm (see installation instructions, device dimensions)	Appliance width 750 mm (see installation instructions, device dimensions)
Drawer on container rib (see 9.1.2 Drawer on moulded rib)	19 kg	25 kg	--
Bottom drawer (see 9.1.3 Bottom drawer)	11 kg	19 kg	

Maximum loading weight for the equipment			
Equipment	Appliance width 600 mm (see installation instructions, device dimensions)	Appliance width 700 mm (see installation instructions, device dimensions)	Appliance width 750 mm (see installation instructions, device dimensions)
Top tiltable drawer (see 9.1.1 Top tilting drawer)	19 kg	19 kg	--

## 11.2 Operating noises

The appliance makes different noises when it is on.

- At **higher temperatures** the appliance uses less energy but works for longer. It is **quieter**.
- At **lower temperatures** the food is cooled faster. It is **louder**.

Examples:

- Functions on (see 8.2 Appliance functions)
- Fan running
- Food recently added
- High ambient temperature
- Door open for a while

Noise	Possible cause	Type of noise
Bubbling and splashing	Coolant flowing into the cooling circuit.	Normal operating noise
Hissing	Coolant sprays into the cooling circuit.	Normal operating noise
Humming	The appliance is cooling. The volume depends on the cooling output.	Normal operating noise

Noise	Possible cause	Type of noise
Humming and rustling	The fan is running.	Normal operating noise
Clicking	Components are switched on and off.	Normal switching noise
Rattling humming or	Valves or flaps are working.	Normal switching noise
Faint knocking, humming or buzzing*	The valve is active.	Normal operating noise

Noise	Possible cause	Type of noise	Lifting
Vibration	Improper setup	Defective noise	Level the appliance using the adjustable feet.
Rattling	Components, items inside the appliance	Defective noise	Secure components. Leave enough space between the items.

## 11.3 Technical fault

Your appliance is designed and built to ensure it works reliably and has a long service life. In the unlikely event that a fault occurs during operation, please check whether it is due to an operating error. If so, you will be charged for the callout and repair costs even if it falls within the warranty period.

You can fix the following faults yourself.

### 11.3.1 Appliance function

Defect	Cause	Remedy
<b>The appliance is not working.</b>	→ The appliance is not switched on.	▶ Switch the appliance on.
	→ The power plug is not properly plugged into the socket.	▶ Check the power plug.
	→ There is something wrong with the power outlet fuse.	▶ Check the fuse.
	→ Power cut	▶ Keep the appliance closed. ▶ Safeguarding food: Place cold packs on top of food or use another freezer if the power cut lasts longer. ▶ Do not re-freeze defrosted food,
	→ The IEC socket is not plugged into the appliance correctly.	▶ Check the IEC socket.
<b>Temperature is not cold enough.</b>	→ The appliance door is not closed properly.	▶ Close the appliance door.

Defect	Cause	Remedy
	→ The ambient temperature is too high.	▶ Problem solution: (see 1.2 Climate classes)
	→ The appliance was opened too many times or for too long.	▶ Wait to see if the required temperature corrects itself. If not, contact Customer Service. (see 11.4 Customer Service)
	→ Too much fresh food was placed inside without SuperFrost.	▶ Solution: (see SuperFrost)
	→ The temperature is set incorrectly.	▶ Turn down the temperature and check after 24 hours.
	→ The appliance is too close to a heat source (oven, radiator, etc).	▶ Move the appliance or the heat source.
<b>The temperature shown on the display is higher than the actual temperature in the appliance.*</b>	→ Appliance door was open for a long time and the door alarm was triggered automatically. This causes the appliance to cool more vigorously.	▶ Close appliance door.
<b>The door seal is defective or needs to be replaced for another reason.</b>	→ The door seal can be replaced. It can be replaced without the need for special tools.	▶ Contact Customer Service. (see 11.4 Customer Service)
<b>The appliance builds up too much ice or condensation.</b>	→ The door seal may have slipped out of its groove.	▶ Check that the door seal is well fitted in the groove.
<b>The exterior surfaces of the appliance are warm.*</b>	→ The heat of the refrigeration circuit is used to avoid condensation.	▶ This is normal.

## 11.4 Customer Service

First check whether you can rectify the fault yourself (see 11 Customer help) . If you cannot rectify the problem, contact Customer Service.

You can find the address in the enclosed brochure “Liebherr-Service” or at [home.liebherr.com/service](http://home.liebherr.com/service).



### WARNING

Unprofessional repair!  
Injuries.

- ▶ Have any repairs and action - not expressly specified - on the appliance and mains cable carried out by service personnel only. (see 10 Maintenance)
- ▶ A damaged mains cable may only be replaced by the manufacturer, the manufacturer's Customer Service or a similarly qualified person.
- ▶ In the case of appliances with an IEC connector, the change may be made by the customer.

### 11.4.1 Contacting Customer Service

Make sure that the following appliance information is available:

- Appliance name (model and index)
- Service no. (Service)
- Serial no. (S no.)
- ▶ Call up the appliance information via the display. (see Device information)

-or-

- ▶ Refer to the type plate for appliance information. (see 11.5 Model plate)
- ▶ Note down the appliance information.
- ▶ Notify customer service: Report errors and the appliance information.
- ▶ This will help us to provide you with a faster, more accurate service.
- ▶ Follow further instructions from Customer Service.

## 11.5 Model plate

The model plate is behind the drawers on the inside of the appliance.

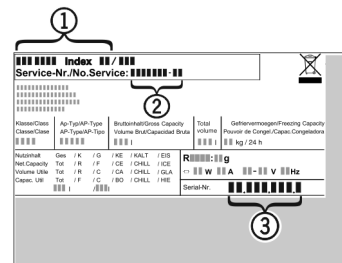

Fig. 98

- (1)** Appliance description      **(3)** Serial no.
- (2)** Service no.
- ▶ Note the data on the model plate.

## 12 Shutting down

- ▶ Empty the appliance.
- ▶ Switch off appliance. (see Switching the appliance off and on)
- ▶ Pull the mains plug out of the socket.
- ▶ Remove the IEC socket if required: Pull the IEC socket out of the appliance plug and move it to the left and right at the same time.
- ▶ Place a towel in front of the appliance to catch any drops of water that may run out.
- ▶ Clean appliance. (see 10.3 Cleaning the appliance)
- ▶ Leave the door open, so that no unpleasant odours arise.

## 13 Disposal

Ensure that the following requirements are met:

- Meaning of the symbols on the appliance: are familiar. (see 1.14 Symbols on the appliance)
- Notes on disposal are familiar. (see 1.8 Disposal)

### 13.1 Preparing the appliance for disposal

- ▶ Shutting your appliance down. (see 12 Shutting down)

### 13.2 Disposing of the appliance in an environmentally friendly manner

---



#### **WARNING**

Leaking coolant and oil!

Fire. The coolant contained in the appliance is eco-friendly, but also flammable. The oil contained in the appliance is flammable. Escaping coolant and oil can ignite if the concentration is high enough and in contact with an external heat source.

- ▶ Do not damage the pipelines of the coolant circuit and the compressor.
- 
- ▶ Observe the notes on transporting the appliance. (see 3.5 Transporting the appliance)
  - ▶ Remove the appliance without damaging it.
  - ▶ Dispose of appliance according to specifications.

Scan QR Code and find  
digital operating and  
installation instructions.

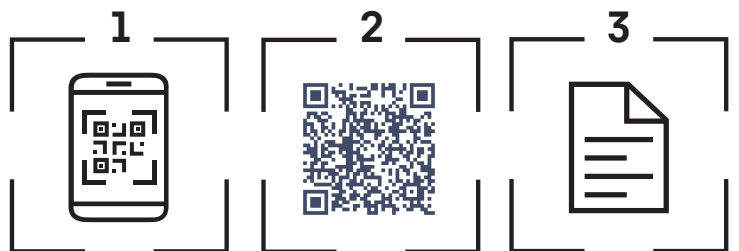

[home.liebherr.com](https://home.liebherr.com)

20260217

**7088645-00**

---

**Liebherr-Hausgeräte GmbH**  
Memminger Straße 77-79  
88416 Ochsenhausen  
Deutschland