



User Guide

Quality, Design and Innovation









home.liebherr.com/fridge-manuals









LIEBHERR

Contents

1	Safety information and warnings.....	3
1.1	Intended use.....	3
1.2	Climate classes.....	3
1.3	User group.....	3
1.4	Installation and commissioning.....	3
1.5	Safe handling of the appliance.....	3
1.6	Cleaning.....	3
1.7	Faults, damage and repairs.....	4
1.8	Disposal.....	4
1.9	Conformity.....	4
1.10	Open source licences.....	4
1.11	Spare parts.....	4
1.12	Symbols on the appliance.....	4
1.13	Warning levels.....	4
2	Appliance at a glance.....	4
2.1	Scope of delivery.....	4
2.2	Overview of the appliance and equipment.....	5
3	Functionality of the display.....	5
3.1	Navigation by touchbutton and symbol explanation.....	5
3.2	Menus.....	5
4	Putting into operation.....	6
4.1	Switching on device (first use).....	6
5	Storage.....	7
5.1	Information regarding storage.....	7
5.2	Fridge compartment.....	7
5.3	****-freezer compartment*.....	7
5.4	Storage times.....	7
6	Saving energy.....	8
7	Controls.....	8
7.1	Operating controls and display elements.....	8
7.1.1	Temperature display/Status indicator.....	8
7.1.2	LED behaviour.....	8
7.1.3	Audible signals.....	9
7.2	Appliance functions.....	9
7.2.1	Notes on the appliance functions.....	9
	Switching the appliance off and on.....	9
	Temperature.....	9
	SuperCool.....	9
	SabbathMode.....	10
	Input lock.....	10
	Demo mode.....	11
	Resetting to factory settings.....	11
7.3	Messages.....	11
7.3.1	Ending messages.....	11
8	Features.....	12
8.1	4-star freezer compartment*.....	12
8.2	Door rack.....	12
8.3	Drawers.....	12
8.4	Bottle holder.....	13
9	Maintenance.....	13
9.1	FreshAir carbon filter*.....	13
9.2	Removing the bottle holder.....	13
9.3	Inserting the bottle holder.....	13
9.4	Disassembling / assembling pull-out systems.....	14
9.5	Defrosting the appliance.....	14

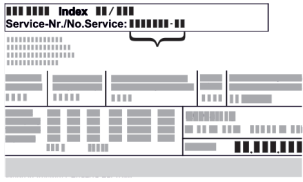
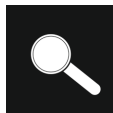
9.6	Defrosting the freezer compartment manually*.....	14
9.7	Cleaning the appliance.....	14
10	Customer help.....	15
10.1	Technical specifications.....	15
10.2	Operating noises.....	15
10.3	Technical fault.....	15
10.4	Customer Service.....	16
10.5	Model plate.....	16
11	Shutting down.....	17
12	Disposal.....	17
12.1	Preparing the appliance for disposal.....	17
12.2	Disposing of the appliance in an environmentally friendly manner.....	17

The manufacturer is continually working on the further development of all types and models. Please be aware that we reserve the right to make changes to the shape, equipment and technology.

Symbol	Explanation
	Read instructions Please read the information in these instructions carefully to understand all of the benefits of your new appliance.
	Additional information on the Internet The digital manual with additional information and in other languages can be found via the QR code on the front of the manual or by entering the service number at home.liebherr.com/fridge-manuals . The service number can be found on the serial tag:  <i>Fig. Example illustration</i>
	Check appliance Check all parts for transport damage. If you have any complaints, please contact your agent or customer service.
	Differences These instructions apply to a range of models, so differences are possible. Sections that apply to certain models only are marked with an asterisk (*).
	Instructions and results Instructions are marked with a ▶. Results are marked with a ▷.
	Videos Videos about the appliances are available on the YouTube channels of Liebherr-Hausgeräte.

Open source licences:

The appliance contains software components that use open source licences. Information on the open source licences used can be found here: home.liebherr.com/open-source-licences

These operating instructions apply to:

DURd	3600 3601
URc	3700 3701
URd	3600 3601

1 Safety information and warnings

Keep this user information in a safe place so that you can refer to it at any time.

If you pass on the appliance, pass this user information on to subsequent owners.

To use the appliance properly and safely, read this user information carefully before installation and use. Always follow the instructions, safety instructions and warnings contained therein. They are important so that you can install and operate the appliance safely and properly.

1.1 Intended use

- This appliance is intended for household use and similar applications such as:
 - in staff kitchen areas in shops, offices and other work areas
 - in agricultural environments and by guests in hotels, motels and other accommodation
 - in bed and breakfasts
 - in catering and similar wholesale operations
- Further uses:
 - This appliance is not suitable for freezing food.*
 - This appliance is suitable for integrated under-counter installation.
 - All other types of application are impermissible.

1.2 Climate classes

Depending on its climate class, the appliance is designed for operation within certain ambient temperature limits. The climate class for your appliance is printed on the type plate.

Note

- ▶ In order to guarantee fault-free operation comply with the specified ambient temperatures.

Climate class	for ambient temperatures from
SN	10 °C to 32 °C
N	16 °C to 32 °C
ST	16 °C to 38 °C
T	16 °C to 43 °C
SN-ST	10 °C to 38 °C
SN-T	10 °C to 43 °C

1.3 User group

- This appliance can be used by children aged from 8 years and above and persons with reduced physical, sensory or mental capabilities or lack of experience and knowledge if they have been given supervision or instruction concerning use of the appliance in a safe way and understand the hazards involved.
- Children must not play with the appliance.

- Children must not carry out cleaning and user maintenance without supervision.
- Children aged from 3 to 8 years are allowed to load and unload refrigerating appliances.

1.4 Installation and commissioning

- Only install and connect the appliance in accordance with the instructions in the user information.
- Install the appliance according to the instructions in the user information to prevent the appliance from tipping over.
- Do not close the ventilation openings in the appliance housing or in the installation housing.
- Do not damage the mains cable. The appliance must not be operated with a defective mains cable.
- Do not place portable multiple sockets or power supply units at the rear of the appliance.
- It must be easy to access the socket so that the appliance can be quickly disconnected from the power supply in case of an emergency. It must not be behind the appliance.

Appliances with anti-tip protection:

- Secure the appliance with an anti-tip device in accordance with the instructions in the user information to prevent the appliance from tipping over.

1.5 Safe handling of the appliance

- Do not store any explosive substances, such as aerosol containers with flammable propellant gas, in the appliance. These types of aerosol can be identified by the list of contents printed on it, or by a flame symbol. Any leaking gas may ignite due to electrical parts.
- Keep burning candles, lamps and other objects with naked flames away from the appliance, so that these do not set fire to the appliance.
- Alcoholic beverages and other containers bearing alcohol must be sealed tight for storage. Any leaking alcohol may ignite due to electrical parts.
- Avoid prolonged skin contact with cold surfaces or with cold/frozen food. Use gloves for protection, for example.
- The refrigerant contained (information on the type plate) is environmentally friendly but flammable. Leaking refrigerant may ignite.
 - Do not damage the refrigeration circuit.
 - Do not use any ignition sources inside the appliance.
 - Do not use electrical appliances inside the appliance (e.g. steam cleaners, heaters).
 - If the refrigerant leaks: remove any naked flames or ignition sources from the vicinity of the leakage point. Properly air the room. Inform customer service.
- Only open the door for a short time. This prevents the temperature inside the appliance from rising.
- Do not reach between the door and the appliance when opening and closing. Fingers may become trapped.
- The temperature in the warmest part of the appliance may be higher than the set temperature.

1.6 Cleaning

- Regularly clean surfaces that come into contact with food.
- Clean the defrost water drain regularly.
- Do not use an electric heater or steam cleaner, naked flames or defrost spray to speed up the defrosting process.
- Do not remove the ice with sharp objects.

Appliance at a glance

1.7 Faults, damage and repairs

- If the mains connection cable of the appliance is damaged, replace the mains connection cable.
- Repairs and interventions on the appliance may only be carried out by the customer service or by other qualified personnel trained for this purpose.
- In the event of malfunctions and appliance faults, pull out the mains plug or switch off the fuse. Always hold the plug when pulling out the mains plug. Never tug on the cable.

1.8 Disposal

- The appliance contains valuable materials and is marked with the appropriate symbol. (see 1.12 Symbols on the appliance)
 - Do not dispose of the appliance in the household waste.
 - Dispose of the appliance free of charge at your local recycling centre using the Class 1 collection containers.
 - When purchasing a new appliance, return the old appliance to the retailer free of charge.
 - Provide information about return options.
- The appliance contains refrigerant (information on the type plate) and oil. The refrigerant inside the appliance is environmentally friendly, but flammable. The oil it contains is also flammable. Escaping refrigerant and oil can ignite in high concentrations and in contact with an external heat source.
 - Do not damage the refrigeration circuit.
 - Only dispose of the appliance in accordance with the instructions in the user information.

1.9 Conformity

The coolant circuit has been tested for leak-tightness. When installed, the appliance complies with the relevant safety regulations and directives.

The full text of the EU Declaration of Conformity is available at the following web address: www.liebherr.com

1.10 Open source licences

- The appliance contains software components that use open source licences. Information on the open source licences used can be found here: home.liebherr.com/open-source-licences

1.11 Spare parts

- The spare parts availability for functional parts and stockable parts of the equipment is 15 years.

1.12 Symbols on the appliance



This symbol may be found on the compressor. It pertains to the oil in the compressor and indicates the following danger: Can be fatal if swallowed or with penetration of the respiratory tract. This information is only significant for recycling. No risk exists with normal use. Do not remove this symbol.



Warning: Fire hazard due to flammable substances. This symbol is located on the compressor and can also be found in other places on the appliance. This symbol warns of flammable substances. Do not remove this symbol.



This or a similar symbol may be on the rear of the appliance. It indicates that there are vacuum insulation panels (VIP) or perlite panels in the door and/or housing. This information is only significant for recycling. Do not remove this symbol.



This symbol is located on the type plate. It indicates that the appliance contains valuable materials and that you must not dispose of it with household waste. (see 1.8 Disposal)

1.13 Warning levels

DANGER	Identifies an immediately dangerous situation that will result in death or serious bodily injuries if it is not prevented.
WARNING	Identifies a dangerous situation that could result in death or serious bodily injury if it is not prevented.
CAUTION	Identifies an immediately dangerous situation that could result in slight or moderate injuries if it is not prevented.
ATTENTION	Identifies a hazardous situation that could result in property damage if it is not prevented.
Note	Identifies useful information and tips.

2 Appliance at a glance

2.1 Scope of delivery

Check all parts for transport damage. Contact your dealer or customer service in the event of complaints. (see 10.4 Customer Service)

Your new appliance comes with the following parts:

- Built-in appliance
- Features (depending on the model)
- Installation materials (depending on the model)
- "Quick Start Guide"
- "Installation Guide"
- "Installation Guide"*

2.2 Overview of the appliance and equipment

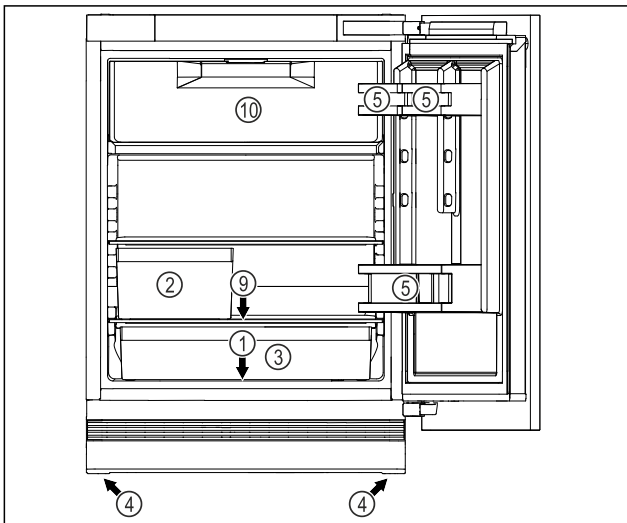

Fig. 1 Example illustration, front end

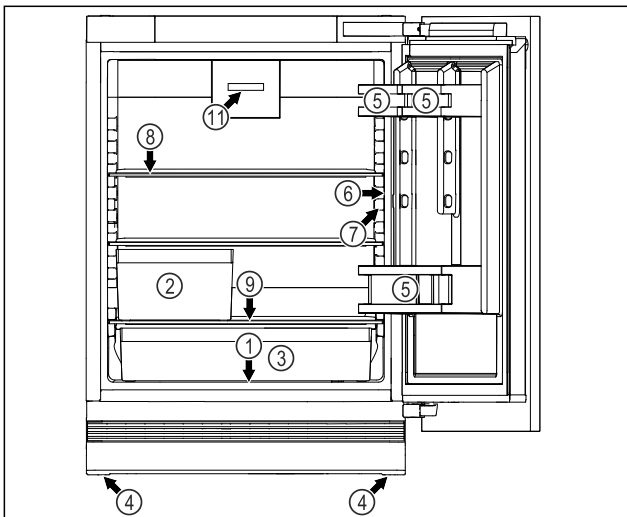

Fig. 1 Example illustration, front end

Equipment

- | | |
|--------------------------------------|---|
| (1) Type plate | (7) Interior lighting |
| (2) Fruit and vegetable box | (8) Shelf |
| (3) Universal box | (9) Defrost water drain |
| (4) Adjustable foot | (10) 4-star freezer compartment* |
| (5) Door racks | (11) Fan with FreshAir activated charcoal filter* |
| (6) Controls and temperature display | |

3 Functionality of the display

You operate your device with the touchbutton.

3.1 Navigation by touchbutton and symbol explanation

In the illustrations, different symbols are used to navigate the display by touchbutton. The following table describes these symbols.

Symbol	Description
	Touch the touchbutton with your finger briefly: Navigate through main menu and submenu. If a number is shown on the hand: The number tells you how many times you have to touch the touchbutton briefly in succession to navigate to a particular function.
	Touch the touchbutton with your finger for 3 seconds: Switch on the device. In the main menu: Switch off the device. In the submenu: Switch to the main menu. Deactivate active function of the submenu.
	Touch the touchbutton with your finger for 7 seconds: In the main menu: Open the submenu.
	Arrow with clock: It takes more than 10 seconds for the following message to appear in the display.
	Arrow with a time indication: It takes the specified amount of time until the following message appears in the display.

3.2 Menus

The device functions can be found in various menus.



Menu	Description
Main menu	When you switch the device on, you are automatically in the main menu. From here, navigate to device functions and the submenu.
Submenu	The submenu contains additional device functions for setting up your device.

3.2.1 Main menu

In the main menu, it is possible to activate/deactivate the following functions:

LED	Description
	SuperCool
	Temperature 3 °C
	Temperature 5 °C

Putting into operation

LED	Description
	Temperature 7 °C
	Temperature 9 °C

Meaning of the LEDs in the main menu

3.2.1 Opening the submenu

When you switch the device on, you are automatically in the main menu.

If you are in the submenu and want to switch to the main menu:

- ▶ Carry out action steps (see 3.2.2 Exiting the submenu) .

3.2.1 Navigating in the main menu

If you navigate in the main menu, LED 5 is followed by LED 1 again.



Fig. 2

- ▶ Touch the touchbutton briefly until the LED of the desired function lights up.
- ▶ Function is activated.

3.2.1 Sleep mode of the display

If you do not touch the touchbutton in the main menu for 10 seconds, the display switches to sleep mode. Sleep mode prevents you from adjusting the temperature by accidentally touching the touchbutton.

Ending sleep mode:

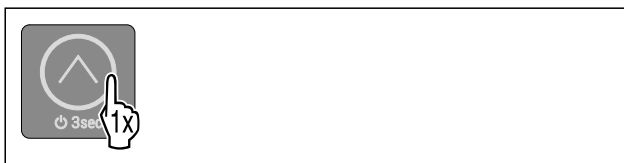





Fig. 3

- ▶ Briefly touch the touchbutton.
- ▶ Confirmation tone sounds.
- ▶ Set temperature flashes once.
- ▶ Sleep mode is ended.

3.2.2 Submenu

In the submenu, the following functions can be activated/deactivated:

LED	Description	LED position
	Input lock	LED 1

LED	Description	LED position
	SabbathMode	LED 2
	Resetting to factory settings	LED 3

Meaning of the LEDs in the submenu

3.2.2 Opening submenu



Fig. 4

- ▶ Carry out the steps as shown in the illustration until you hear a double confirmation tone after 7 seconds.
- ▶ LEDs 1-5 light up: You are in the submenu.
- ▶ If you do not perform any action on the display for 5 seconds, the display returns to the main menu.

3.2.2 Exiting the submenu



Fig. 5

- ▶ Carry out action steps according to the illustration.
- or-
- ▶ Do not touch the touchbutton for 5 seconds.
- ▶ You are in the main menu.

3.2.2 Navigating in the submenu

If you navigate in the submenu, LED 1 follows the LED of the last function in the submenu.



Fig. 6

- ▶ Touch the touchbutton briefly until the LED of the desired function lights up.
- ▶ After 5 seconds without interaction, selected function is automatically activated.

4 Putting into operation

4.1 Switching on device (first use)

Make sure that the following requirements are fulfilled:

- The device is properly installed and connected according to the installation instructions.
- All adhesive strips, adhesive and protective films and transport locks are removed from inside and on the device.

- ❑ All marketing leaflets are removed from the drawers.
- ❑ You are familiar with the functionality of the display. (see 3 Functionality of the display)

Switching on the device:

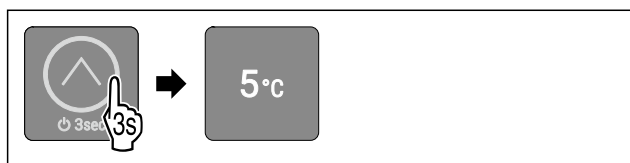

Fig. 7

- ▶ Touch the touchbutton as shown in the illustration for 3 seconds until you hear the confirmation tone.
- ▶ The device is switched on.
- ▶ Interior lighting is activated.
- ▶ LED 3 lights up: Temperature is set to 5 °C at the factory.
- ▶ The device cools to the target temperature set at the factory.

Device starts in demo mode:

When the device starts in demo mode:

- ▶ Deactivating demo mode. (see Deactivating demo mode)

Display switches to sleep mode:

When the display switches to sleep mode:

- ▶ Briefly touch the touchbutton. (see 3.2.1 Sleep mode of the display)

Note

The manufacturer recommends:

- ▶ Stock with food: Wait for around 6 hours until the set temperature is reached.
- ▶ **Store frozen foods** at -18 °C or colder.*
- ▶ Observe the notes on storing food. (see 5.1 Information regarding storage)

Note

Accessories can be purchased from the Liebherr-Hausgeräte store at home.liebherr.com/shop/de/deu/zubehor.html.

5 Storage

5.1 Information regarding storage



WARNING

Fire hazard from electrical appliances!

If you use electrical appliances in the food area of your appliance, they can cause a fire.

- ▶ Do not use electrical appliances in the food area of the appliance unless recommended by the manufacturer.

Note

The energy consumption increases and the cooling power goes down if ventilation is not sufficient.

- ▶ Always keep air slots clear.

Observe the following specifications for storage:

- Keep the air vents on the fan free.*
- In the freezer compartment: Package food properly.*
- Package or cover foods that readily take on or give off odours or taste in closed containers.
- Package raw meat or fish in clean, closed containers. This will prevent meat or fish from touching or dripping onto other food.
- Keep liquids in closed containers.
- Leave space between goods to ensure good air circulation.

- Store food according to the instructions on the packaging.
- Always observe the best-before date indicated on the packaging.

Note

Failure to follow these guidelines can lead to foodstuffs spoiling.

5.2 Fridge compartment

5.2.1 Arranging your food properly

- ▶ Upper area and door: Store butter, cheese, tinned food and tubes.
- ▶ Bottom shelf: Store particularly perishable foods such as ready meals, fish, meat and sausage products.
- ▶ Universal box: Store small jars, tubes, chocolate, eggs, packaged fruit and vegetables.

5.3 ****-freezer compartment*

Here, a dry, frosty storage climate is created at -18 °C. The frosty storage climate is suitable for storing frozen food for several months, for making ice cubes or freezing fresh food.

The air temperature in the freezer compartment, measured with a thermometer or other measuring device, may fluctuate. Temperature fluctuations are greater in a half-full or empty freezer and it is possible to attain temperatures warmer than -18 °C.

5.3.1 Freezing food

The maximum amount of fresh food that you can freeze within 24 hours is specified on the type plate (see 10.5 Model plate) under "Freezing capacity ... kg/24h".

To ensure that food quickly freezes through, adhere to the following quantities per package:

- Fruit and vegetables up to 1 kg
- Meat up to 2.5 kg

Arranging your food properly



CAUTION

Risk of injury due to broken glass!

Bottles and cans containing drinks may burst when being frozen. This applies particularly to sparkling drinks.

- ▶ Do not freeze bottles and cans containing drinks!

- ▶ Place packaged food in the freezer compartment.

Defrosting food



WARNING

Risk of food poisoning!

- ▶ Do not re-freeze thawed food.
- ▶ Use defrosted foodstuff as soon as possible.

You can defrost food in several ways:

- In the fridge compartment
- In the microwave
- In the oven/fan-assisted oven
- At room temperature
- ▶ Take out only as much food as necessary.

5.4 Storage times

Refer to the specified storage times as a guide.

Saving energy

In the case of foods with a minimum shelf life, the date indicated on the packaging still applies.

5.4.1 Fridge section

Always follow the best-before date stated on the packaging.

5.4.2 Freezer compartment*

Recommended shelf-lives for various types of food		
Ice cream	at -18 °C	2 to 6 months
Cold cuts, ham	at -18 °C	2 to 3 months
Bread, baked goods	at -18 °C	2 to 6 months
Game, pork	at -18 °C	6 to 9 months
Fatty fish	at -18 °C	2 to 6 months
Lean fish	at -18 °C	6 to 8 months
Cheese	at -18 °C	2 to 6 months
Poultry, beef	at -18 °C	6 to 12 months
Vegetables, fruit	at -18 °C	6 to 12 months

6 Saving energy

- Pay attention to good ventilation. Do not cover ventilation holes or grids.
- Always keep the fan air slits clear.*
- Do not install the appliance in direct sunlight or near radiators or similar sources of heat.
- If the appliance is installed directly next to an oven, the energy consumption may increase slightly. This is dependent on the service life and usage intensity of the oven.
- Energy consumption depends on the installation conditions, e.g. the ambient temperature. A warmer ambient temperature can increase the energy consumption.
- Open the appliance for as short a time as possible.
- The lower the temperature is set the higher the energy consumption.
- Only take food out for as long as necessary so that it doesn't warm up too much.
- Inserting warm food: allow to cool down to room temperature first.
- Thaw frozen food in the refrigerator.*
- If there is a thick layer of frost in the appliance: defrost the appliance.*

7 Controls

7.1 Operating controls and display elements

The display provides a quick overview of the current status of the appliance, the temperature setting, the status of functions and messages.

You operate your appliance with the touchbutton.

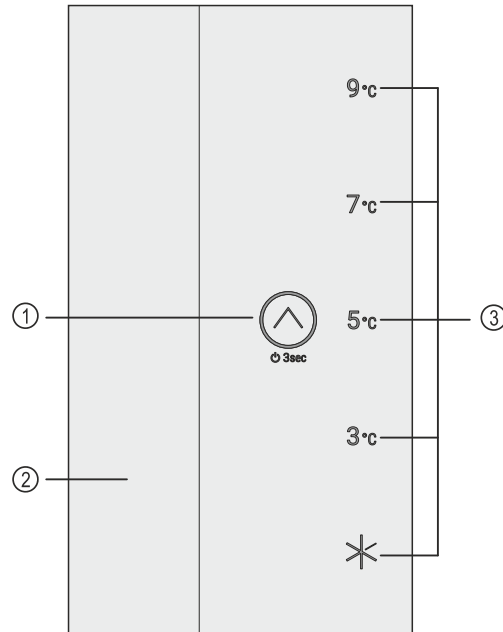

Fig. 8 Example illustration: Display

- (1) Touchbutton (operating control)
- (2) Interior lighting
- (3) Temperature display/Status indicator

7.1.1 Temperature display/Status indicator

The temperature display/status indicator consists of five LEDs:

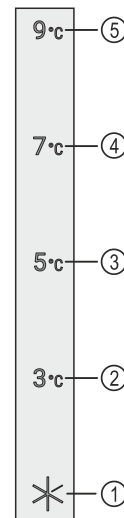



Fig. 9 Example illustration

- (1) LED 1
- (2) LED 2
- (3) LED 3
- (4) LED 4
- (5) LED 5

The LEDs indicate temperature settings (see 3.2.1 Main menu) in the main menu and functions in the submenu (see 3.2.2 Submenu).

7.1.2 LED behaviour

You can recognise the status of the device by the light up or flashing of the LEDs:

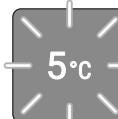
LED behaviour (example illustration)	Description
	LED does not light up: LED is not selected. Function is not active.
	LED lights up: LED is selected or function is active.
	Several LEDs flash simultaneously: An error has occurred. (see 7.3 Messages)

LED behaviour

7.1.3 Audible signals

An audible signal sounds in the following cases:

Audible signal	Description
Confirmation tone	Sounds when the touchbutton is touched.
Alarm tone	Sounds when an error occurs. (see 7.3 Messages)
Error tone	Sounds when the touchbutton is touched, but the interaction is not possible.

7.2 Appliance functions

7.2.1 Notes on the appliance functions

The appliance functions are set at the factory so that your appliance is fully functional.

Before you alter, activate or deactivate the device functions, make sure that the following requirements are met:

- You have read and understood the descriptions of how the display works. (see 3 Functionality of the display)
- You have familiarised yourself with the operating and display elements of your appliance. (see 7.1 Operating controls and display elements)

Switching the appliance off and on

Use this function to switch the entire appliance off and on.

Switching off the device

When you switch the appliance off, then the previously saved settings are saved.

Make sure that the following requirements are fulfilled:

- Handling instructions (see 11 Shutting down) are carried out.
- You are in the main menu. (see 3.2.2 Exiting the submenu)



Fig. 10

- ▶ Carry out the action steps according to the illustration until you hear the confirmation tone.

- ▶ LEDs of the display no longer light up.
- ▶ Interior lighting is deactivated.
- ▶ Device is switched off.

Switching on the device

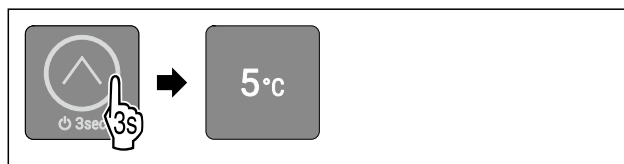

Fig. 14 Example illustration: On appliances without a SmartModule

- ▶ Carry out the action steps according to the illustration until you hear the confirmation tone.
- ▶ The device is switched on.
- ▶ Interior lighting is activated.
- ▶ During first use: The appliance cools to the target temperature set at the factory.
- ▶ If the device has been in operation before: The appliance cools to the target temperature set previously.

Temperature

Use this function to set the temperature.

The temperature depends on the following factors:

- Frequency of door opening
- Duration of door opening
- Room temperature of the installation site
- Type, temperature and quantity of food

Recommended setting: 4 °C

Setting the temperature

The function is located in the main menu on the positions of LEDs 2-5.

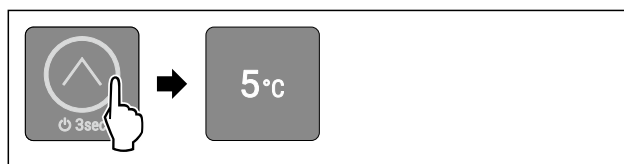

Fig. 16 Example illustration

- ▶ Briefly touch the touchbutton as shown until the desired temperature lights up.
- ▶ Temperature is set.
- ▶ The device cools to the target temperature set.

SuperCool

You can use this function to activate or deactivate SuperCool. If SuperCool is activated, then the appliance increases the cooling capacity. It allows you to achieve lower cooling temperatures. You can activate SuperCool when you would like to cool a large quantity of food quickly.

If SuperCool is activated, then lower temperatures are reached in the **** freezer compartment. You can activate SuperCool when you would like to freeze food in the **** freezer compartment.*

Activating SuperCool

The function is located in the main menu at the position of LED 1.

Time for activation of the function:

- When you would like to store fresh food in the fridge section: Activate the function when inserting food.

Controls

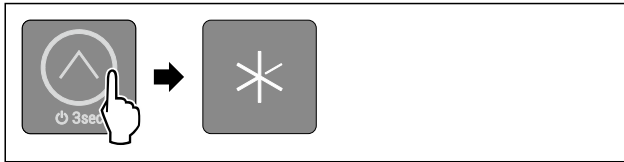

Fig. 17

- ▶ Briefly touch the touchbutton as shown until LED 1 lights up.
- ▷ LED 1 lights up: SuperCool is activated.
- ▷ The device cools to the target temperature.

Deactivating SuperCool

SuperCool is deactivated automatically after 18 hours.

However, you can also deactivate SuperCool manually at any time by setting a temperature:

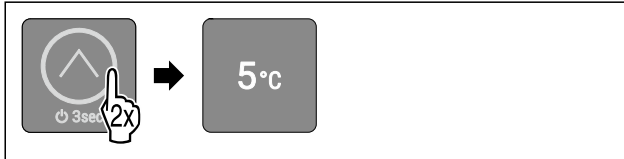

Fig. 18 Example illustration

- ▶ Briefly touch the touchbutton as shown until the desired temperature lights up.
- ▷ Temperature is set and SuperCool is deactivated.
- ▷ The appliance continues to run in normal mode.
- ▷ The device cools to the target temperature set.



SabbathMode

With this function you activate or deactivate the SabbathMode. If you activate this function, some electronic functions are switched off. As a result, your device meets the religious requirements for Jewish holidays such as Sabbath and complies with STAR-K Kosher certification.

Device status when SabbathMode is active
LEDs 1-5 light up.
All functions in the display are locked except for the Deactivating SabbathMode function .
Active functions remain active.
The interior lighting is deactivated.
Messages are not displayed.
There is no door alarm.
After a power failure, the device returns to SabbathMode.

Device status

Note

This appliance has certification from the "Institute for Science and Halacha". (www.machonhalacha.co.il)

You can find a list of STAR-K-certified appliances at www.star-k.org/appliances.

Activating SabbathMode



WARNING

Danger of food poisoning from spoiled food!

If you have SabbathMode activated and a power failure occurs, no message appears in the status display about the power failure. Once the power is restored, the appliance continues to operate in SabbathMode. The power failure may mean that food spoils and the consumption of this food could lead to food poisoning.

After a power failure:

- ▶ Do not consume food that was frozen and has thawed out.

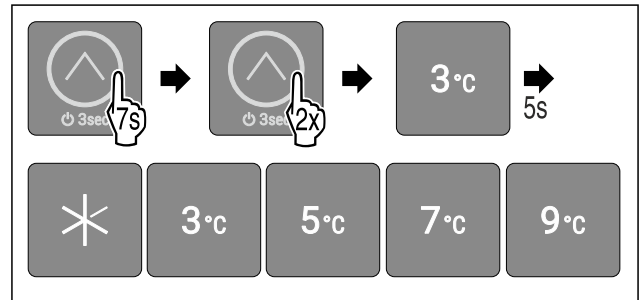

Fig. 19

- ▶ Carry out action steps according to the illustration.
- ▷ LED 2 lights up.
- ▷ After 5 seconds without interaction, SabbathMode is activated. LEDs 1-5 light up.

Deactivating SabbathMode

The SabbathMode is automatically deactivated after 80 hours. However, you can also deactivate SabbathMode manually at any time:

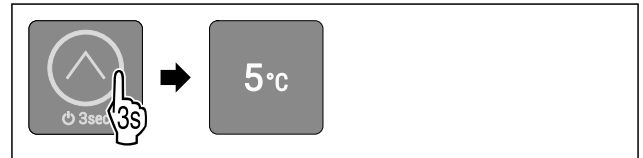

Fig. 20 Example illustration depending on the previously set temperature

- ▶ Carry out the action steps according to the illustration until you hear the confirmation tone.
- ▷ SabbathMode is deactivated.
- ▷ Interior lighting is activated.
- ▷ The device continues to run in normal mode. LED of the previously set temperature lights up.
- ▷ You are in the main menu.



Input lock

You can use this function to activate or deactivate the input lock. The input lock prevents the appliance being operated accidentally, e. g. by children.

Application:

- Avoid unintentional modification of functions.
- Avoid unintentional switching off of the device.
- Avoid unintentional temperature setting.

Activating the input lock

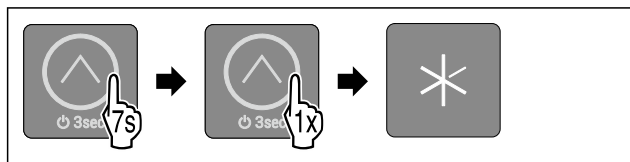

Fig. 21

- ▶ Carry out action steps according to the illustration.
- ▶ LED 1 lights up.
- ▶ After 5 seconds without interaction, input lock is automatically activated.

Deactivating the input lock

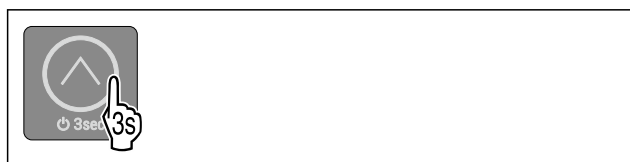

Fig. 22

- ▶ Carry out the action steps according to the illustration until you hear the confirmation tone.
- ▶ Input lock is deactivated.
- ▶ You are in the main menu.

Demo mode

Demo mode is a special feature for dealers who want to demonstrate device features. If you activate demo mode, all refrigeration functions are deactivated and you cannot open the submenu.

If you activate and then deactivate demo mode, the device will be reset to factory defaults. (see Resetting to factory settings)

Activating demo mode

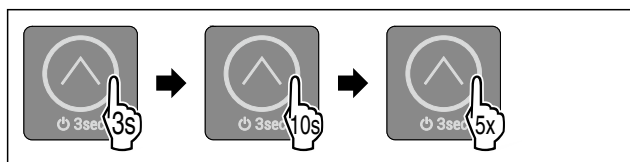

Fig. 23

- ▶ Touch the touchbutton as shown in the illustration for 3 seconds until you hear the confirmation tone.
- ▶ Device is switched off.
- ▶ Touch the touchbutton as shown in the illustration for 10 seconds until you hear the confirmation tone after 10 seconds.
- ▶ Briefly touch the touchbutton five times.
- ▶ All temperature LEDs light up twice for a short time: Demo mode is activated.
- ▶ Device is switched off.
- ▶ Switch on the device. (see Switching on the device)
- ▶ The device is in demo mode.

Deactivating demo mode

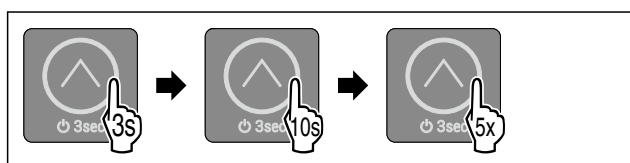

Fig. 24

- ▶ Touch the touchbutton as shown in the illustration for 3 seconds until you hear the confirmation tone.
- ▶ Device is switched off.

- ▶ Touch the touchbutton as shown in the illustration for 10 seconds until you hear the confirmation tone after 10 seconds.
- ▶ Briefly touch the touchbutton five times.
- ▶ All temperature LEDs light up briefly four times: Demo mode is deactivated.
- ▶ Device is switched off.
- ▶ Switch on the device. (see Switching on the device)

Resetting to factory settings

Use this function to reset all settings to factory defaults. All settings you have made so far (e.g. log-in data) are reset to their original settings.

Application:

- Reset device

Performing a reset

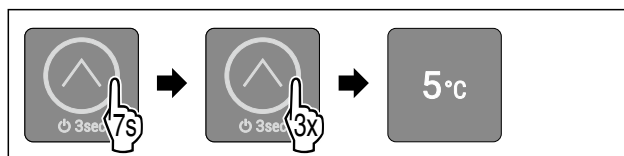

Fig. 25 Example illustration

- ▶ Carry out action steps according to the illustration.
- ▶ LED 3 lights up.
- ▶ After 5 seconds without interaction, the appliance is reset.
- ▶ Appliance is switched off.
- ▶ Switch on the appliance. (see 4.1 Switching on device (first use))
- ▶ Log-in data is reset.

7.3 Messages

Messages are indicated audibly by an alarm tone and visually by the LEDs flashing in the display. Different LEDs flash depending on the type of message.

You can end the following messages yourself. For all other messages, you must contact the customer service. (see 10.4 Customer Service)

Message	Cause	Exit the message
The alarm tone sounds at an ever-increasing volume.	The message appears if the door is open for more than 60 seconds.	Carry out action steps (see Door alarm).
Interior lighting		
Door alarm		

Overview of messages

7.3.1 Ending messages

Door alarm



Fig. 26

- ▶ End alarm: Carry out action steps according to the illustration.

-or-

- ▶ Close the door.
- ▶ Alarm has ended.

Features

- ▶ If the door is not closed: Message appears again after 3 minutes.

8 Features

8.1 4-star freezer compartment*

8.1.1 Opening the 4-star freezer compartment

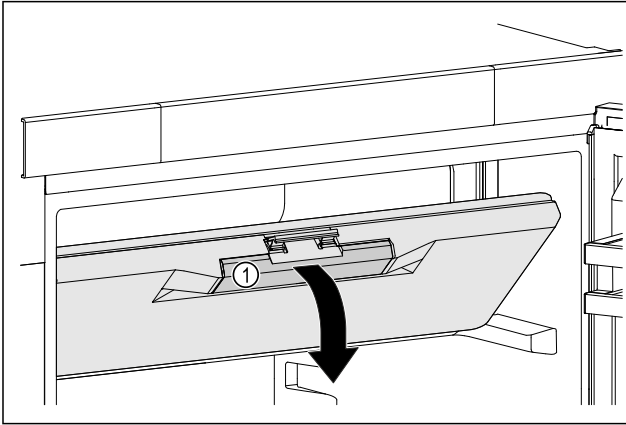

Fig. 27

- ▶ Hold the freezer compartment door by the recessed handle Fig. 27 (1).
- ▶ Pull the freezer compartment door down and forward.
- ▶ Freezer door is open.

8.1.2 Closing the 4-star freezer compartment

- ▶ Close the freezer compartment door.
- ▶ Press on the freezer compartment door at the front until it engages.
- ▶ Freezer compartment door is closed.

8.2 Door rack

Door racks are suitable for storing drinks and food. You can move door racks for your own individual use and take them apart for cleaning. However, Liebherr recommends using the door racks in the position in the door as delivered from the factory.

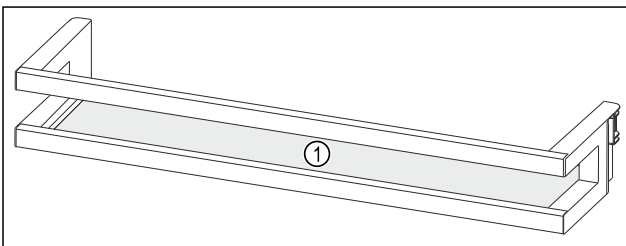

Fig. 28 Example illustration, Door rack

(1) Shelf

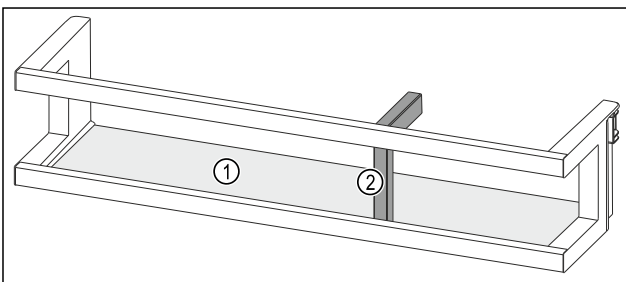

Fig. 29 Example illustration, Door rack with bottle holder

(1) Shelf

(2) Bottle holder

The following table shows examples of what can be stored in each door rack. Do not exceed the maximum loading weight of the door.

Door rack	Food
Door rack (see Fig. 28)	Butter, cheese, tinned food, tubes
Door rack with bottle holder (see Fig. 29)	Bottles The sliding bottle holder secures the bottles in the door rack.

8.2.1 Removing the door rack

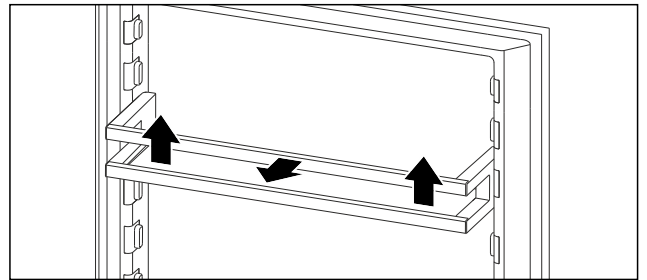

Fig. 30 Example illustration

- ▶ Push the door rack upwards.
- ▶ Pull the door rack forward.

8.2.2 Inserting the door rack

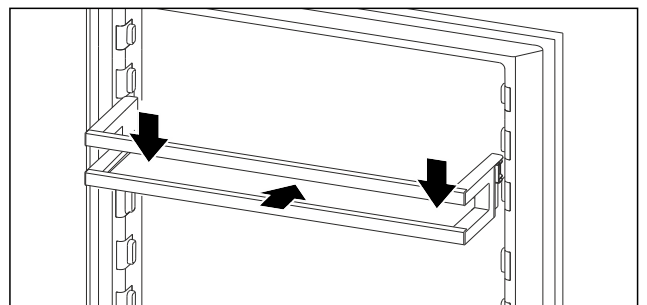

Fig. 31 Example illustration

- ▶ Slide in the door rack.
- ▶ Press the door rack down.

8.3 Drawers

You can remove the drawers for cleaning.

The way to remove/insert the drawers varies depending on the pull-out system. Your appliance can contain various pull-out systems.

Note

The energy consumption increases and the cooling power goes down if ventilation is not sufficient.

- ▶ Always keep the inside vents at the rear wall clear.

8.3.1 Drawer on appliance base or glass shelf

The drawer runs directly on the appliance base or on a glass shelf. There are no rails.

Removing drawer

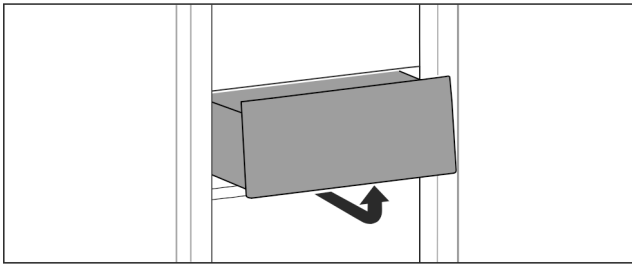

Fig. 32

- ▶ Remove drawer as shown in the illustration.

Inserting drawer

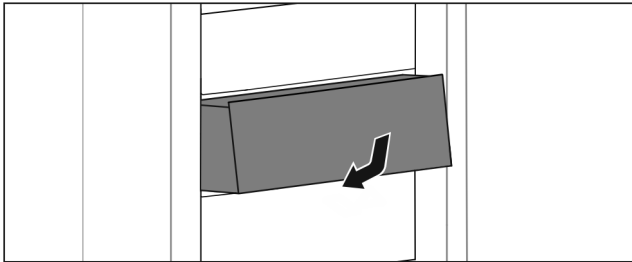

Fig. 33

- ▶ Insert drawer as shown in the illustration.

8.4 Bottle holder

8.4.1 Using the bottle holder

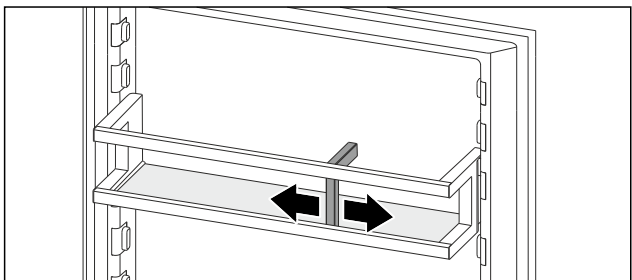

Fig. 34

- ▶ Push the bottle holder onto the bottles.
- ▶ The bottles are prevented from falling over.

9 Maintenance

9.1 FreshAir carbon filter*

The FreshAir carbon filter is in the compartment above the fan.

It guarantees the best air quality.

- ☐ Replace the carbon filter every 6 months.
- ☐ The carbon filter can be disposed of with the regular household waste.

Note

FreshAir activated charcoal filters can be purchased from the Liebherr-Hausgeräte store at home.liebherr.com/shop/de/deu/zubehor.html.

9.1.1 Removing the FreshAir carbon filter

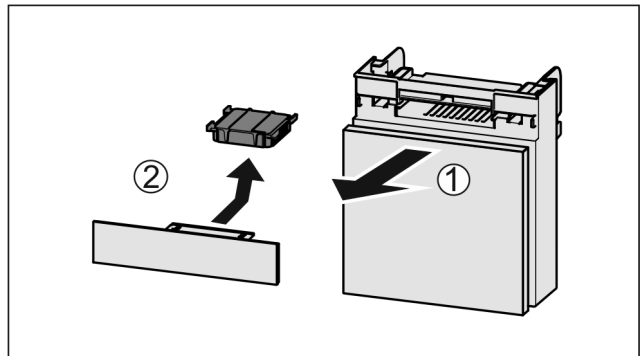

Fig. 35

- ▶ Pull out the compartment Fig. 35 (1).
- ▶ Remove the carbon filter Fig. 35 (2).

9.1.2 Inserting the FreshAir carbon filter

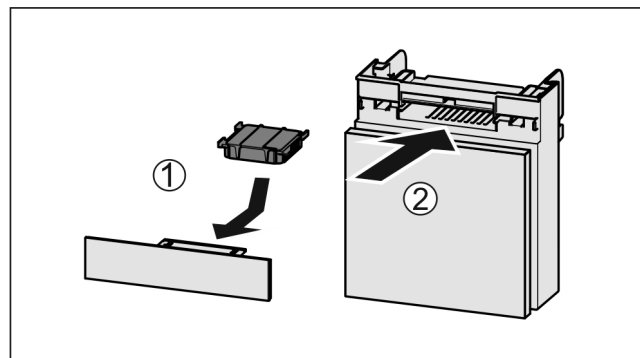

Fig. 36

- ▶ Insert the carbon filter as shown in the diagram Fig. 36 (1).
- ▶ The carbon filter clicks into place.
- ▶ If the carbon filter is pointing downwards:
- ▶ Push the compartment in Fig. 36 (2).
- ▶ The carbon filter is now ready for use.

9.2 Removing the bottle holder

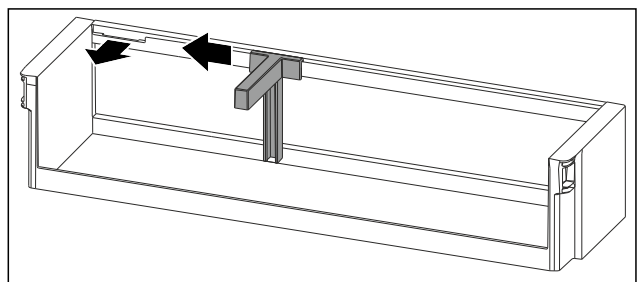
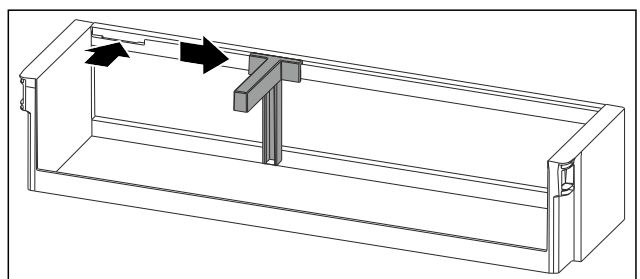

Fig. 37

- ▶ Slide the bottle holder to the side as far as the recess.
- ▶ Remove the bottle holder forwards.

9.3 Inserting the bottle holder



Maintenance

Fig. 38

- ▶ Insert the bottle holder in the recess.
- ▶ Push the bottle holder to the desired position to the side.

9.4 Disassembling / assembling pull-out systems

9.4.1 Notes on disassembly

You can disassemble some of the pull-out systems for cleaning. Your appliance can contain a variety of pull-out systems.

The following pull-out systems can be disassembled or cannot be disassembled:

Pull-out system	can be disassembled / cannot be disassembled
Drawer on appliance base or glass shelf	cannot be disassembled

9.5 Defrosting the appliance



WARNING

Improper defrosting of the appliance!
Injuries and damage.

- ▶ Do not use mechanical equipment or other methods to speed up the defrosting process other than those recommended by the manufacturer.
- ▶ Do not use electrical heating or steam-cleaning appliances, naked flames or defroster sprays to defrost.
- ▶ Do not use sharp objects to remove ice.

Defrosting is performed automatically. The water from the thawing process drains through the outlet and evaporates.

Water drops or a thin layer of frost or ice can form on the back wall; this is a completely normal part of the appliance's function. This must not be removed.

- ▶ Clean the drain opening at regular intervals. (see 9.7 Cleaning the appliance)

9.6 Defrosting the freezer compartment manually*

A layer of frost or ice forms after prolonged use.

The following factors promote the formation of frost or ice:

- The appliance is opened frequently.
- Hot food is put in.
- ▶ Switch the appliance off.
- ▶ Pull the mains plug out of the socket or switch the fuse off.
- ▶ Wrap the frozen food in newspaper or blankets and store in a cool place.

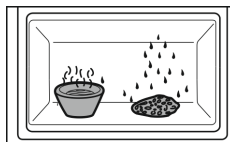

- ▶ Place a saucepan of hot but not boiling water in the freezer compartment.
- ▶ This speeds up the defrosting process.
- ▶ Leave the compartment and appliance door open during defrosting.
- ▶ Remove loosened pieces of ice.
- ▶ Soak up the melted ice water with a sponge or cloth several times as necessary.
- ▶ Clean the appliance. (see 9.7 Cleaning the appliance)

9.7 Cleaning the appliance

9.7.1 Ready



WARNING

Danger of electric shock!

- ▶ Remove the refrigerator connector or interrupt the power supply.



WARNING

Risk of fire

- ▶ Do not damage the refrigeration circuit.

- ▶ Empty the appliance.
- ▶ Remove mains connector.

9.7.2 Cleaning the interior

NOTICE

Improper cleaning!

Damage to the appliance.

- ▶ Only use soft cleaning cloths and ph-neutral all-purpose cleaners.
- ▶ Do not use abrasive sponges or steel wool which may cause scratches.
- ▶ Do not use any sharp or abrasive cleaning agents, nor any that contain sand, chloride or acid.
- ▶ Plastic surfaces: clean by hand with a soft clean cloth, lukewarm water and a little detergent.
- ▶ Metal surfaces: clean by hand with a soft clean cloth, lukewarm water and a little detergent.
- ▶ Drain hole: remove deposits using a thin item (for example a cotton bud).

9.7.3 Clean the components

NOTICE

Improper cleaning!

Damage to the appliance.

- ▶ Only use soft cleaning cloths and ph-neutral all-purpose cleaners.
- ▶ Do not use abrasive sponges or steel wool which may cause scratches.
- ▶ Do not use any sharp or abrasive cleaning agents, nor any that contain sand, chloride or acid.

Clean with a soft, clean cloth, lukewarm water and some detergent:

- Door rack
- Shelf
- Drawer

Wash in the dishwasher up to 60 °C:

- Bottle rack
- ▶ To disassemble components: see the relevant section.
- ▶ Clean the components.

9.7.4 After cleaning

- ▶ Wipe the appliance and the components dry.
- ▶ Connect and switch on the appliance. The temperature is cold enough:
- ▶ Place the food inside.
- ▶ Repeat cleaning regularly.

10 Customer help

10.1 Technical specifications

Temperature range	
Cooling	2 °C to 9 °C

Maximum ice cube quantity / 24 hours	
Freezer compartment*	see type plate under "Freezing capacity .../ 24 h" *

10.2 Operating noises

The appliance makes different noises when it is on.

- At **higher temperatures** the appliance uses less energy but works for longer. It is **quieter**.
- At **lower temperatures** the food is cooled faster. It is **louder**.

Examples:

- Functions on (see 7.2 Appliance functions)
- Fan running*
- Food recently added
- High ambient temperature
- Door open for a while

Noise	Possible cause	Type of noise
Bubbling and splashing	Coolant flowing into the cooling circuit.	Normal operating noise
Hissing	Coolant sprays into the cooling circuit.	Normal operating noise
Humming	The appliance is cooling. The volume depends on the cooling output.	Normal operating noise

Noise	Possible cause	Type of noise
Humming and rustling*	The fan is running.*	Normal operating noise*
Clicking	Components are switched on and off.	Normal switching noise
Rattling or humming	Valves or flaps are working.	Normal switching noise

Noise	Possible cause	Type of noise	Lifting
Vibration	Improper installation	Defective noise	Check the installation. Level the appliance.
Rattling	Components, items inside the appliance	Defective noise	Secure components. Leave enough space between the items.

10.3 Technical fault

Your appliance is designed and built to ensure it works reliably and has a long service life. In the unlikely event that a fault occurs during operation, please check whether it is due to an operating error. If so, you will be charged for the callout and repair costs even if it falls within the warranty period.

You can fix the following faults yourself.

10.3.1 Appliance function

Defect	Cause	Remedy
The appliance is not working.	→ The appliance is not switched on.	▶ Switch the appliance on.
	→ The power plug is not properly plugged into the socket.	▶ Check the power plug.
	→ There is something wrong with the power outlet fuse.	▶ Check the fuse.
	→ Power cut	▶ Keep the appliance closed. ▶ Safeguarding food: Place cold packs on top of food or use another freezer if the power cut lasts longer.* ▶ Do not refreeze defrosted food.*
	→ The IEC socket is not plugged into the appliance correctly.	▶ Check the IEC socket.
Temperature is not cold enough.	→ The appliance door is not closed properly.	▶ Close the appliance door.
	→ Not enough ventilation.	▶ Keep ventilation grille clear, and clean it.
	→ The ambient temperature is too high.	▶ Problem solution: (see 1.2 Climate classes)

Customer help

Defect	Cause	Remedy
	→ The appliance was opened too many times or for too long.	▶ Wait to see if the required temperature corrects itself. If not, contact Customer Service. (see 10.4 Customer Service)
	→ The temperature is set incorrectly.	▶ Turn down the temperature and check after 24 hours.
	→ The appliance is too close to a heat source (oven, radiator, etc).	▶ Move the appliance or the heat source.
	→ The appliance was not correctly installed in the recess.	▶ Check if the appliance was installed correctly and that the door closes properly.
The door seal is defective or needs to be replaced for another reason.	→ The door seal can be replaced. It can be replaced without the need for special tools.	▶ Contact Customer Service. (see 10.4 Customer Service)
The appliance builds up too much ice or condensation.	→ The door seal may have slipped out of its groove.	▶ Check that the door seal is well fitted in the groove.

10.3.2 Features

Defect	Cause	Remedy
The internal light does not come on.	→ The appliance is not switched on.	▶ Switch the appliance on.
	→ The door was open for longer than 15 minutes.	▶ Interior lighting switches off automatically after about 15 minutes when the door is open.
	→ The LED interior light is faulty or the lid is damaged.	▶ Contact Customer Service. (see 10.4 Customer Service)
The freezer compartment cannot be closed.*	→ The lock is on when the door is open.	▶ Use the handle again.

10.4 Customer Service

First check whether you can rectify the fault yourself (see 10 Customer help) . If you cannot rectify the problem, contact Customer Service.

You can find the address in the enclosed brochure “Liebherr-Service” or at home.liebherr.com/service.



WARNING

Unprofessional repair!
Injuries.

- ▶ Have any repairs and action - not expressly specified - on the appliance and mains cable carried out by service personnel only. (see 9 Maintenance)
- ▶ A damaged mains cable may only be replaced by the manufacturer, the manufacturer’s Customer Service or a similarly qualified person.
- ▶ In the case of appliances with an IEC connector, the change may be made by the customer.

10.4.1 Contacting Customer Service

Make sure that the following appliance information is available:

- Appliance name (model and index)
- Service no. (Service)
- Serial no. (S no.)

- ▶ Refer to the type plate for device information. (see 10.5 Model plate)
- ▶ Note down the appliance information.
- ▶ Notify customer service: Report errors and the appliance information.
- ▶ This will help us to provide you with a faster, more accurate service.
- ▶ Follow further instructions from Customer Service.

10.5 Model plate

The type plate is located on the bottom inside of the machine.

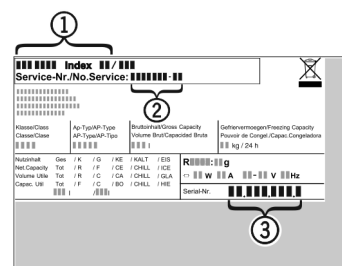

Fig. 39

- (1) Appliance description (3) Serial no.
- (2) Service no.
- ▶ Note the data on the model plate.

11 Shutting down

- ▶ Empty the appliance.
- ▶ Switch off appliance. (see Switching the appliance off and on)
- ▶ Pull the mains plug out of the socket.
- ▶ Remove the IEC socket if required: Pull the IEC socket out of the appliance plug and move it to the left and right at the same time.
- ▶ Clean appliance. (see 9.7 Cleaning the appliance)
- ▶ Leave the door open, so that no unpleasant odours arise.

12 Disposal

Ensure that the following requirements are met:

- Meaning of the symbols on the appliance: are familiar. (see 1.12 Symbols on the appliance)
- Notes on disposal are familiar. (see 1.8 Disposal)

12.1 Preparing the appliance for disposal

- ▶ Shutting your appliance down. (see 11 Shutting down)

12.2 Disposing of the appliance in an environmentally friendly manner



WARNING

Leaking coolant and oil!

Fire. The coolant contained in the appliance is eco-friendly, but also flammable. The oil contained in the appliance is flammable. Escaping coolant and oil can ignite if the concentration is high enough and in contact with an external heat source.

- ▶ Do not damage the pipelines of the coolant circuit and the compressor.
-
- ▶ Observe the notes on transporting the appliance.
 - ▶ Remove the appliance without damaging it.
 - ▶ Dispose of appliance according to specifications.



home.liebherr.com/fridge-manuals

EN base unit fridge

Issue date: 20260217

Part number index: 7083751-00

Liebherr-Hausgeräte GmbH
Memminger Straße 77-79
88416 Ochsenhausen
Deutschland