

Translation of the Original Operating Manual

# Operating Manual

Ultra Low Temperature Freezer SUFsg

**Read the operating manual prior to commissioning**

	Model	Gross content in liters	Voltage
	SUFsg 3501,001	402	230 V
	SUFsg 5001,001	491	230 V
	SUFsg 7001,001	728	230 V
	SUFsg 5001,123	491	208-230 V
	SUFsg 7001,123	728	208-230 V
<b>UL chambers</b>	SUFsg 3501,137	402	115 V
	SUFsg 5001,137	491	115 V
	SUFsg 7001,137	728	115 V
<b>Chambers with water cooling</b>	SUFsg 5001,H72	491	230 V
	SUFsg 7001,H72	728	230 V

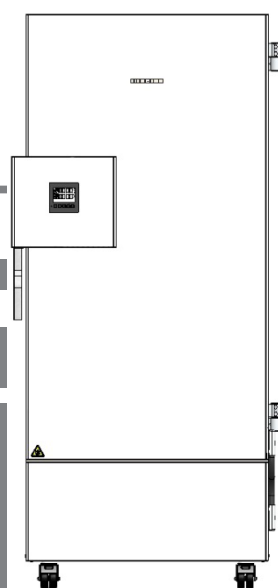

SUFsg 3501  
SUFsg 5001  
SUFsg 7001

**7083 438-00**

**LIEBHERR**

## Contents

<b>1. SAFETY</b>	<b>6</b>
1.1 Personnel Qualification	6
1.2 Operating manual	6
1.3 Legal considerations	6
1.3.1 Intellectual property	7
1.4 Structure of the safety instructions	7
1.4.1 Signal word panel	7
1.4.2 Safety alert symbol	8
1.4.3 Pictograms	8
1.4.4 Word message panel structure	9
1.5 Localization / position of safety labels at the chamber	9
1.6 Type plate	10
1.7 General safety instructions on installing and operating the chamber	11
1.8 Intended use	13
1.9 Foreseeable Misuse	15
1.10 Residual Risks	15
1.11 Operating instructions	17
1.12 Measures to prevent accidents	17
<b>2. CHAMBER DESCRIPTION</b>	<b>18</b>
2.1 Chamber overview	20
2.2 Door lock and controller housing	22
2.2.1 Operating the door lock	22
2.3 Main power switch	23
2.4 Chamber rear	24
2.5 Doors	25
2.5.1 Outer door	25
2.5.2 Compartment doors	25
<b>3. COMPLETENESS OF DELIVERY, TRANSPORTATION, STORAGE, AND INSTALLATION</b>	<b>26</b>
3.1 Unpacking, and checking equipment and completeness of delivery	26
3.2 Guidelines for safe lifting and transportation	27
3.2.1 Moving the freezer inside a building	27
3.2.2 Transport outside a building	28
3.3 Storage	29
3.4 Location of installation and ambient conditions	29
<b>4. INSTALLATION AND CONNECTIONS</b>	<b>31</b>
4.1 Operating instructions	31
4.2 Spacers for rear wall distance	31
4.3 Support feet (SUFsg 3501 only)	31
4.4 Adjustable shelves	32
4.5 Connections of cooling water for chambers with water cooling	34
4.5.1 Connection of cooling water outlet for water cooling	34
4.5.2 Connection of cooling water inlet for water cooling	35
4.5.3 Connection kit for cooling water	35
4.6 Electrical connection	37
<b>5. FUNCTIONAL OVERVIEW OF THE CHAMBER CONTROLLER</b>	<b>38</b>
5.1 Menu structure of the controller and access levels	39
<b>6. START UP</b>	<b>40</b>
6.1 Preset factory parameters	40
6.2 Behavior after turning on the chamber	40

<b>7.</b>	<b>TEMPERATURE SET-POINT ENTRY .....</b>	<b>41</b>
7.1	Setting the Manual Offset value .....	42
<b>8.</b>	<b>PLACING SAMPLES IN STORAGE IN THE FREEZER.....</b>	<b>43</b>
<b>9.</b>	<b>SETTING SPECIAL CONTROLLER FUNCTIONS .....</b>	<b>44</b>
<b>10.</b>	<b>PASSWORD.....</b>	<b>45</b>
10.1	Password request .....	45
10.2	Assign and modify a password .....	45
10.2.1	Assign and modify the User password .....	46
10.2.2	Assign and modify the Admin password .....	46
10.3	Performance during and after power failure and shut down .....	47
<b>11.</b>	<b>SAFETY CONTROLLER (TEMPERATURE SAFETY DEVICE).....</b>	<b>47</b>
11.1	Setting the safety controller mode .....	48
11.2	Setting the safety controller value .....	48
11.3	Message and measures in the state of alarm .....	49
11.4	Function check .....	49
<b>12.</b>	<b>GENERAL CONTROLLER SETTINGS.....</b>	<b>50</b>
12.1	Selecting the controller's menu language .....	50
12.2	Selecting the temperature unit .....	50
12.3	Setting the current date .....	51
12.4	Setting the current time .....	52
12.5	Function "Language selection at restart" .....	52
12.6	Setting the chamber address .....	53
12.7	Display brightness .....	53
<b>13.</b>	<b>SETTING THE ALARM LIMIT FOR RANGE ALARM AND THE ALARM DELAYS .....</b>	<b>54</b>
13.1	Setting the delay time for door open alarm .....	54
13.2	Setting the delay time for range alarm .....	54
13.3	Setting the alarm limit of the range alarm .....	55
<b>14.</b>	<b>ALARM FUNCTIONS .....</b>	<b>56</b>
14.1	Alarm messages .....	56
14.2	Information messages .....	58
14.3	Activating / deactivating the audible alarm (alarm buzzer) .....	58
14.4	Required actions in case of an alarm.....	59
14.4.1	Safety controller temperature alarm .....	59
14.4.2	Temperature range alarm (too high and too low temperature) .....	59
14.4.3	Door open alarm.....	60
14.4.4	Power failure alarm.....	60
14.4.5	Messages on the battery management system .....	61
14.4.6	Messages referring to temperature sensor failure .....	62
14.4.7	Messages referring to CO <sub>2</sub> emergency cooling (option CO <sub>2</sub> emergency cooling) .....	63
14.5	Zero-voltage relay alarm output .....	64
<b>15.</b>	<b>ETHERNET NETWORK SETTINGS .....</b>	<b>65</b>
15.1	Showing the network settings .....	65
15.1.1	Showing the chamber's MAC address .....	65
15.1.2	Showing the IP address.....	65
15.1.3	Showing the subnet mask .....	66
15.1.4	Showing the standard gateway .....	66
15.1.5	Showing the DNS server address .....	66
15.1.6	Showing the DNS chamber name .....	67

15.2	Changing the configuration of the network settings .....	67
15.2.1	Selecting the type of IP address assignment (automatic / manual) .....	67
15.2.2	Selecting the type of assignment of the DNS server address (automatic / manual).....	68
15.2.3	Assigning the IP address.....	68
15.2.4	Setting the subnet mask.....	69
15.2.5	Setting the standard gateway.....	69
15.2.6	Assigning the DNS server address .....	70
<b>16.</b>	<b>DATA RECORDER .....</b>	<b>70</b>
16.1	Recorded data.....	70
16.2	Storage capacity .....	71
16.3	Setting the storage rate for the "DL1" recorder data.....	71
16.4	Deleting the data recorder.....	71
<b>17.</b>	<b>USB-MENU: DATA TRANSFER VIA USB INTERFACE .....</b>	<b>72</b>
17.1	Connecting the USB stick .....	72
17.2	Import function .....	72
17.3	Export functions .....	73
17.4	Ongoing data transfer .....	73
17.5	Error during data transmission.....	74
17.6	Removing the USB stick .....	74
<b>18.</b>	<b>BATTERY MANAGEMENT SYSTEM .....</b>	<b>74</b>
18.1	Battery operation.....	74
18.2	Charging voltage.....	75
<b>19.</b>	<b>SETTING AND ACTIVATING THE SERVICE SETPOINT .....</b>	<b>75</b>
19.1	Setting the service setpoint.....	75
19.2	Activating the service setpoint.....	76
<b>20.</b>	<b>CO<sub>2</sub> EMERGENCY COOLING (OPTION FOR SUFSG 5001, SUFSG 7001) .....</b>	<b>77</b>
20.1	Connecting and exchanging the pressurized CO <sub>2</sub> cylinder.....	78
20.2	Operating the CO <sub>2</sub> emergency cooling system.....	80
20.3	Settings on the chamber controller .....	81
20.3.1	Setting the CO <sub>2</sub> emergency cooling temperature setpoint.....	82
20.3.2	Activating the CO <sub>2</sub> emergency cooling.....	82
20.3.3	Test run of the CO <sub>2</sub> emergency cooling .....	83
<b>21.</b>	<b>DATA MONITORING AND RECORDING .....</b>	<b>84</b>
21.1	Ethernet interface.....	84
21.2	Analog output for temperature (option).....	84
<b>22.</b>	<b>CHAMBER INVENTORY: STORAGE RACK SYSTEMS AND CRYO BOXES (OPTION).....</b>	<b>85</b>
22.1	Storage rack systems with or without cryo boxes.....	85
22.2	Cryo boxes .....	85
<b>23.</b>	<b>CLEANING AND DECONTAMINATION .....</b>	<b>86</b>
23.1	Cleaning .....	86
23.2	Decontamination / chemical disinfection.....	88
<b>24.</b>	<b>MAINTENANCE AND SERVICE, SERVICE, TROUBLESHOOTING, REPAIR, TESTING .....</b>	<b>89</b>
24.1	General information, personnel qualification.....	89
24.2	Maintenance work by the customer .....	90
24.2.1	Checking and cleaning / replacing the condenser air filter.....	90
24.2.2	Cleaning the condenser.....	91
24.2.3	De-icing and defrosting.....	91

24.2.4	Maintenance of the door lock .....	92
24.3	Maintenance intervals, service.....	93
24.4	Service Reminder.....	93
24.5	Simple troubleshooting.....	94
24.6	Sending the chamber back .....	96
<b>25.</b>	<b>DISPOSAL.....</b>	<b>97</b>
25.1	Disposal of the transport packing.....	97
25.2	Decommissioning .....	97
25.3	Disposal of the chamber in the member states of the EU .....	97
25.4	Disposal of the chamber in non-member states of the EU .....	99
<b>26.</b>	<b>TECHNICAL DESCRIPTION.....</b>	<b>99</b>
26.1	Factory calibration and adjustment .....	99
26.2	Over current protection .....	99
26.3	Technical data.....	100
26.4	Equipment and options, accessories and spare parts (extract).....	103
26.5	Dimensions SUFsg 3501 .....	105
26.6	Dimensions SUFsg 5001 .....	106
26.7	Dimensions SUFsg 7001 .....	107
<b>27.</b>	<b>EU DECLARATION OF CONFORMITY .....</b>	<b>108</b>
<b>28.</b>	<b>CONTAMINATION CLEARANCE CERTIFICATE .....</b>	<b>109</b>

Dear Customer,

For the correct operation of the SUFsg ultra-low temperature freezer, it is important that you read this operating manual completely and carefully and observe all instructions as indicated. Failure to read, understand and follow the instructions may result in personal injury. It can also lead to damage to the chamber and/or poor equipment performance.

## 1. Safety

### 1.1 Personnel Qualification



The chamber must only be installed, tested, and started up by personnel qualified for assembly, startup, and operation of the chamber. Qualified personnel are persons whose professional education, knowledge, experience and knowledge of relevant standards allow them to assess, carry out, and identify any potential hazards in the work assigned to them. They must have been trained and instructed, and be authorized, to work on the chamber.

The chamber should only be operated by laboratory personnel especially trained for this purpose and familiar with all precautionary measures required for working in a laboratory. Observe the national regulations on minimum age of laboratory personnel.

### 1.2 Operating manual

This operating manual is part of the components of delivery. Always keep it handy for reference in the vicinity of the chamber. If selling the unit, hand over the operating manual to the purchaser.

To avoid injuries and damage observe the safety instructions of the operating manual. Failure to follow instructions and safety precautions can lead to significant risks.

	<p style="text-align: center;"> <b>DANGER</b></p> <p><b>Dangers due to failure to observe the instructions and safety precautions. Serious injuries and chamber damage. Risk of death.</b></p> <ul style="list-style-type: none"><li>➤ Observe the safety instructions in this Operating Manual.</li><li>➤ Follow the operating procedures in this Operating Manual.</li><li>➤ Carefully read the complete operating instructions of the chamber prior to installing and using the chamber.</li><li>➤ Keep the operating manual for future reference</li></ul>
---	---

	Make sure that all persons who use the chamber and its associated work equipment have read and understood the Operating Manual.
---	---

This Operating Manual is supplemented and updated as needed. Always use the most recent version of the Operating Manual. When in doubt, call the manufacturer's Service Hotline for information on the up-to-dateness and validity of this Operating Manual.

### 1.3 Legal considerations

This operating manual is for informational purposes only. It contains information for correct and safe installing, start-up, operation, decommissioning, cleaning and maintenance of the product. Note: the contents and the product described are subject to change without notice.

Understanding and observing the instructions in this operating manual are prerequisites for hazard-free use and safety during operation and maintenance. Images are to provide basic understanding. They may deviate from the actual version of the chamber. The actual scope of delivery can, due to optional or special design, or due to recent technical changes, deviate from the information and illustrations in these instructions this operating manual. In no event shall the manufacturer be held liable for any damages, direct or incidental arising out of or related to the use of this manual.

This operating manual cannot cover all conceivable applications. If you would like additional information, or if special problems arise that are not sufficiently addressed in this manual, please ask your dealer or contact us directly, e.g. by phone at the number located on page one of this manual

Furthermore, we emphasize that the contents of this operating manual are not part of an earlier or existing agreement, description, or legal relationship, nor do they modify such a relationship. All obligations on the part of the manufacturer derive from the respective purchase contract, which also contains the entire and exclusively valid statement of warranty administration and the general terms and conditions, as well as the legal regulations valid at the time the contract is concluded. The statements in this manual neither augment nor restrict the contractual warranty provisions.

### 1.3.1 Intellectual property

**This operating manual is protected by copyright. Any unauthorized copying or disclosure to third parties is strictly prohibited. We reserve the right to take legal action and, if necessary, to assert claims for damages in the event of infringement.**

## 1.4 Structure of the safety instructions

In this operating manual, the following safety definitions and symbols indicate dangerous situations in accordance with the standards ISO 3864-2 and ANSI Z535.6.

### 1.4.1 Signal word panel

Depending on the probability of serious consequences, potential dangers are identified with a signal word, the corresponding safety color, and if appropriate, the safety alert symbol.

 <b>DANGER</b>
Indicates an imminently hazardous situation that, if not avoided, will result in death or serious (irreversible) injury.

 <b>WARNING</b>
Indicates a potentially hazardous situation which, if not avoided, could result in death or serious (irreversible) injury

 <b>CAUTION</b>
Indicates a potentially hazardous situation which, if not avoided, may result in moderate or minor (reversible) injury

<b>NOTICE</b>
Indicates a potentially hazardous situation which, if not avoided, may result in damage to the product and/or its functions or of a property in its proximity.

## 1.4.2 Safety alert symbol



Use of the safety alert symbol indicates a **risk of injury**.

Observe all measures that are marked with the safety alert symbol in order to avoid death or injury.

## 1.4.3 Pictograms

Warning signs			
 Electrical hazard	 Very cold surface	 Explosive atmosphere	 Stability hazard
 CO <sub>2</sub> suffocation hazard	 Gas cylinders	 Pollution Hazard	 Harmful substances
 Biohazard	 Risk of corrosion and / or chemical burns		
Mandatory action signs			
 Mandatory regulation	 Read operating instructions	 Disconnect the power plug	 Lift with mechanical assistance
 Environment protection	 Wear protective gloves	 Wear safety goggles	
Prohibition signs			
 Do NOT touch	 Do NOT spray with water	 Do NOT climb	



**Information** to be observed in order to ensure optimum function of the product.



## 1.4.4 Word message panel structure

**Type / cause of hazard.**





**Possible consequences.**

- ⊘ Instruction on how to avoid the hazard: prohibition
- Instruction on how to avoid the hazard: mandatory action

Observe all other notes and information not necessarily emphasized in the same way, in order to avoid disruptions that could result in direct or indirect injury or property damage.

## 1.5 Localization / position of safety labels at the chamber

The following labels are located on the chamber:

Pictograms (Warning signs)	Information
 <p>Very cold surface: Risk of freezing</p>	 <p>Energy Star Symbol (only SUFsg 5001 and 7001)</p>
 <p>Risk of injury. Observe the safety instructions in the operating manual. (only UL chambers and chambers with optional CO<sub>2</sub> emergency cooling)</p>	 <p>Flammable refrigerants (only SUFsg 5001,123, SUFsg 7001,123, SUFsg 3501,137, SUFsg 5001,137, SUFsg 7001,137))</p>

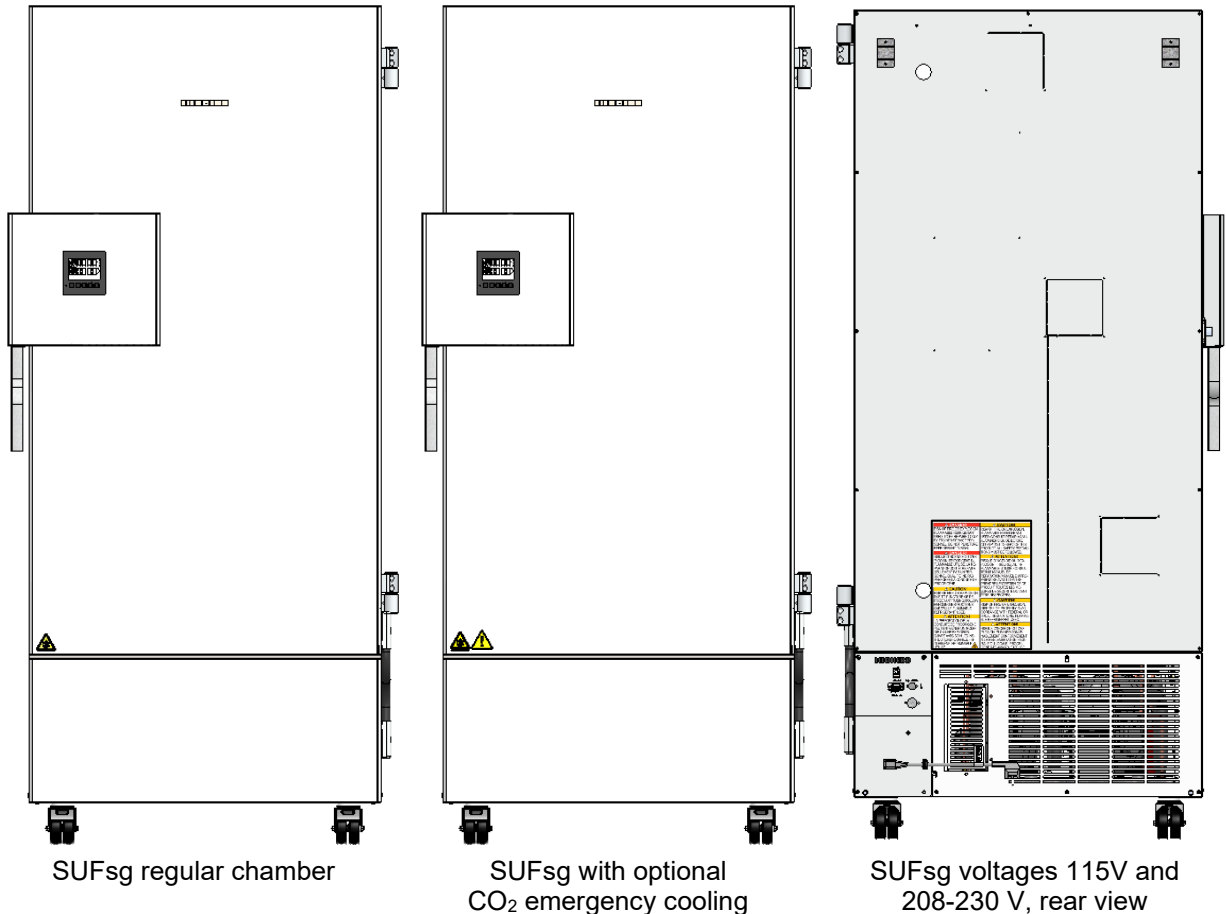

Figure 1: Position of labels on the ultra-low temperature freezer SUFsg



Keep safety labels complete and legible.

Replace safety labels that are no longer legible. Contact the manufacturer's Service for these replacements.

## 1.6 Type plate

The type plate sticks to the left side of the chamber, bottom right-hand.



Nominal temp.	-90 °C -130 °F	1,60 kW / 7,0 A 230 V / 50 Hz			Gross volume: 491 liter Max. operating pressure 28 bar Contains hydrocarbon gases Ultra-Tiefkühlschrank Congélateur à ultra-basse temp Низкотемпературный морозильник
Ambient temp.	+16 °C - +32 °C				
IP protection	20				
Phase	1 N ~	107			
		Ultra Low Temperature Freezer			
Stage 1: R290	0,15 kg	<b>SUFsg 5001-70B 001</b>			
Stage 2: R170	0,15 kg				
<b>LIEBHERR</b>	Liebherr Hausgeräte GmbH Memminger Straße 77-79 D-88416 Ochsenhausen		<b>Service No.</b>	<b>Serial No. 69.000.001.4</b>	Made in Germany / Сделано в Германии
			<b>993356902</b>		

Figure 2: SUFG type plate (example SUFG 5001,001)

Nominal temp.	-90 °C -130 °F	1,80 kW / 11,7 A 115 V / 60 Hz			Gross volume: 491 liter Max. operating pressure 28 bar Contains hydrocarbon gases Ultra-Tiefkühlschrank Congélateur à ultra-basse temp Низкотемпературный морозильник
Ambient temp.	+16 °C - +32 °C				
IP protection	20				
Phase	1 N ~	107			
		Ultra Low Temperature Freezer			
Stage 1: R290	0,15 kg	<b>SUFsg 5001-70B 137</b>			
Stage 2: R170	0,15 kg				
<b>LIEBHERR</b>	Liebherr Hausgeräte GmbH Memminger Straße 77-79 D-88416 Ochsenhausen		<b>Service No.</b>	<b>Serial No. 69.000.001.4</b>	Made in Germany / Сделано в Германии
			<b>090433602</b>		





Figure 3: SUFG type plate (example SUFG 5001,137)

### Indications of the type plate (example):

Indication		Information
LIEBHERR		Distributor: Liebherr Hausgeräte GmbH
SUFGsg 5001-70B 001		Model designation
Ultra Low Temperature Freezer		Chamber name
Serial No. 69.000.001.4		Serial no. of the chamber
Service No. 993356901		Service no. of the chamber
Nominal temp.	-90 °C -130 °F	Nominal temperature
Ambient temp.	+16 °C - +32 °C	Permissible ambient temperature during operation
IP protection	20	IP type of protection acc. to standard EN 60529
1,60 kW		Nominal power
7,0 A		Nominal current
230 V / 50 Hz		Nominal voltage +/- 10% at the indicated power frequency
Phase 1 N ~		Current type
Gross volume: 500 liter		Volume of the chamber interior

Indication	Information
Max. operating pressure 28 bar	Max operating pressure in the refrigerating system
Contains hydrocarbon gases	Contains hydrocarbon gases
Stage 1: R290 – 0,15 kg	Cooling 1 <sup>st</sup> stage: Refrigerant type, filling weight
Stage 2: R170 – 0,15 kg	Cooling 2 <sup>nd</sup> stage: Refrigerant type, filling weight

## Symbols on the type plate:

Symbol	Applies to	Information
	All models	CE conformity marking
	All models except SUFsg 3501,137 SUFsg 5001,137 SUFsg 7001,137	Electrical and electronic equipment manufactured / placed on the market in the EU after 13 August 2005 and to be disposed of in a separate collection according to directive 2012/19/EU on waste electrical and electronic equipment (WEEE).
	SUFsg 5001,001 SUFsg 7001,001 SUFsg 5001,H72 SUFsg 7001,H72 Not valid for SUFsg 3501	The chamber is certified according to Customs Union Technical Regulation (CU TR) for the Eurasian Economic Union (Russia, Belarus, Armenia, Kazakhstan Kyrgyzstan).
	SUFsg 3501,137 SUFsg 5001,137 SUFsg 7001,137	The chamber is certified by Underwriters Laboratories Inc.® according to the following standards: <ul style="list-style-type: none"> <li>• UL 61010-1, 3<sup>rd</sup> Edition, 2012-05, Rev. 2018-11</li> <li>• CAN/CSA-C22.2 No. 61010-1-12, 3<sup>rd</sup> Edition, Amendment 1:2018, 2012-05, Rev. 2018-11</li> <li>• IEC 61010-2-011:2019</li> <li>• UL 61010-2-011 (IEC 61010-2-011:2016)</li> </ul>
	SUFsg 3501,137 SUFsg 5001,137 SUFsg 7001,137	Observe the safety instructions in the operating manual

## 1.7 General safety instructions on installing and operating the chamber

With regard to operating the chamber and to the installation location, please observe the local and national regulations relevant to your country.



The manufacturer is only responsible for the safety features of the chamber provided skilled electricians or qualified personnel authorized by the manufacturer perform all maintenance and repair, and if components relating to chamber safety are replaced in the event of failure with original spare parts.

To operate the chamber, use only original accessories from the manufacturer or accessories from third-party suppliers authorized by the manufacturer. The user is responsible for any risk caused by using unauthorized accessories.



	<b>NOTICE</b>
	<p><b>Danger of overheating due to lack of ventilation.</b>  <b>Damage to the chamber.</b></p> <ul style="list-style-type: none"> <li>⊘ Do NOT install the chamber in unventilated recesses.</li> <li>➤ Ensure sufficient ventilation for dispersal of the heat.</li> <li>➤ Observe the prescribed minimum distances when installing the chamber (chap. 3.4)</li> </ul>

	<b>NOTICE</b>
	<p><b>Danger to the environment by leakage of refrigerant in the event of a chamber defect.</b>  <b>Alteration of the environment.</b></p> <ul style="list-style-type: none"> <li>➤ Ensure sufficient ventilation of the installation site.</li> </ul>

Do not install or operate the chamber in hazardous locations.



	 <b>DANGER</b>
	<p><b>Danger of explosion due to combustible dusts or explosive mixtures in the vicinity of the chamber.</b>  <b>Serious injury or death from burns and / or explosion pressure.</b></p> <ul style="list-style-type: none"> <li>⊘ Do NOT operate the chamber in potentially explosive areas.</li> <li>➤ KEEP combustible dust or air-solvent mixtures AWAY from the chamber.</li> </ul>



The chamber does not dispose of any measures of explosion protection.

	 <b>DANGER</b>
	<p><b>Danger of explosion due to introduction of flammable or explosive substances in the chamber.</b>  <b>Serious injury or death from burns and / or explosion pressure.</b></p> <ul style="list-style-type: none"> <li>⊘ Do NOT introduce any substance into the chamber which is combustible or explosive at working temperature.</li> <li>⊘ Do NOT introduce any combustible dust or air-solvent mixture in the inner chamber.</li> </ul>

Any solvent contained in the charging material must not be explosive or inflammable. I.e., irrespective of the solvent concentration in the steam room, NO explosive mixture with air must form. The temperature inside the chamber must lie below the flash point or below the sublimation point of the charging material. Familiarize yourself with the physical and chemical properties of the charging material.



Familiarize yourself with any potential health risks caused by the charging material. Take adequate measures to exclude any risk prior to putting the chamber into operation.



 	 <b>WARNING</b>
	<p><b>Danger of intoxication and infection through contamination of the chamber with toxic, infectious or radioactive substances.</b>  <b>Damages to health.</b></p> <ul style="list-style-type: none"> <li>➤ Protect the interior of the chamber against contamination by toxic, infectious or radioactive substances.</li> <li>➤ Take appropriate measures when bringing in or taking out toxic, infectious or radioactive substances.</li> </ul>

	 <b>DANGER</b>
	<p><b>Electrical hazard by water entering the chamber.</b>  <b>Deadly electric shock.</b></p> <ul style="list-style-type: none"> <li>∅ The chamber must NOT become wet during operation, cleaning, or maintenance.</li> <li>∅ Do NOT install the chamber in damp areas or in puddles.</li> <li>➤ Set up the chamber in a splash-proof manner.</li> </ul>

The chambers were produced in accordance with VDE regulations and were routinely tested in accordance to VDE 0411-1 (IEC 61010-1).

The inner surfaces become very cold during operation.

 	 <b>CAUTION</b>
	<p><b>Danger of injury by freezing on when touching cold chamber parts during or after operation.</b>  <b>Local frostbite.</b></p> <ul style="list-style-type: none"> <li>∅ Do NOT directly touch the inner surfaces or the charging material during operation.</li> <li>∅ AVOID skin contact with the inner surfaces and accessory equipment.</li> <li>➤ Wear protective gloves when opening the inner doors and during manipulation.</li> </ul>

 	 <b>WARNING</b>
	<p><b>Danger of injury and damages by the chamber tipping over or breakaway of the protruding lower housing cover.</b>  <b>Injuries and damage to the chamber and the charging material</b></p> <ul style="list-style-type: none"> <li>∅ Do NOT climb on the lower housing cover.</li> <li>∅ Do NOT load the lower housing cover with heavy objects while the chamber door is open.</li> </ul>

## 1.8 Intended use

	<p>Following the instructions in this operating manual and conducting regular maintenance work (chap. 24) are part of the intended use.</p>
---	---

**Any use of the chambers that does not comply with the requirements specified in this Operating Manual shall be considered improper use.**

**Other applications than those described in this chapter are not approved.**

### Use

SUFsg ultra-low temperature freezers are technical equipment and intended solely for use at work. They are suitable and designed for safe storage of varied materials at temperatures up to  $-90\text{ °C}$  /  $-130\text{ °F}$ , especially for long-term storage of biological, medical, and chemical samples at constant low temperature. They are suitable for the domains Pharmacy, Medicine, Life Sciences, plastic industry, electronic components, food etc.

Freezers are designed for storage of harmless materials.



In case of foreseeable use of the chamber there is no risk for the user through the integration of the chamber into systems or by special environmental or operating conditions in the sense of EN 61010-1. For this, the intended use of the chamber and all its connections must be observed.

## Requirements for the chamber load



The charging material shall not contain any corrosive ingredients that may damage the machine components made of stainless steel. Such ingredients include in particular acids and halides. Any corrosive damage caused by such ingredients is excluded from liability by the manufacturer.

None of the components of the charging material must be able to form an explosive mixture with air. Any component of the charging material must NOT be able to release toxic gases.

The chamber does not dispose of any measures of explosion protection.

 	 <b>DANGER</b>
	<p><b>Explosion or implosion hazard and danger of poisoning through the introduction of unsuitable loading material.</b></p> <p><b>Poisoning. Serious injury or death from burns and / or explosion pressure.</b></p> <ul style="list-style-type: none"> <li>∅ Do NOT introduce any substance combustible or explosive into the chamber, in particular no energy sources such as batteries or lithium-ion batteries.</li> <li>∅ NO explosive dust or air-solvent mixture in the inner chamber.</li> <li>∅ Do NOT introduce any substance which could lead to release of toxic gases.</li> </ul>

Contamination of the chamber by toxic, infectious or radioactive substances must be prevented

 	 <b>WARNING</b>
	<p><b>Danger of intoxication and infection through contamination of the chamber with toxic, infectious or radioactive substances.</b></p> <p><b>Damages to health.</b></p> <ul style="list-style-type: none"> <li>➤ Protect the interior of the chamber against contamination by toxic, infectious or radioactive substances.</li> <li>➤ Take appropriate measures when bringing in or taking out toxic, infectious or radioactive substances.</li> </ul>

## Medical devices

The chambers are not classified as medical devices as defined by Regulation (EU) No 2017/745.

## Personnel Requirements

Only trained personnel with knowledge of the Operating Manual can set up and install the chamber, start it up, operate, clean, and take it out of operation. Service and repairs call for further technical requirements (e.g. electrical know-how), as well as knowledge of the service manual.

## Installation site requirements

The chambers are designed for setting up inside a building (indoor use).

The requirements described in the Operating Manual for installation site and ambient conditions (Chap. 3.4) must be met.

	<p><b>WARNING:</b> If customer should use a chamber running in non-supervised continuous operation, we strongly recommend in case of inclusion of irrecoverable specimen or samples to split such specimen or samples and store them in at least two chambers, if this is feasible.</p>
---	---

## 1.9 Foreseeable Misuse

Other applications than those described in chap. 1.8 are not approved.

This expressly includes the following misuses (the list is not exhaustive), which pose risks despite the inherently safe construction and existing technical safety equipment:

- Non-observance of Operating Manual
- Non-observance of information and warnings on the chamber (e.g. control unit messages, safety identifiers, warning signals)
- Installation, startup, operation, maintenance and repair by untrained, insufficiently qualified, or unauthorized personnel
- Missed or delayed maintenance and testing
- Non-observance of traces of wear and tear
- Insertion of materials excluded or not permitted by this Operating Manual.
- Non-compliance with the admissible parameters for processing or storing the respective material.
- Installation, testing, service or repair in the presence of solvents
- Installation of replacement parts and use of accessories and operating resources not specified and authorized by the manufacturer
- Bypassing or changing protective systems, operation of the chamber without the designated protective systems
- Non-observance of messages regarding cleaning and disinfection of the chamber.
- Spilling water or cleaning agent on the chamber, water penetrating into the chamber during operation, cleaning or maintenance.
- Cleaning activity while the chamber is turned on.
- Operation of the chamber with a damaged housing or damaged power cord
- Continued operation of the chamber during an obvious malfunction
- Insertion of objects, particularly metallic objects, in louvers or other openings or slots on the chamber
- Human error (e.g. insufficient experience, qualification, stress, exhaustion, laziness)

To prevent these and other risks from incorrect operation, it is recommended to issue operating instructions and Standard operating procedures (SOPs).

## 1.10 Residual Risks

The unavoidable design features of a chamber, as well as its proper field of application, can also pose risks, even during correct operation. These residual risks include hazards which, despite the inherently safe design, existing technical protective equipment, safety precautions and supplementary protective measures, cannot be ruled out.

Messages on the chamber and in the Operating Manual warn of residual risks. The consequences of these residual risks and the measures required to prevent them are listed in the Operating Manual. Moreover, the operator must take measures to minimize hazards from unavoidable residual risks. This includes, in particular, issuing operating instructions.

The following list summarizes the hazards against which this Operating Manual and the Service Manual warn, and specifies protective measures at the appropriate spots:

## **Unpacking, Transport, Installation**

- Sliding or tilting the chamber
- Setup of the chamber in unauthorized areas
- Installation of a damaged chamber
- Installation of a chamber with damaged power cord
- Inappropriate site of installation
- Missing protective conductor connection

## **Normal operation**

- Assembly errors
- Contact with cold surfaces on the housing and on the inside of the door
- Emission of non-ionizing radiation from electrical operating resources
- Contact with live parts in normal state

## **Cleaning and Decontamination**

- Penetration of water into the chamber
- Inappropriate cleaning and decontamination agents
- Enclosure of persons in the interior

## **Malfunction and Damage**

- Continued operation of the chamber during an obvious malfunction or outage of the cooling system
- Contact with live parts during error status

Operation of a unit with damaged power cord

## **Maintenance**

- Maintenance work on live parts.
- Execution of maintenance work by untrained/insufficiently qualified personnel
- Electrical safety analysis during annual maintenance not performed

## **Trouble-shooting and Repairs**

- Non-observance of warning messages in the Service Manual
- Trouble-shooting of live parts without specified safety measures
- Absence of a plausibility check to rule out erroneous inscription of electrical components
- Performance of repair work by untrained/insufficiently qualified personnel
- Inappropriate repairs which do not meet the quality standard specified by the manufacturer
- Use of replacement parts other than original replacement parts
- Electrical safety analysis not performed after repairs



## 1.11 Operating instructions

Depending on the application and location of the chamber, we recommend that the operator of the chamber provides the relevant information for safe operation of the chamber in a set of operating instructions.



Keep these operating instructions with the chamber at all times in a place where they are clearly visible. They must be comprehensible and written in the language of the employees.

## 1.12 Measures to prevent accidents

The operator of the chamber must observe the locally applicable guidelines for operating the chamber and take precautions to prevent accidents

Following measures have been taken by the manufacturer in order to prevent ignition and explosions:

- **Indications of the type plate**

See operating manual chap. 1.6

- **Operating manual**

An operating manual is available for each chamber.

- **Temperature monitoring**

The chamber has a temperature display which can be read from outside.

An additional temperature safety device is built into the chamber. A visual and an audible signal (buzzer) show exceeding of the temperature.

- **Safety, measurement and control devices**

The safety, measuring, and control devices are easily accessible.

- **Electrostatic charge**

The interior parts are grounded.

- **Non-ionizing radiation**

Non-ionizing radiation is not intentionally produced, but released only for technical reasons by electrical equipment (e.g. electric motors, power cables or solenoids). Additionally, the machine has no strong permanent magnets. If persons with active implants (e.g. pacemakers, defibrillators) keep a safe distance (distance of field source to implant) of 30 cm, an influence of these implants can be excluded with high probability.

- **Protection against touchable surfaces**

Tested according to EN ISO 13732-3:2008.

- **Floors**

See operating manual chap. 3.4 for installation

- **Cleaning**

See operating manual chap. 23.

- **Examinations**

UL chambers only: The chamber is certified by Underwriters Laboratories Inc.® according to the standards UL 61010-1, 3<sup>rd</sup> Edition, 2012-05, Rev. 2018-11; CAN/CSA-C22.2 No. 61010-1-12, 3<sup>rd</sup> Edition, Amendment 1:2018, 2012-05, Rev. 2018-11; IEC 61010-2-011:2019; UL 61010-2-011 (IEC 61010-2-011:2016).

## 2. Chamber description

The SUFsg ultra-low temperature freezers were produced with great care using the latest tools for development and production. They were optimized for safe long-term storage of samples in the ultra-low temperature range. You can operate the freezer in a temperature range from  $-90\text{ }^{\circ}\text{C}$  /  $-130\text{ }^{\circ}\text{F}$  up to  $-40\text{ }^{\circ}\text{C}$  /  $-40\text{ }^{\circ}\text{F}$ .

The freezers are available for several different voltages.

### **Lockable protective flap for the main power switch (option)**

An additional locking system with key for the freezer's main power switch is optionally available.

### **Controller and safety**

The efficient chamber controller is equipped with a multitude of operating functions, in addition to recorder and alarm functions.

Temperature setting is accurate to a tenth of a degree. The controller is mounted at the optimal height for operation.

The controller offers an error diagnostics system generating audible and visual warning and alarm messages.

In case of a power failure, alarm function and control remain active during 72h through the battery-buffered alarm system. The controller provides password protection for the setting menus.

The controller monitors ambient temperature and issues an alarm if it exceeds an adjustable value.

Thanks to the standard overtemperature safety device, the set temperature is maintained also in case of a controller failure.

In case of power failure at  $-80\text{ }^{\circ}\text{C}$  /  $-112\text{ }^{\circ}\text{F}$ , a temperature of  $-60\text{ }^{\circ}\text{C}$  /  $-76\text{ }^{\circ}\text{F}$  will not be exceeded in an empty freezer for at least 3.5 hours, in a loaded freezer (measured with a 30 kg / 66 lb water load) for approx. 7 hours.

### **Housing**

The inner chamber and the inside of the insulated outer door are made of stainless steel (German material no. 1.4016, US equivalent AISI 430). The housing including all corners and edges is plastic coated. The inner surfaces are smooth and therefore easy to clean. Easy front access permits filter cleaning without tools. Three 28 mm access port serve to introduce a sensor cable of a measuring device, the upper left one (6a) also to connect the optional CO<sub>2</sub> emergency cooling

The buildup of ice in the door area is minimal due to perfect closing of the inner and outer doors. Precise spatial distribution of the cold in the interior ensures storage of all samples at an identical storage temperature. The prevention of thermal bridges protects against defrosting. The combination of vacuum insulation panels (VIP technology) and CFC-free polyurethane foaming maximizes the insulation capacity.

The freezer has two compartment doors. You can insert stainless steel shelves and make optimum use of the interior. You can flexibly arrange the shelves to use the interior in a variable and optimum manner. Inventory racks (stainless steel storage racks with cryo boxes, chap. 22) are optionally available.

Castors with locks serve to move the freezer.

## **Cooling system**

The powerful, energy-efficient and low-noise refrigerating machine uses the environmentally friendly "green" refrigerants R290 (propane) und R170 (ethane). They are completely free of HCFCs (hydrochloro-fluorocarbons) and CFCs (chlorofluorocarbon).

Control of the two-stage refrigerating machine: The 1<sup>st</sup> stage cooling immediately turns on. In addition, the 2<sup>nd</sup> stage cooling turns on depending on the temperature.

## **Battery-buffered alarm system**

The freezer is equipped with a rechargeable battery (12 V, 7.2 Ah). Battery voltage is regularly monitored. An alarm indicates too low battery voltage. You can check the battery voltage in the controller menu.

An error diagnostics system monitors the chamber functions and generates audible and visual warning and alarm messages. E.g., the door is monitored for being closed.

The CO<sub>2</sub> emergency cooling (option, chap. 20) offers additional refrigeration, i.e., following introduction of a heat load, in case of a power failure or failure of the cooling system.

## **Data monitoring and recording**

The chamber is regularly equipped with a zero-voltage relay alarm output (chap. 14.4.7) and optionally with an analog output (chap. 21.2) for integration into customer systems.

The freezer is regularly equipped with an Ethernet interface (chap. 21.1) for computer communication, enabling monitoring via a network.

## 2.1 Chamber overview

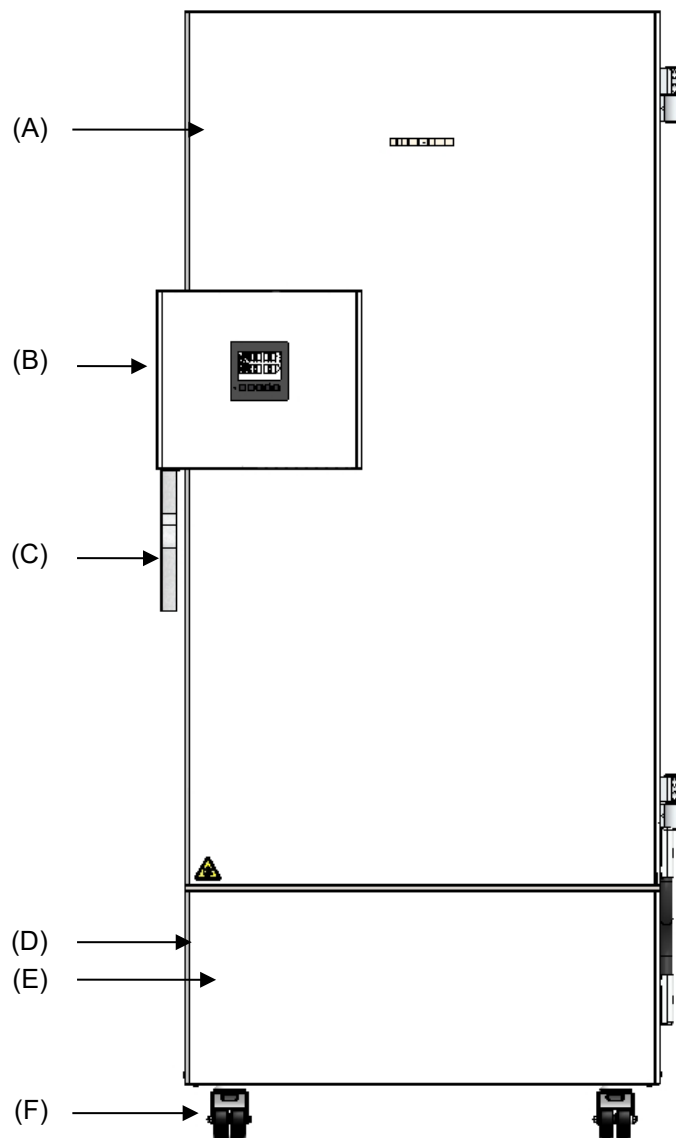

Figure 4: Ultra-low temperature freezer SUFsg (example SUFsg 7001), front view

- (A) Outer door
- (B) Door lock and controller housing (description chap. 2.2)
- (C) Door handle
- (D) Compressor housing
- (E) Cover flap (checking and cleaning / replacing the filter chap. 24.2.1)
- (F) Castors (front castors lockable by breaks)

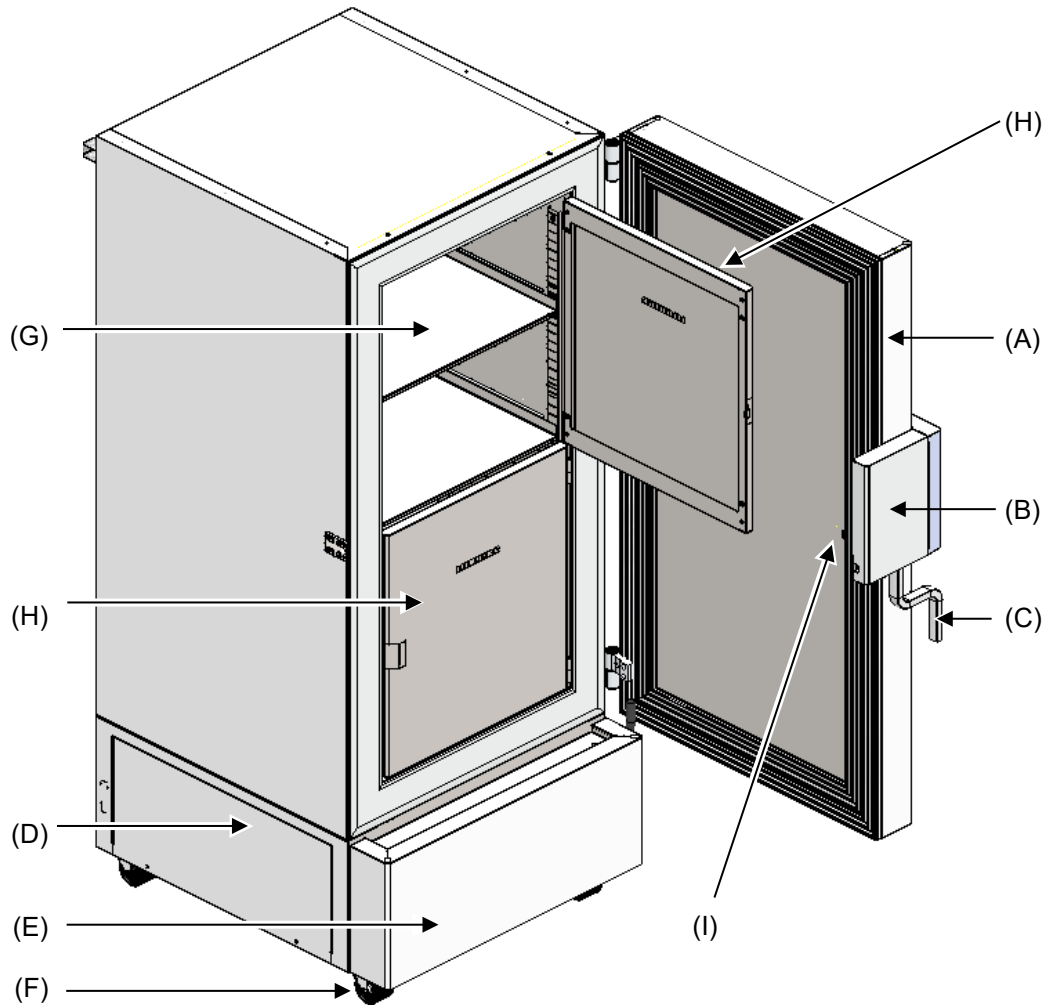

Figure 5: Ultra-low temperature freezer SUFsg 7001, open

- (A) Outer door
- (B) Door lock and controller housing (description chap. 2.2)
- (C) Door handle
- (D) Compressor housing
- (E) Cover flap (checking and cleaning / replacing the filter chap. 24.2.1)
- (F) Castors (front castors lockable by breaks)
- (G) Compartment with variable shelf
- (H) Compartment door
- (I) Pressure compensation valve (inside of the door behind the door lock and controller housing)

## 2.2 Door lock and controller housing

The controller operator panel is integrated in the freezer's door lock and controller housing (B).

A door handle (C) serves to open and close the chamber door.

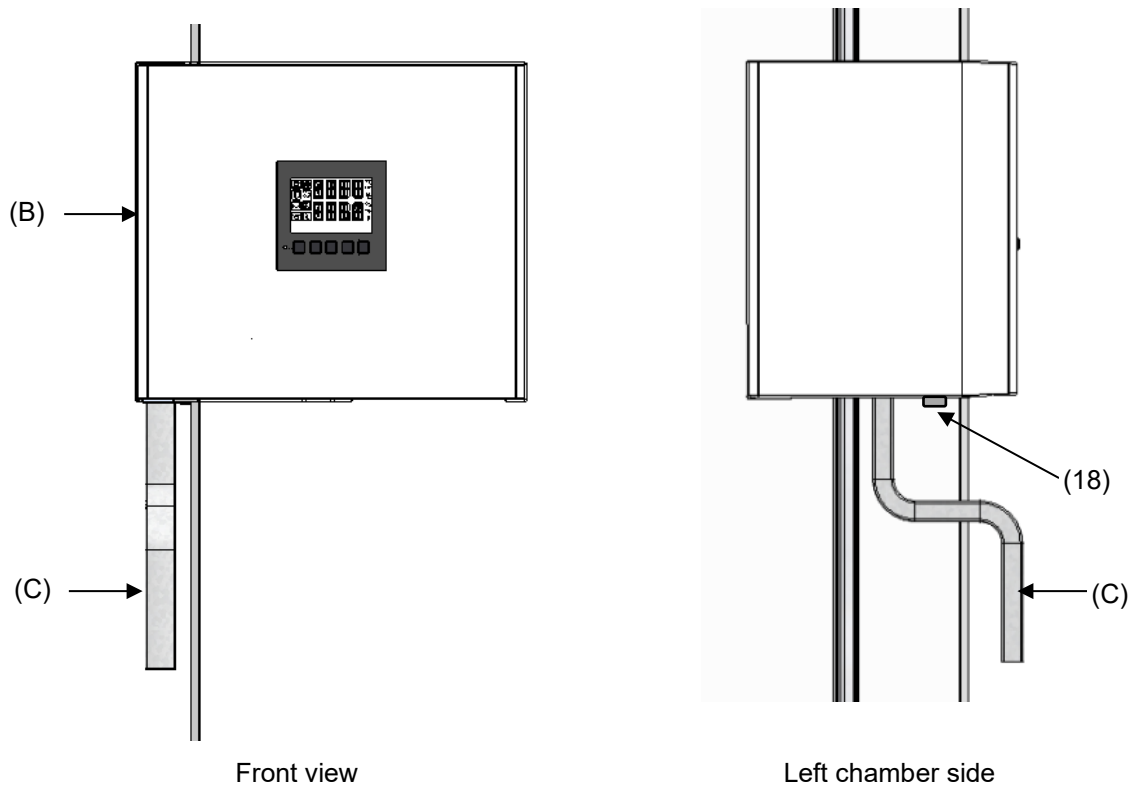

Figure 6: Door lock and controller housing with controller operator panel and door handle

- (B) Door lock and controller housing
- (C) Door handle
- (18) Door lock

### 2.2.1 Operating the door lock

The door lock (18) is located on the left side of the chamber in front of the door handle. Two keys are included. To lock the door lock, turn the key clockwise. The key can be removed in both positions (open / locked).

Note: Be sure to remove the key before opening the door. Otherwise the door lock may be damaged.

	<b>NOTICE</b>
	<p><b>Danger of damage when opening the door with the key inserted.</b> <b>Damage to the door lock.</b></p> <p>➤ Remove the key before opening the door with the door handle.</p>

## 2.3 Main power switch

The main power switch is located on the bottom right side of the chamber.

In addition, a lockable protective flap covering the main power switch is optionally available. It can be unlocked with a key and then removed.

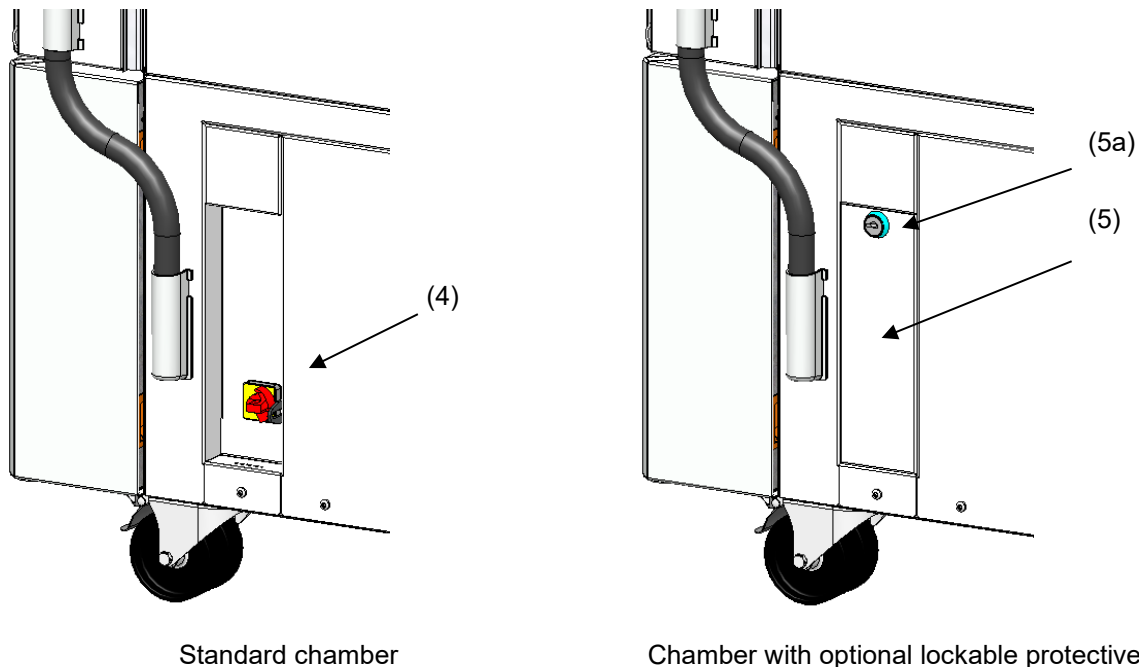

Figure 7: Position of the main power switch and the lockable protective flap (option) on the right side of the chamber

- (4) Main power switch
- (5) Lockable protective flap (option)
- (5a) Key lock of the optional lockable protective flap



Figure 8: Main power switch (4) on the right side of the chamber

## 2.4 Chamber rear

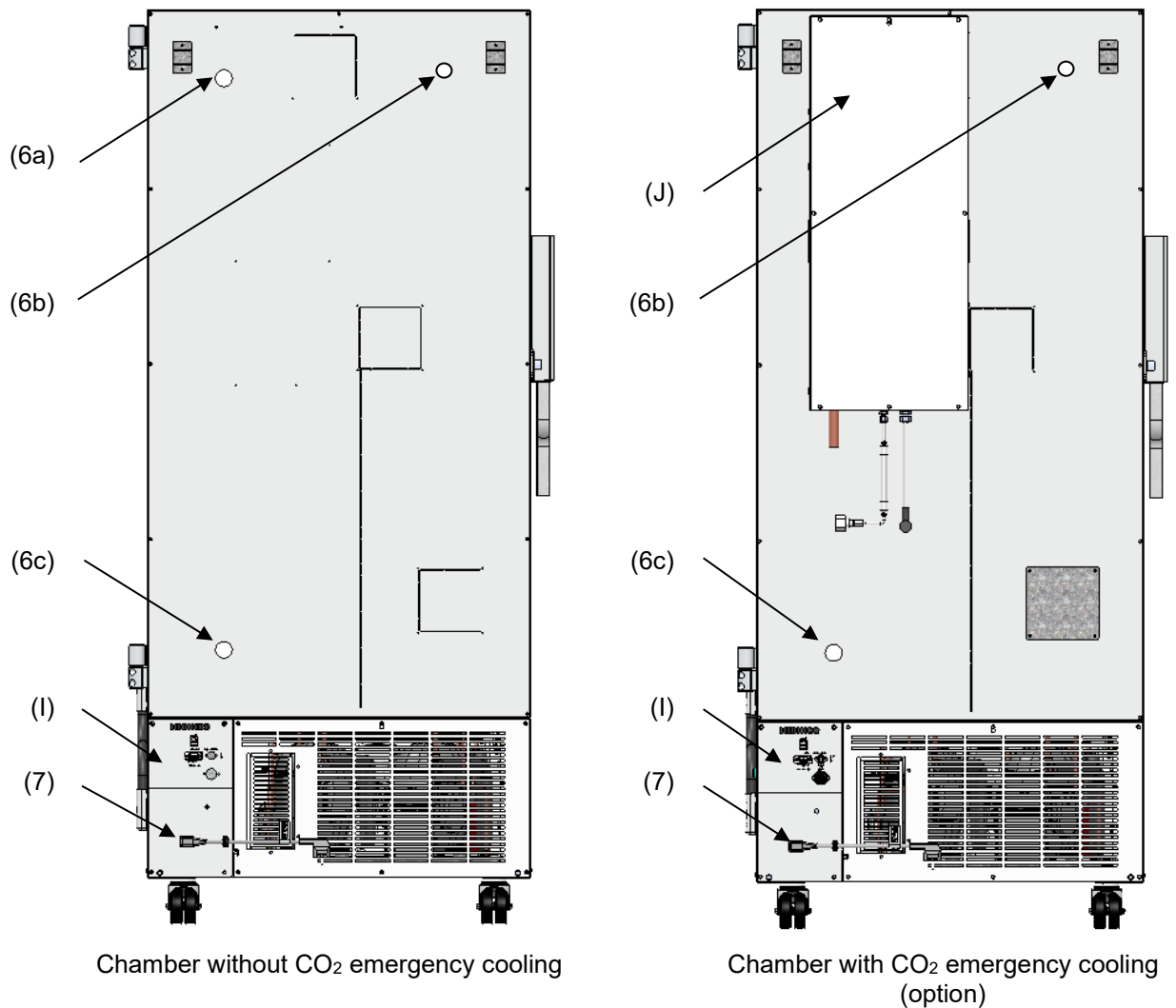

Figure 9: Chamber rear

- (6a) 28 mm access port to connect the der CO<sub>2</sub> emergency cooling (option) or for cable of a supplementary measuring device
- (6b),(6c) 28 mm access ports, e.g., for cable of a supplementary measuring device
- (7) Connecting socket for IEC connector plug with strain relief
- (l) Connection panel
- (J) CO<sub>2</sub> emergency cooling (option, chap. 20)



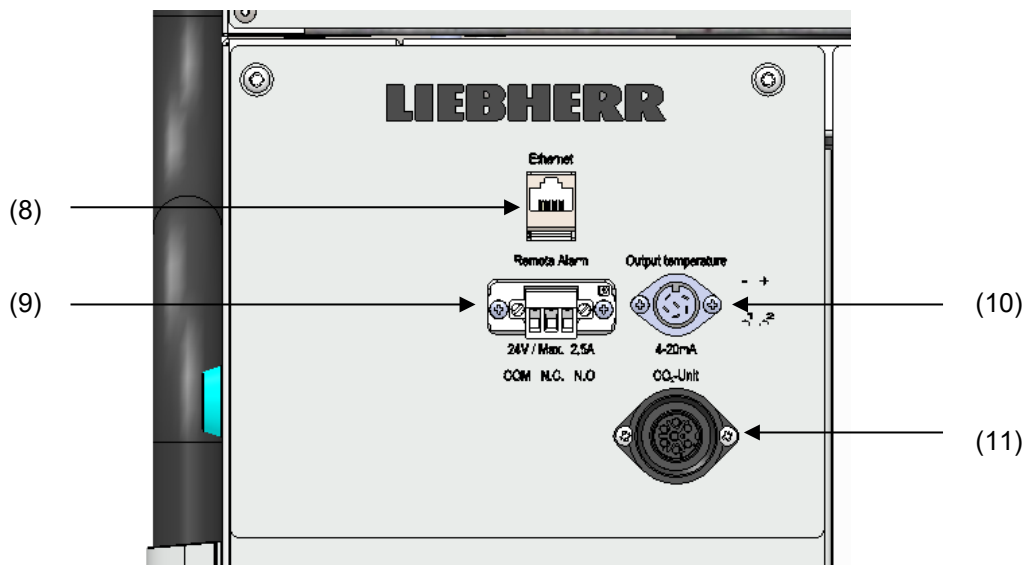

Figure 10: Connection panel (I) on the chamber rear, with options

- (8) Ethernet interface (Chap. 21.1)
- (9) Connection socket for zero-voltage relay alarm contact (chap. 14.4.7)
- (10) Connection socket for analog output 4-20 mA (option, chap. 21.2)
- (11) Connection socket for the electrical connection of the CO<sub>2</sub> emergency cooling (option, chap. 20)

## 2.5 Doors

### 2.5.1 Outer door

The outer door must be closed while the chamber is operating normally in order to ensure stable conditions in the inner chamber.



Delay time for the door open alarm:  
After closing the outer door, the door open alarm is switched off for a programmable delay time (factory setting: 1 minute).

### 2.5.2 Compartment doors

The freezer interior is divided into 4 compartments, which are isolated against the surrounding with two doors. That permits bringing in or removing the samples of an individual compartment without remarkably affect temperature in the other compartments.

The compartment doors remain closed by magnetism when opening the outer door without need for closing them mechanically.



Open the inner doors as shortly as possible to avoid a temperature rise inside the freezer. The maximum angle of aperture is 100°.

For the additional thermal insulation and sealing of the interior compartment doors, you can order the option "compartment doors, insulated". For this purpose, the compartment doors are filled with foam and thus additionally thermally insulated.

## 3. Completeness of delivery, transportation, storage, and installation

### 3.1 Unpacking, and checking equipment and completeness of delivery

After unpacking, please check the chamber and its optional accessories, if any, based on the delivery receipt for completeness and for transportation damage. Inform the carrier immediately if transportation damage has occurred.

	 <b>CAUTION</b>
	<p><b>Risk of injury and damages by sliding or tilting of the chamber due to improper lifting.</b></p> <p><b>Injuries, damage to the chamber.</b></p> <ul style="list-style-type: none"> <li>∅ Do NOT lift the chamber using the door, the door lock and controller housing or the lower housing.</li> <li>∅ Do NOT lift the chamber by hand.</li> <li>∅ If possible, avoid transporting the chamber horizontally. It may be transported lying down ONLY on the hinge side or on its back, but must then stand upright for at least 24 hours before turning on.</li> <li>➤ Lift the chamber using technical devices (fork lifter) from the pallet. Set the fork lifter laterally or from the rear in the middle of the chamber. Make sure to place all the lateral supports of the chamber on the forks (check: the fork protrudes at the opposite chamber side).</li> <li>➤ Wear suitable shoes (safety shoes).</li> </ul>

The final tests of the manufacturer may cause traces of the shelves on the inner surfaces. This has no impact on the function and performance of the chamber.

Please remove any transportation protection devices and adhesives in/on the chamber and on the doors and remove the operating manuals and accessory equipment.

	Remove any protective lamination sheet on the inner metal surfaces prior to commissioning.
---	--

	Wait at least 8 hours following transport with technical devices (chap. 3.2.2) before start-up.
---	---

If you need to return the chamber, please use the original packing and observe the guidelines for safe lifting and transportation (chap. 3.2).

For disposal of the transport packing, see chap. 25.1.

#### Scope of delivery

- Ultra-low temperature freezer SUFsg
- 3 shelves and 12 shelf holders with 6 screws
- Plug for the zero-voltage relay alarm output (connected)
- Set of 2 spacers for rear wall distance.
- Operating manual (set)
- Water connection sets with chambers with water cooling

## 3.2 Guidelines for safe lifting and transportation

### 3.2.1 Moving the freezer inside a building

Before moving the freezer unlock the front castors. The castors are designed only for moving the freezer inside a building. This is possible only on a floor without joints (e.g. no tiles) and when avoiding shocks. In this case, the freezer must not be empty (max. load see technical data, chap. 26.3).

If you want to move the chamber across a large door threshold or into an elevator to change the floor, empty the freezer and put all shelves on the bottom of the interior.

If you incline the chamber by less than 5°, you can directly turn it on after moving (at least 10 minutes after turning off). Otherwise, wait at least 8 hours until putting it into operation again.

As soon as the chamber has reached its destination, lock the front castors.



Wear suitable shoes (safety shoes) when moving the freezer.

Over very short distances (within reach of the power cable), you can move the freezer while operating.

If you turned off the chamber (turning off at the main power switch, pulling the power plug), wait at least 10 minutes after moving until you turn on again the chamber in order to protect the refrigeration machine against damage.



### NOTICE

**Risk of damage to the refrigeration system due to too quick restart of the refrigeration machine after moving the chamber.**

**Damage to the chamber.**

➤ After moving the freezer wait 10 minutes before turning on the freezer again.

To move the freezer through narrow passages (doors, narrow corridors), open the chamber door:

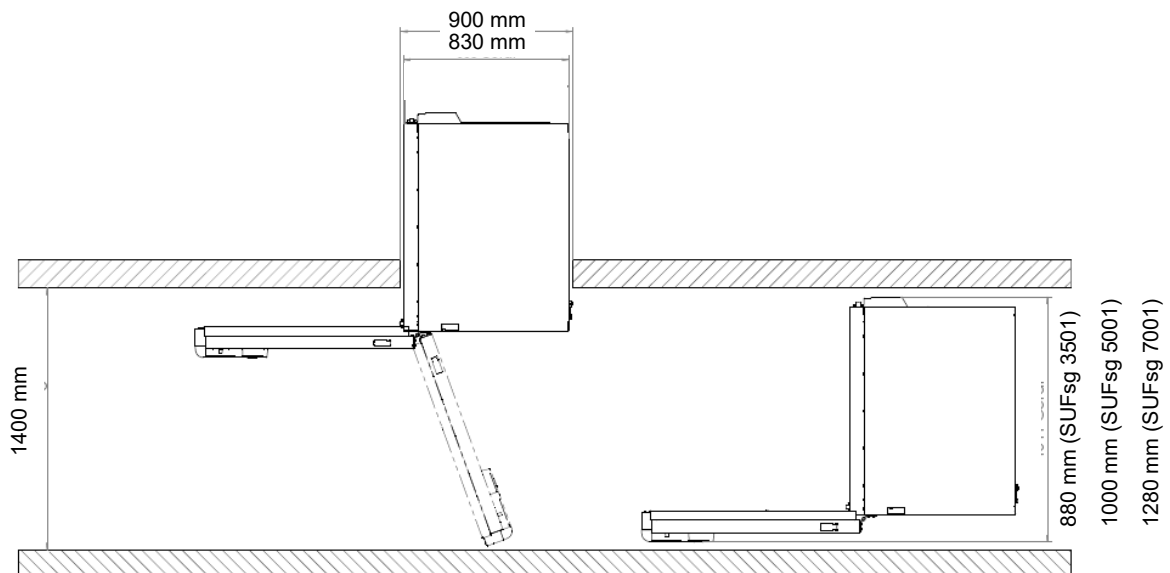





Figure 11: SUFsg with open chamber door

For transport outside a building use technical equipment (chap. 3.2.2).

## 3.2.2 Transport outside a building

Before moving the chamber unlock the front castors. The castors are designed only for moving the chamber inside a building (respect the information given in chap. 3.2.1).

After operation, please observe the guidelines for temporarily decommissioning the chamber (chap. 25.2).

 	 <b>CAUTION</b>
	<p><b>Risk of injury and damages by sliding or tilting of the chamber due to improper transportation.</b></p> <p><b>Injuries, damage to the chamber.</b></p> <ul style="list-style-type: none"> <li>⊘ Do NOT lift or transport the chamber using the door, the door lock and controller housing or the lower housing.</li> <li>⊘ Do NOT lift the chamber by hand</li> <li>⊘ If possible, avoid transporting the chamber horizontally. It may be transported lying down ONLY on the hinge side or on its back, but must then stand upright for at least 24 hours before turning on.</li> <li>➤ Transport the chamber only in its original packaging.</li> <li>➤ Secure the chamber with transport straps for transport.</li> <li>➤ Place the shelves on top of each other on the bottom of the interior.</li> <li>➤ Lift the chamber using technical devices (fork lifter) and place it on the transport pallet. Set the fork lifter laterally or from the rear in the middle of the chamber. Make sure to place all the lateral supports of the chamber on the forks (check: the fork protrudes at the opposite chamber side).</li> <li>➤ Transport chambers ONLY with the original transport pallet. Set the fork lifter only to the pallet. Without the pallet the chamber is in imminent danger of overturning</li> <li>➤ Wear suitable shoes (safety shoes).</li> </ul>

- Permissible ambient temperature range for transport: -20 °C / -4 °F to +60 °C / 140 °F.

You can order transport packing and rolling pallets for transportation purposes from the manufacturer.

	Wear suitable shoes (safety shoes) during transport.
---	--

	Following transport, wait at least 8 hours until start-up.
---	--

### 3.3 Storage

Intermediate storage of the chamber is possible in a closed and dry room. Observe the guidelines for temporary decommissioning (chap. 25.2).

- Permissible ambient temperature range for storage:  $-20\text{ °C} / -4\text{ °F}$  to  $+60\text{ °C} / 140\text{ °F}$ .
- Permissible ambient humidity: max. 70% r.h., non-condensing

Secure the chamber against unintentional rolling by locking the front castors.

The freezer must stand upright in order to avoid oil running out of the engine casing and resulting damages to the cooling system. Max. angle of inclination:  $10^\circ$ .

When after storage in a cold location you transfer the chamber to its warmer installation site, condensation may form in the inner chamber or on the housing. Before start-up, wait at least one hour until the freezer has attained ambient temperature and is completely dry. According to the type of transport that has taken place (chap. 3.2) you may have to wait at least 8 hours until start up.

### 3.4 Location of installation and ambient conditions

The freezer is designed for setting up inside a building (indoor use). Set up the chamber on a flat, even surface, free from vibration and in a well-ventilated, dry location. Lock the front castors and align the chamber using a spirit level. The site of installation must be capable of supporting the chamber's weight (see technical data, chap. 26.3).

	NOTICE
	<p><b>Danger of overheating due to lack of ventilation.</b>  <b>Damage to the chamber.</b></p> <ul style="list-style-type: none"> <li>⊘ Do NOT install the chamber in unventilated recesses.</li> <li>➤ Ensure sufficient ventilation for dispersal of the heat.</li> <li>➤ Make sure that all fan openings in the housing or in the construction intended for installation are uncovered.</li> <li>➤ Observe the prescribed minimum distances when installing the chamber.</li> </ul>

	NOTICE
	<p><b>Danger to the environment by leakage of refrigerant in the event of a chamber defect.</b>  <b>Alteration of the environment.</b></p> <ul style="list-style-type: none"> <li>➤ Ensure sufficient ventilation of the installation site.</li> </ul>

- Permissible ambient temperature range for operation:  $+16\text{ °C} / 60.8\text{ °F}$  to  $+32\text{ °C} / 89.6\text{ °F}$ . At elevated ambient temperature values, fluctuations in temperature can occur.

	<p>The ambient temperature should not be substantially higher than the indicated ambient temperature of <math>+25\text{ °C} / 77\text{ °F}</math> to which the specified technical data relate. For other ambient conditions, deviations from the indicated data are possible.</p>
---	--

Prevent the freezer from sucking warm air from other devices.

	<p>Avoid direct solar radiation on the chamber. Do not place the freezer in direct vicinity of chambers with a high heat emission.</p>
---	--

- Permissible ambient humidity: 70% r.h. max., non-condensing.
- Installation height: max. 2000 m / 6561.7 ft above sea level.

## Minimum distances:

- between several chambers: 250 mm / 9.84 in
- Wall distance, rear: 100 mm / 3.94 in (spacer is supplied, see chap. 4.2)
- Wall distance, laterally, on the side without door hinge: 100 mm / 3.94 in
- Wall distance, laterally, on the side with door hinge: 240 mm / 9.45 in.
- Spacing above the chamber: 100 mm / 3.94 in

Ventilation openings must not be blocked. Ensure a distance of at least 100 mm / 3.94 in to the ventilation openings on the freezer's front and rear.

The freezer must stand upright in order to avoid oil running out of the engine casing and resulting damages to the cooling system. Max. angle of inclination: 10°.



To completely separate the chamber from the power supply, you must disconnect the power plug. Install the chamber in a way that the power plug is easily accessible and can be easily pulled in case of danger.

With an increased amount of dust in the ambient air, clean the condenser fan (by suction or blowing) several times a year. Check the condenser air filter frequently and clean it if necessary (chap. 24.2.1).

Avoid any conductive dust in the ambience according to the chamber layout complying with pollution degree 2 (IEC 61010-1).

For the user there is no risk of temporary overvoltages in the sense of EN 61010-1:2010.

Do NOT install or operate the freezer in potentially explosive areas.



**DANGER**

**Danger of explosion due to combustible dusts or explosive mixtures in the vicinity of the chamber.**

**Serious injury or death from burns and / or explosion pressure.**

⊘ Do NOT operate the chamber in potentially explosive areas.

➤ KEEP combustible dust or air-solvent mixtures AWAY from the chamber.

For freezers with water cooling:



To avoid any possible water damage, provide a floor drain at the location of the chamber. Select a suitable installation site to avoid any consequential damage by splashing water.

## 4. Installation and connections

### 4.1 Operating instructions

Depending on the application and location of the chamber, we recommend that the operator of the freezer provides the relevant information for safe operation of the chamber in a set of operating instructions.



Keep these operating instructions with the chamber at all times in a place where they are clearly visible. They must be comprehensible and written in the language of the employees.

### 4.2 Spacers for rear wall distance

Please fix both spacers with the supplied screws at the chamber rear. This serves to ensure the prescribed minimum distance to the rear wall of 100 mm / 3.94 in.

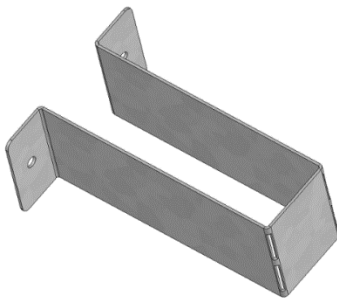

Figure 12: Spacer for rear wall distance

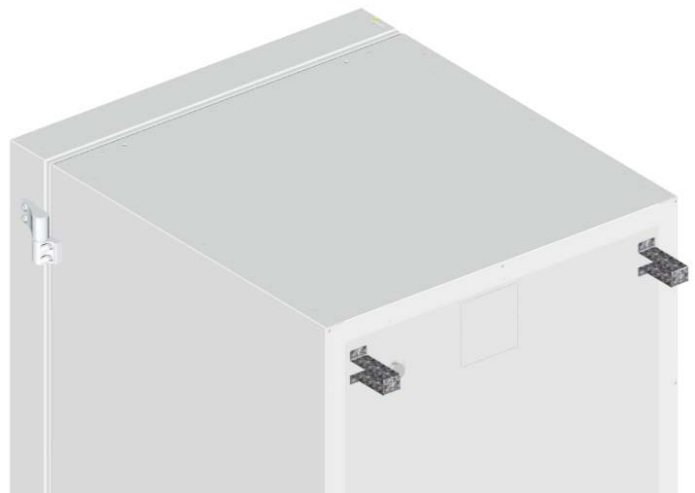

Figure 13: Rear chamber with mounted spacers

### 4.3 Support feet (SUFsg 3501 only)

To prevent tipping, it is necessary to extend the support feet on the front side under the door by turning them down after the device has been set up

Make sure to turn up the two support feet again before moving the device.

## 4.4 Adjustable shelves

The scope of delivery comprises three adjustable shelves. You can mount them and further optional shelves in different positions of the lateral walls in 24 mm / 1 inch steps. In standard position, the shelves are placed with a distance of 310mm / 12.2 in, forming the bottom of the compartments, thus making available the maximum space for optional inventory systems.

It is required to fix the adjustable shelves in order to avoid that a person could be locked in the freezer. To remove a shelf, remove the screws, lift and incline the shelf and then pull it forward.

### Mounting the adjustable shelves:

- Insert the shelf holders at the desired height into shelf holder bars.
- Insert the shelves and screw them with a Phillips screwdriver to the shelf holders

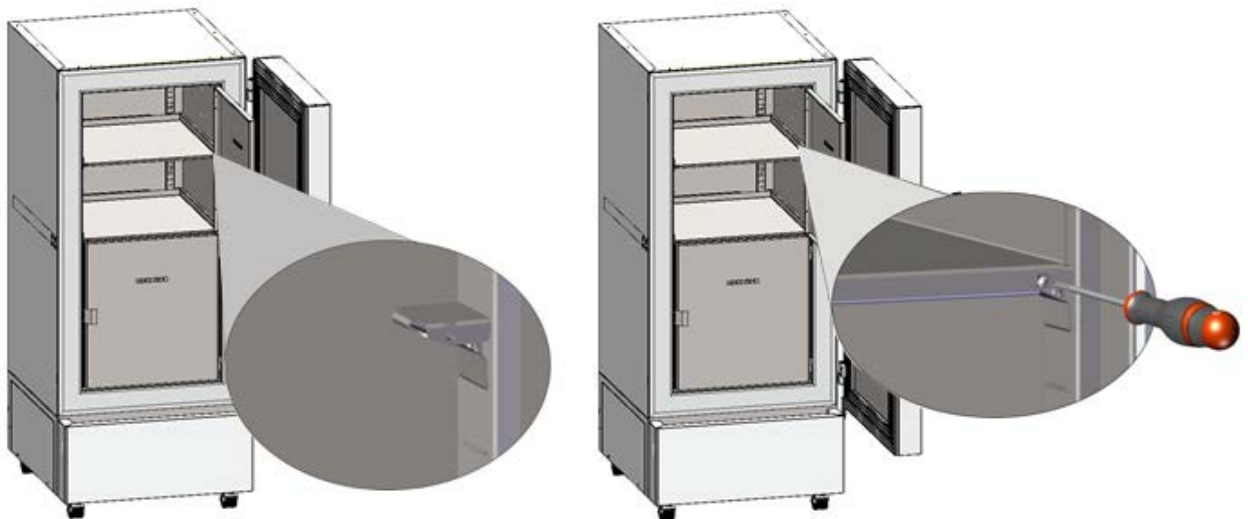
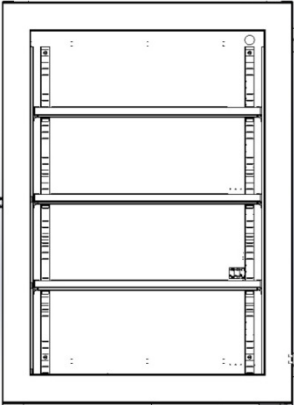
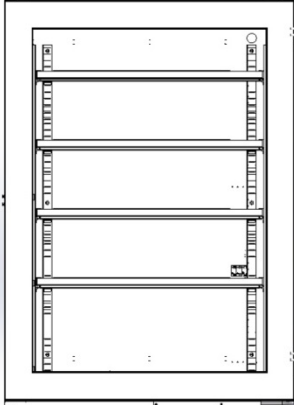
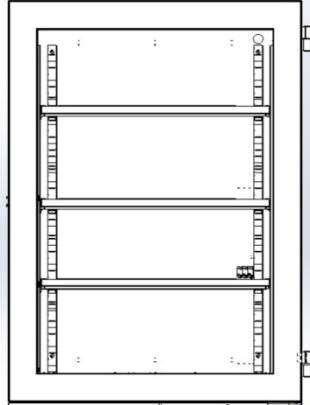

Figure 14: Inserting the shelf holders and screwing the shelves to the shelf holders



For optimal use of space, we recommend the following shelf positions:

<p>Position of 3 shelves to obtain 4 compartments with equal ceiling height</p>	<p>Position of 4 shelves (1 x optional) to obtain 5 compartments with equal ceiling height</p>	<p>Position of 3 shelves to obtain the maximum sample storage space: 2 compartments with a ceiling height of 334 mm / 13.15 in (for racks 4x6) and 2 compartments with a ceiling height of 279 mm / 11 in (for racks 4x5)</p>
		
<p>Insert the shelf holders into the following positions of the shelf holder bar (starting from the bottom): 18, 35, 53</p>	<p>Insert the shelf holders into the following positions of the shelf holder bar (starting from the bottom): 13, 29, 42, 58</p>	<p>Insert the shelf holders into the following positions of the shelf holder bar (starting from the bottom): 21, 36, 53</p>

### Permitted shelf loads:

Chamber size		SUFsg 3501	SUFsg 5001	SUFsg 7001
Permitted load of individual shelf (regular)	kg / lbs	40 / 88	50 / 110	50 / 110
Permitted total load of all shelves (regular)	kg / lbs	160 / 353	200 / 441	200 / 441

If the upper shelf is loaded with maximum load, a minimum distance of 24 cm / 9.4 in to the ceiling of the interior must be observed. Therefore, do not insert the shelf above position 59 (counted from bottom) of the shelf holder bar.

## 4.5 Connections of cooling water for chambers with water cooling

The water cooling reduces the heat, which is emitted during cooling operation to the ambient air. An enclosure inside the chamber contains the connection kit for the cooling water inlet and outlet.

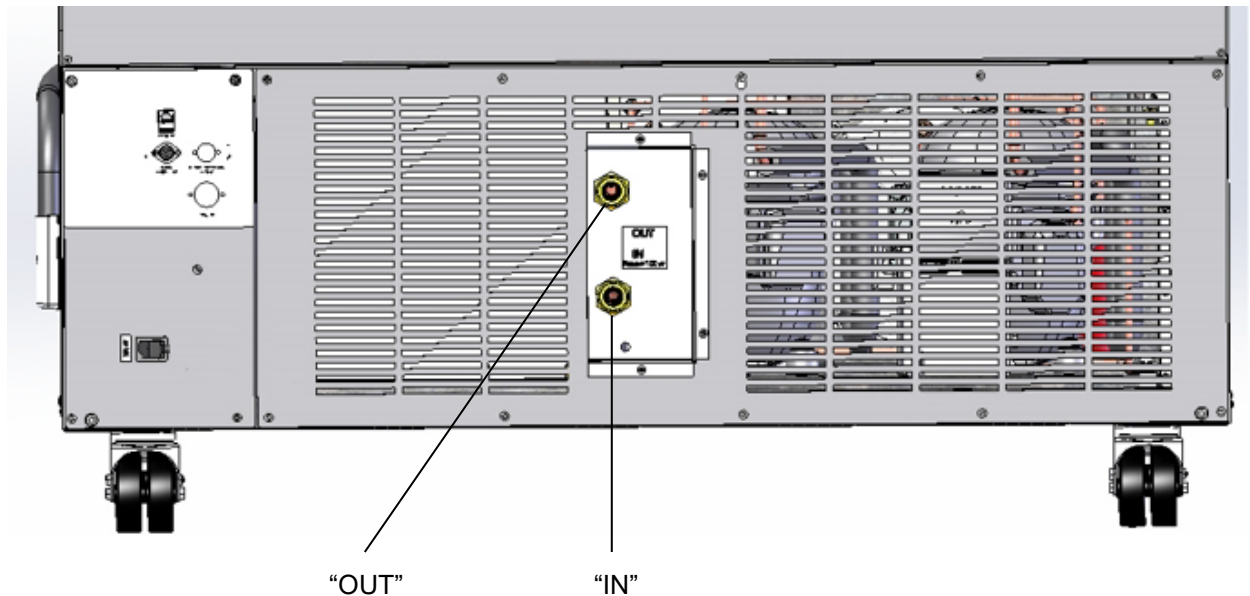

Figure 15: Connections of cooling water on the chamber rear (chambers with water cooling), example SUFsg 7001,H72

“IN” connection for cooling water inlet with external thread 3/4“ and internal thread 3/8“

“OUT” connection for cooling water outlet with external thread 3/4“ and internal thread 3/8“

### 4.5.1 Connection of cooling water outlet for water cooling

Fasten the 1/2“ cooling hose to the connection of cooling water outlet “OUT” on the chamber rear. Observe the following points:

- You can use a part of the supplied water hose for the cooling water outlet. In case another hose is used, it must be permanently resistant against max. 50 °C / 122 °F and pressure-resistant up to 10 bar.
- Put the hose on the hose nozzle with screwing and secure it with one of the four supplied hose clamps. Connect the hose nozzle to the connection “OUT” and screw on the union nut.
- For the hose connection to the domestic water connection, we recommend to also use the supplied hose nozzle with screwing and secure it with one of the four supplied hose clamps.
- Before turning on the chamber, check the connection for leaks.

The temperature of the effluent cooling water is 27 °C up to 29 °C on account of the chamber’s construction.

## 4.5.2 Connection of cooling water inlet for water cooling



Connect the cooling water outlet **before** connecting the cooling water inlet.

Requirements for the cooling water:

- Water type: cooling water, air conditioning water, tap water
- Water intake temperature: 8 °C / 46.4 °F up to 23 °C / 73.4 °F
- pH value 4 up to 8
- Water hardness of max. 142.8 mg/l (ppm) = 10 English (Clark) degrees = 8.32° grains per U.S. gallon = 1.4285 mmol/l.
- Particle size < 100 µm
- Connection pressure 1 bar up to 10 bar overpressure
- Pressure difference between inlet and outlet: at least 0,2 bar; 0,5 bar recommended. A higher pressure difference can result in flow noise.
- The water inlet and outlet should be provided with a shut-off slide or water-tap.
- Return temperature: 27 °C up to 29 °C (pre-set on the control valve of the SUFsg)

### Water demand:

- Average 10-50 l/h, depending on the intake temperature
- Short-term (duration up to 2 minutes) up to 400 l/h



The manufacturer is NOT responsible for the water quality at the user's site. Any problems and malfunctions that might arise following use of water of deviating quality is excluded from liability by the manufacturer. This includes in particular a high particle content, which may result in blockage of the water flow control valve. The warranty becomes void in the event of use of water of deviating quality.

Fasten the 1/2" cooling hose to the connection of cooling water outlet "IN" on the chamber rear. Observe the following points:

- You can use a part of the supplied water hose for the cooling water inlet. In case another hose is used, it must be pressure-resistant up to 10 bar.
- Put the hose on the hose nozzle with screwing and secure it with one of the four supplied hose clamps. Connect the hose nozzle to the connection "IN" and screw on the union nut.
- For the hose connection to the domestic water connection, we recommend to also use the supplied hose nozzle with screwing and secure it with one of the four supplied hose clamps.
- Before turning on the chamber, check the connection for leaks.

Water supply is automatically effected via the water connection "IN".

## 4.5.3 Connection kit for cooling water

The ultra-low temperature freezer with water cooling comes with a connection kit. It consists of the following:

- Hose burst protection device
- 4 Hose nozzles with screwing (union nut)
- 4 hose clamps
- 6m water hose 1/2", divisible for inlet and outlet, approved for max. 15 bar, max. 95 °C

## Protection principle of the hose burst protection

The hose burst protection device serves to protect the environment against flooding caused by burst water hoses. It is intended for the operation of the device at a tap water line. If the freezer is operated in a cycle of cooling water or air conditioning water, the user should check whether the hose burst protection device provides sufficient protection. This depends mainly on a sufficient medium pressure in the system.

Whenever a strong water flow of approx. 18 l / min. occurs, e.g. caused by a burst water hose, a valve automatically cuts off the water supply, which can be heard as a clicking noise. The water supply now remains shut until it is manually released.

## Assembly:

Screw the hose burst protection device onto a water tap with a G $\frac{3}{4}$  inch right turning thread connection. The connection is self-sealing. Establish the connection between the safety kit and the chamber with a part of the supplied hose. Protect both ends of the hose by the supplied hose clamps.

We recommend connecting the hose as the last step in order to avoid twisting the hose while screwing on the safety kit.

Open the water tap slowly in order to avoid actuating the hose burst protection device.

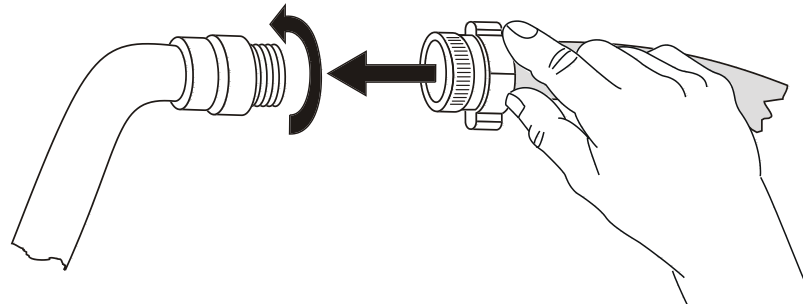

Figure 16: Assembly of the connection kit

## Release of the reflux protection device:

In case the burst protection device has interrupted the water supply, first find the reason and remove it as necessary. Close the water tap. Release the valve by a half left-turn of the upper knurled part. You can hear the release of the valve as a clicking noise. Tighten the burst protection device against the water tap by a right turn. Open the water tap slowly afterwards.

## Maintenance of the assembly of the hose burst protection device:

Calcification can impair valve function. We recommend an annual inspection by a skilled plumber. The plumber should remove the safety kit to check the valve by hand for proper function and calcification or blockage.

<b>NOTICE</b>	
	<p><b>Danger of impairment of the valve function due to calcification.</b> <b>Damage to the chamber.</b></p> <ul style="list-style-type: none"><li>➤ Have a plumber inspect the valve annually.</li><li>➤ Remove calcifications by citric acid or acetic acid solutions.</li><li>➤ Continue by testing the function and tightness of the mounted unit.</li></ul>

Check: Quickly open the water tap while there is no chamber connected – the valve should cut off the water flux without any delay.



## 4.6 Electrical connection

The SUFsg ultra-low temperature freezers are supplied ready for connection and come with an IEC connector plug.

An internal overload release protects the freezer against excess-current.

Model	Plug of the power cable	Nominal voltage +/- 10% at the indicated power frequency	Current type	Fuse
SUFsg 3501,001 SUFsg 5001,001 SUFsg 7001,001 SUFsg 5001,H72 SUFsg 7001,H72	Grounded plug	230 V at 50 Hz	1N~	10 A
SUFsg 3501,137 SUFsg 5001,137 SUFsg 7001,137	NEMA 5-15P	115 V at 60 Hz	1N~	15 A
SUFsg 5001,123 SUFsg 7001,123	NEMA 6-15P	208-230 V at 60 Hz	2~	10 A

- The domestic socket must also provide a protective conductor. Make sure that the connection of the protective conductor of the domestic installations to the chamber's protective conductor meets the latest technology. The protective conductors of the socket and plug must be compatible!

	 <b>DANGER</b>
	<p><b>Electrical hazard due to missing protective conductor connection.</b> <b>Deadly electric shock</b></p> <ul style="list-style-type: none"> <li>➤ Make sure that the chamber's power plug and the power socket match and securely connect the electrical protective conductors of the chamber and the house installation.</li> </ul>

- Only use original connection cables from the manufacturer.  
UL chambers: Use only a UL Listed Power supply cord (UL category ELBZ), SJT 3x14 AWG (2.08 mm<sup>2</sup>); C13L. For outside USA use a certified power supply cord according to national requirements.
- Prior to connection and start-up, check the power supply voltage. Compare the values to the specified data located on the chamber's type plate (located on the left-hand side of the chamber, bottom right-hand, chap. 1.6).

	<b>NOTICE</b>
	<p><b>Danger of incorrect power supply voltage due to improper connection.</b> <b>Damage to the chamber.</b></p> <ul style="list-style-type: none"> <li>➤ Check the power supply voltage before connection and start-up.</li> <li>➤ Compare the power supply voltage with the data indicated on the type plate.</li> </ul>

- Observe a sufficient current protection according to the number of freezers that you want to operate. We recommend the use of a residual current circuit breaker.
- When connecting, please observe the regulations specified by the local electricity supply company and as well as the local or national electrical regulations
- Pollution degree (acc. to IEC 61010-1): 2
- Over-voltage category (acc. to IEC 61010-1): II

See also electrical data (chap. 26.3).

	<p>To completely separate the chamber from the power supply, you must disconnect the power plug. Install the chamber in a way that the power plug is easily accessible and can be easily pulled in case of danger.</p>
---	--

## 5. Functional overview of the chamber controller

The chamber controller controls the temperature inside the chamber:

You can enter the desired set point value in the “**Set points**” menu directly at the controller.

The controller offers various notifications and alarm messages with visual and audible indication. All controller settings remain valid until the next manual change. They are stored also after turning off the chamber.

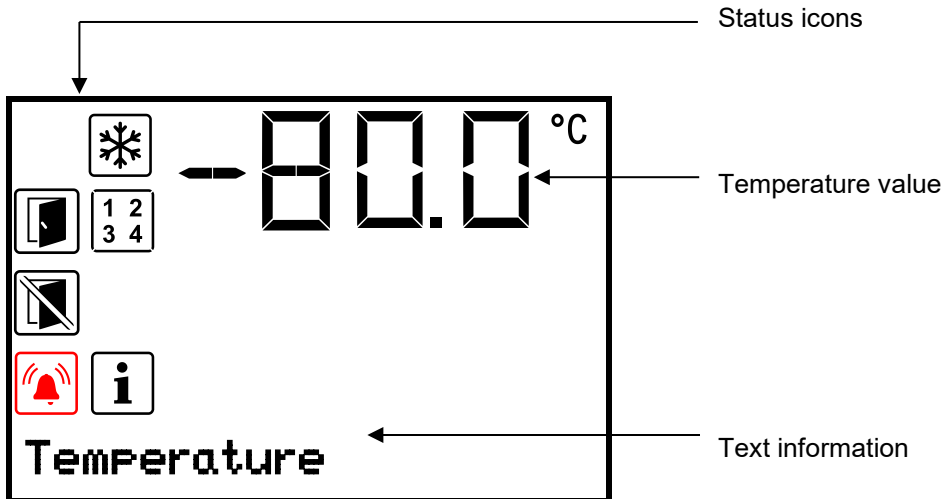

Figure 17: Normal display of the chamber controller (sample values)

### Status icons in the controller display

Icon	Signification	Icon	Signification
	Door open		Refrigeration active
	Do not open the door		Display of activated special controller functions. 1 = CO <sub>2</sub> emergency cooling activated 2 = Emergency cooling test activated 3 = Service setpoint active
	Information		
	Collective alarm		

### Functional controller keys

Icon	Signification	Function
	<b>Arrow-up button</b>	<ul style="list-style-type: none"> <li>Navigate between menus, submenus, other functions</li> <li>In the setting menu: change setting, increase value</li> </ul>
	<b>Arrow-down button</b>	<ul style="list-style-type: none"> <li>Navigate between menus, submenus, other functions</li> <li>In the setting menu: change setting, decrease value</li> </ul>
	<b>OK button</b>	<ul style="list-style-type: none"> <li>Select menu, submenu, function</li> <li>In the setting menu: Confirm entry</li> </ul>
	<b>Back button</b>	Back to previous menu level
	<b>Standby button</b>	no function

## 5.1 Menu structure of the controller and access levels

Starting from **Normal display**, navigate between the menus with the **arrow buttons**.

With the **OK button** you enter the setting of further subordinate menu functions.

With the **Back button** you go back to the previous function and finally back to Normal display.

The available functions depend on the current dependent on the current **authorization** "User", "Admin" or "Service", for which the entry of a password may be required, depending on the setting.

You can set passwords for different access levels:

- **User:** The password enables access to the standard operating functions. Factory setting is 00 00 (no password assigned).
- **Admin:** The password enables access to advanced controller functions and settings. Factory setting is 00 01.
- **Service:** The password enables access to all controller functions (for Service only).

As soon as a password has been assigned, access to the respective functions is blocked and only available after entering the correct password.

Menu	Required access level	Functions
<b>Setpoints</b>	"User"	<ul style="list-style-type: none"> <li>• Temperature set-point setting</li> <li>• CO<sub>2</sub> emergency cooling set-point setting (option)</li> <li>• Setting the safety controller</li> <li>• Activating/deactivating the CO<sub>2</sub> emergency cooling (option) and the service setpoint, emergency cooling test (option)</li> </ul>
<b>Chamber info</b>	Any user	<ul style="list-style-type: none"> <li>• Configuration display (setup information, controller hardware and software, analog inputs)</li> <li>• Display of battery condition (battery-buffered alarm system)</li> <li>• Display of interface configuration (e.g. MAC address, IP address)</li> </ul>
<b>Settings</b>	"Admin"	<ul style="list-style-type: none"> <li>• General controller settings (date, time, menu language, temperature unit, display brightness...)</li> <li>• Network settings</li> <li>• Setting the data logger storage interval</li> <li>• Setting the alarm limit for range alarm and delay times for door open and range alarm, setting the service setpoint</li> <li>• Password changing for User and Admin</li> </ul>
<b>Service</b>	"Service"	<ul style="list-style-type: none"> <li>• Configuration settings (only for Service)</li> <li>• Password changing for User and Admin</li> </ul>
<b>USB</b> (visible when inserting a USB stick)	Export: Any user Import: "Admin"	<ul style="list-style-type: none"> <li>• Export of configuration, logger, and service data</li> <li>• Import of configuration data</li> </ul>

Unless noted otherwise, the figure in this manual show the functional range, which is available for the user with "Admin" authorization level

Note: When specifying the path to the respective function, the possibly required entry of a password is not listed.

## 6. Start up



Following transport, wait at least 8 hours until start-up.

Check that the interior of the freezer is empty. Prior to starting a new freezer or if you do not know what the freezer was last used for, for hygiene purposes you should clean and disinfect the interior (chap. 23).

After connecting the supply lines, turn on the chamber by the main power switch (4) (position 1). The lit pilot lamp shows the chamber is ready for operation.

The controller shows normal display and controls the temperature to the last entered values.

### 6.1 Preset factory parameters

The chamber is supplied with the following preset parameters, which can be changed in the corresponding menus:

Temperature set point	-80 °C / -112 °F
Safety controller	Set point type "Limit" -65 °C / -85 °F
The maximum permitted deviation from the temperature set point as alarm limit for range alarm	+/- 5 K
Alarm delay time after opening the door	1 minute
Alarm delay time after leaving the alarm limit for range alarm (Following opening the door or chamber startup, the range alarm becomes valid only after the setpoint has been reached)	60 minutes
Password for "User" authorization	0 (no locking)
Password for "Admin" authorization	1

### 6.2 Behavior after turning on the chamber

During the equilibration phase of approx. 8 hours after turning on the chamber, undefined temperature conditions occur within the chamber. During this phase, do not place any sample materials in the chamber



#### NOTICE

**Danger of temperature fluctuation.  
Destruction of samples.**

- Load the freezer only after equilibration of temperature.



#### NOTICE

**Malfunction of the door control depending on the time of day.  
Longer time until the door reopens.**

- Set the correct date and time on the controller.



If the function "Language selection at restart" has been activated (chap. 12.5, factory setting ON), the following settings are checked upon start up:

- **Menu language** (chap. 12.1):  
Use the **arrow buttons** to select the desired language, confirm with the **OK button**
- **Temperature unit** (chap. 12.2):  
Use the **arrow buttons** to select the desired temperature unit, confirm with the **OK button**.
- **Current date** (chap. 12.3), format DD MM YYYY:  
Use the **arrow buttons** to set the day, continue with the **OK button**.  
Use the **arrow buttons** to set the month, continue with the **OK button**.  
Use the **arrow buttons** to set the year, confirm with the **OK button**
- **Current time** (chap. 12.4), format HH:MM:  
Use the **arrow buttons** to set the hours, continue with the **OK button**.  
Use the **arrow buttons** to set the minutes, confirm with the **OK button**

Set the controller to the desired temperature set point (chap. 7) used to operate the freezer.



As long as there is a difference between the actual and set value shown in the display, the intended operation of the chamber will not be ensured.

## 7. Temperature set-point entry

Required access level: "User".

**Setting and control range:** -40 °C / -40 °F up to -90 °C / -130 °F

To set a lower setpoint value for test purposes or for adjustment, you can enter and activate a service setpoint (chap. 19). This setting is outside the control range and is not intended for normal operation.

Path: **Normal display**  **Setpoints**  **Temperature**

Press the **OK button** to enable the setting.

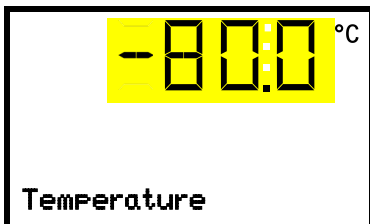

Temperature setting.

The current setting flashes. Enter the desired set-point with the **arrow buttons**.

Confirm the entry with the **OK button**.

With the **Back button** you can go back to the "Setpoints" submenu and, repeatedly pressing it, to **Normal display**.



With safety controller mode "Limit", adapt the safety controller always when you changed the temperature set-point. Set the safety controller value by approx. 15 °C above the temperature set-point (chap. 11).

Recommended setting: safety controller mode "Offset" with safety controller value 15 °C.

Only insert samples into the freezer when it has reached its stable operating state.

Temperature equilibrating time to -80 °C / -112 °F is approx. 3 hours (SUFsg 3501) / approx. 6 hours (SUFsg 5001) / approx. 7.5 hours (SUFsg 7001).

## 7.1 Setting the Manual Offset value

A spatial temperature measurement shows that the range in which all temperature values are located is not symmetrical to the setpoint: The mean value of this temperature range deviates from the current setpoint in a positive or negative direction.

If desired, the deviation of the mean value of the spatial temperature range from the setpoint can be compensated for by setting a Manual Offset value.

This manual offset value is added to the setpoint or subtracted from it and results in a new working setpoint for the control. The original setpoint remains visible in the controller display.

### Example of calculation:

Setpoint: -80 °C

The limits of all temperature sensors in a spatial temperature measurement are in a range between -81 °C and -77 °C; the middle of this range is -79 °C

The deviation of this mean value from the entered setpoint is therefore +1 K.

The setting value for the manual offset would then be: -1 K

### Setting:

Required access level: "Admin".

Path: **Normal display** ▾ ▾ ▾ **Settings**  ▾ ▾ ▾ **Various**  ▾ ▾ ▾ ▾ **Manual Offset**

Press the **OK button** to enable the setting.



#### Setting the Manual Offset

The current setting flashes. Use the **arrow buttons** to enter the desired value. Entry range: -6 K up to 6 K, Factory setting: 0 K.

Confirm the setting with the **OK button**.

With the **arrow-up button** you can go to setting the alarm limit for Service setpoint (chap. 19.1).

With the **Back button** you can go back to the "**Various**" submenu and, repeatedly pressing it, to **Normal display**.

## 8. Placing samples in storage in the freezer

Before storing valuable samples, conduct a 10-days test run at the desired temperature. This helps to detect transport damages like capillary cracks. Then you can load the freezer with the precooled samples.

	<p><b>WARNING:</b> If customer should use a freezer running in non-supervised continuous operation, we strongly recommend in case of inclusion of irrecoverable specimen or samples to split such specimen or samples and store them in at least two chambers, if this is feasible.</p>
---	---



During the equilibration phase of approx. 8 hours after turning on the chamber, undefined temperature conditions occur within the chamber. During this phase, do not place any sample materials in the chamber

	<b>NOTICE</b>
<p><b>Danger of temperature fluctuation.</b>  <b>Destruction of samples.</b></p> <ul style="list-style-type: none"> <li>➤ Load the freezer only after equilibration of temperature.</li> </ul>	

When placing not precooled samples in storage, temperature rises inside the freezer. We recommend to successively load the freezer. The more thermal energy you bring in, the longer it takes until reaching the set-point temperature again.

Do not exceed the maximum load of each compartment and the permitted total load (see chap.26.3).

The inner surfaces become very cold during operation. Always wear protective gloves when opening the freezer and bringing in or removing material.

	 <b>CAUTION</b>
<p><b>Danger of injury by freezing on when touching cold chamber parts during operation.</b>  <b>Local frostbite.</b></p> <ul style="list-style-type: none"> <li>⊘ Do NOT directly touch the inner surfaces or the charging material during operation.</li> <li>⊘ AVOID skin contact with the inner surfaces and accessory equipment.</li> <li>➤ Wear protective gloves when opening the inner doors and during manipulation.</li> </ul>	

After the outer door has been closed, it can only be opened again after a waiting time. This time depends dynamically on the length of time since the door was last opened:

- More than 7 days since the door was last opened: 90 seconds waiting time
- Less than 7 days but more than 24 hours since the door was last opened: 70 seconds waiting time
- Less than 24 hours since the door was last opened: 30 seconds waiting time

The waiting time is displayed on the controller in Normal display as a countdown. In addition, the information icon is lit, and the icon "Do not open the door" flashes.

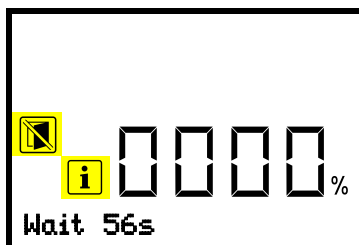

Normal display during the waiting time after the outer door has been closed (example)

Note: If the door has not been opened for a longer period of time (more than 5 days), it is advisable to de-ice the door gaskets and the inner opening of the pressure compensation valve (I) (see chap. 24.2.3). After that, the door can be opened even after a short period of time without applying great force.

## 9. Setting special controller functions

In the “Functions on/off” menu you can define the switching state of up to 4 controller functions.

Required access level: “User”.

Path: **Normal display**  **Setpoints**   **Functions on/off**

With optional CO<sub>2</sub> emergency cooling:

Path: **Normal display**  **Setpoints**    **Functions on/off**

The functions are displayed from left to right.

**Example:** Function 1 activated = 1000. Function 1 deactivated = 0000.

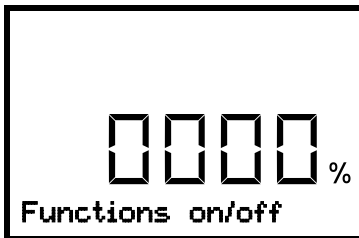

Submenu “**Functions on/off**”.

This view shows the switching states of the four available functions.

“1” = Function activated

“0” = Function deactivated

Press the **OK button** to access the first individual function. With the **arrow-down button** you can proceed to the subsequent functions.

The functions 1 and 2 are only available with the chamber with optional CO<sub>2</sub> emergency cooling.

- Function 1 “CO<sub>2</sub> emer.cooling on/off”: Activating the CO<sub>2</sub> emergency cooling, chap. 20.3.2
- Function 2 “CO<sub>2</sub> cooling test on/off”: Test run of the CO<sub>2</sub> emergency cooling, chap. 20.3.3
- Function 3 “Service setpoint on/off”: Activating the service setpoint, chap. 19.2
- Function 4 has no function with this chamber type.

Press the **OK button** to enable the setting of the desired function and select the function’s switching state “1” (function activated) or “0” (function deactivated).

With the **Back button** you can go back to the “**Setpoints**” submenu and, repeatedly pressing it, to **Normal display**.

In Normal display the activated functions are indicated by an icon showing the number of the respective function.

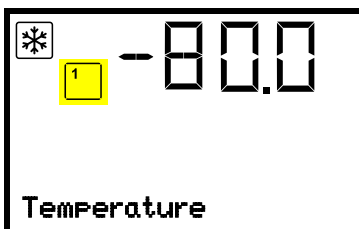

Example:

Normal display with activated function 1 “CO<sub>2</sub> emer.cooling on/off”



The settings for the CO<sub>2</sub> emergency cooling (option) are described in chap. 20.

## 10. Password

### 10.1 Password request

To access menus for which access is restricted, you must enter the corresponding password.

After calling the appropriate menu function with the **OK button** the password request appears.

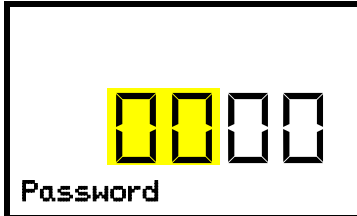

Password request.

The left two digits are flashing. Enter the desired numbers with the **arrow buttons**.

Confirm the setting with the **OK button**.

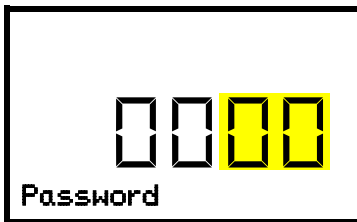

Password request.

The right two digits are flashing. Enter the desired numbers with the **arrow buttons**.

Confirm the setting with the **OK button**.

Upon entering an incorrect password, the message "Wrong password" is displayed.

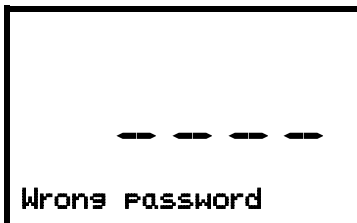

Display "Wrong password".

After 3 seconds the controller changes again to the password entry.

Enter the correct password.

Following correct password entry, you can access the desired menu function.

### 10.2 Assign and modify a password

In this menu you can assign and modify the passwords of the "User" and "Admin" access levels.

Required access level: "Admin".

## 10.2.1 Assign and modify the User password

Path: **Normal display** ▾ ▾ ▾ **Settings**  **Chamber** ▾ ▾ ▾ ▾ **Password User**

Press the **OK button** to enable the setting.

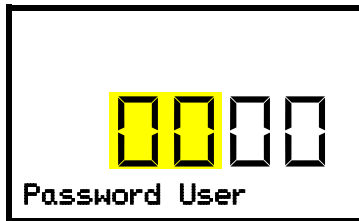

Setting the User password.  
The left two digits are flashing. Enter the desired numbers with the **arrow buttons**.  
Confirm the setting with the **OK button**.

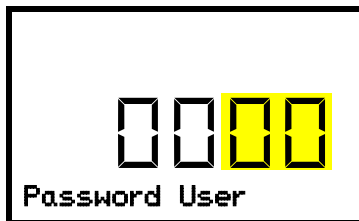

Setting the User password.  
The right two digits are flashing. Enter the desired numbers with the **arrow buttons**.  
Confirm the setting with the **OK button**.

With the **arrow-down button** you can now proceed to enter the Admin password.

With the **Back button** you can go back to the "**Chamber**" submenu and, repeatedly pressing it, to **Normal display**.



Keep the password well in mind. There is no access to the corresponding menu functions without the correct password.

## 10.2.2 Assign and modify the Admin password

Path: **Normal display** ▾ ▾ ▾ **Settings**  **Chamber** ▾ ▾ ▾ ▾ **Password Admin**

Press the **OK button** to enable the setting.

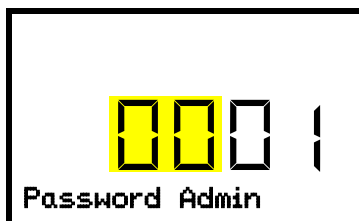

Setting the Admin password.  
The left two digits are flashing. Enter the desired numbers with the **arrow buttons**.  
Confirm the setting with the **OK button**.

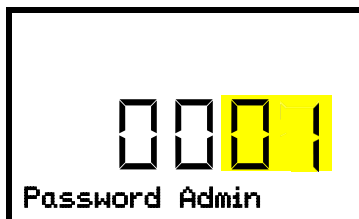

Setting the Admin password.  
The right two digits are flashing. Enter the desired numbers with the **arrow buttons**.  
Confirm the setting with the **OK button**.

With the **Back button** you can go back to the "**Chamber**" submenu and, repeatedly pressing it, to **Normal display**.



Keep the password well in mind. There is no access to the corresponding menu functions without the correct password.

## 10.3 Performance during and after power failure and shut down

During a power supply failure, the battery maintains the controller functions. The controller display is dark and can be activated for 5 seconds by pressing any button. The refrigerating machine is out of operation. The chamber's refrigerating function can be maintained through the CO<sub>2</sub> emergency cooling (option, chap. 19). The zero-voltage relay alarm output (9) (chap. 14.4.7) is switched for the whole duration of the power failure.

After the power returns or when turned on by hand, all functions return to the same status the chamber had before power failure. The freezer regulates the temperature to the last entered set point.



All settings and set point values remain in the memory during power failure after power off.

If an alarm has occurred caused by the power supply failure (e.g., range alarm, safety controller etc.), confirm the alarm. See chap. 14.

## 11. Safety controller (temperature safety device)

The SUFsg freezer is equipped with an electronic over temperature safety device. It is designated as the "safety controller". This second, electrically independent temperature controller emits an alarm at a selectable set point in case of fault. Thus it serves to protect the charging material against excessively high temperatures. This condition (state of alarm) is indicated visually and additionally with an audible alert if the buzzer is enabled (chap. 14.3). The alarm persists until the chamber cools down below the configured safety controller value and the alarm is reset on the controller. The safety controller is independent of the temperature control system.

Please observe the regulations applicable to your country.



Regularly check the safety controller setting. Set the safety controller set point by approx. 15 °C above the desired temperature set point.



The safety controller only activates after the set-point has been reached. This condition must be met every time the door was opened.



The settings of the safety controller are inactive during battery operation, open door, power failure, CO<sub>2</sub> emergency cooling (option). They become functional again following restitution of power supply and/or the restart of the chamber with the main power switch (4).

You can set the **safety controller mode** to "Limit" or "Offset".

- **Limit:** Limit value, absolute maximum permitted temperature value

This setting offers high safety as a defined temperature limit will not be exceeded. It is important to adapt the safety controller value after each modification of the temperature set-point. Otherwise, the limit could be too high to ensure efficient protection, or, in the opposite case, it could prevent the controller from reaching an entered set-point outside the limit range.

- **Offset:** Offset value, maximum overtemperature above any active temperature set point. The resulting maximum temperature changes internally and automatically with every temperature set-point change.

## Example:

Desired temperature value: -80 °C, desired safety controller value: -65 °C.

Possible settings for this example:

Temperature set point	Safety controller mode	Safety controller value
-80 °C	Limit	Limit value -65 °C
	Offset	Offset value 15 °C

## 11.1 Setting the safety controller mode

Required access level: "User".

Path: **Normal display**  **Setpoints**    **Safety controller**  **Mode**

With optional CO<sub>2</sub> emergency cooling:

Path: **Normal display**  **Setpoints**    **Safety controller**  **Mode**

Press the **OK button** to enable the setting.

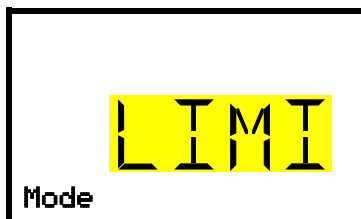

Setting the safety controller mode

The current setting flashes. Use the **arrow buttons** to select between LIMI (Limit) and OFFS (Offset).

Confirm the setting with the **OK button**.

With the **arrow-down button** you proceed to setting the safety controller value (chap. 11.2)

With the **Back button** you can go back to the "**Safety controller**" submenu and, repeatedly pressing it, to **Normal display**.

## 11.2 Setting the safety controller value

Required access level: "User".

The desired safety controller mode must be selected first (chap. 11.1). Depending on the mode setting, one of the following setting menus will appear.

Path: **Normal display**  **Setpoints**    **Safety controller**   **Limit or Offset**

With optional CO<sub>2</sub> emergency cooling:

Path **Normal display**  **Setpoints**    **Safety controller**   **Limit or Offset**

Press the **OK button** to enable the setting.

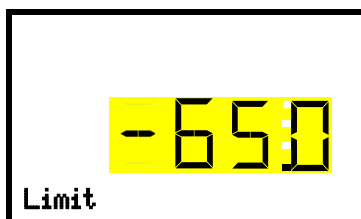

Setting the safety controller value with "Limit" safety controller mode.

The current value flashes. Enter the desired limit value with the **arrow buttons**. Setting range: -20 °C to -110 °C.

Confirm the entry with the **OK button**.



Or

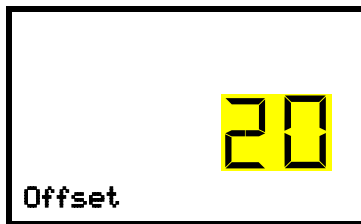

Setting the safety controller value with “Offset” safety controller mode  
The current value flashes. Enter the desired offset value with the **arrow buttons**.  
Confirm the entry with the **OK button**.

With the **Back button** you can go back to the “**Safety controller**” submenu and, repeatedly pressing it, to **Normal display**.



Regularly check the settings of the safety controller mode and value.  
Set the safety controller value by approx. 15 °C above the desired temperature set-point.

## 11.3 Message and measures in the state of alarm

The state of alarm is indicated visually in Normal display. If the buzzer is enabled (chap. 14.3) there is an additional audible alert. A text message indicates the alarm cause. The “collective alarm” icon is lit. If the audible arm is activated, the buzzer sounds. Press the **OK button** to mute the buzzer.

The alarm message “Safety controller” and the “Collective alarm” icon are displayed on the controller until you press the **OK button** on the controller **and** the inner chamber temperature has cooled down below the safety controller value.

- If the inner chamber temperature has already cooled down below the safety controller value when pressing the **OK button**, the alarm message “Safety controller” and the “Collective alarm” icon are reset together with the buzzer.
- If the state of alarm is still active when pressing the **OK button**, i.e. the inner chamber temperature is still above the safety controller value, first only the buzzer is reset. The alarm message “Safety controller” and the “Collective alarm” icon will disappear as soon as the inner chamber temperature falls below the safety controller value.

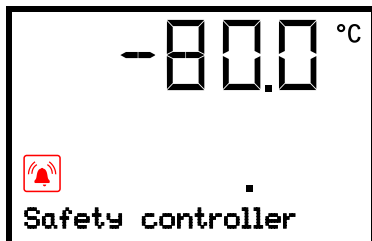

Normal display showing safety controller alarm (sample value)

### Note:

When the safety controller had been activated you should transfer the samples into another freezer and then disconnect the chamber from the power supply and have an expert examine and rectify the cause of the fault.

## 11.4 Function check

Check the safety controller at appropriate intervals for its functionality. It is recommended that the authorized operating personnel should perform such a check, e.g., before starting a longer work procedure.

## 12. General controller settings

The general settings can be accessed in the “**Settings**” submenu, which is available for users with “Service” or “Admin” authorization level. It serves to enter date and time, select the language for the controller menus and the desired temperature unit and to configure the controller’s communication functions.

The display of some network settings is available for all users in the “**Chamber info**” menu.

### 12.1 Selecting the controller’s menu language

The chamber controller communicates by a menu guide using real words in German, English, French, Spanish, and Italian languages.

Required access level: “Admin”. Following start-up of the chamber (chap. 6), it is “User”.

Path: **Normal display**    **Settings**  **Chamber**    **Language\***

\* Following start-up of the chamber: **Sprache / Language / Langue / Idioma / Lingua**, depending on the language selected before turning off the chamber

Press the **OK button** to enable the setting.

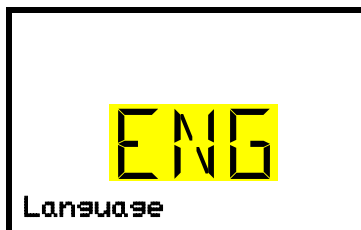

Setting the menu language (example: English).  
The current setting flashes. Use the **arrow buttons** to select the desired language.  
Confirm the entry with the **OK button**.

With the **arrow-down button (twice)** you can now change to the temperature unit setting.

With the **Back button** you can go back to the “**Chamber**” submenu and, repeatedly pressing it, to **Normal display**.

### 12.2 Selecting the temperature unit

Required access level: “Admin”. Following start-up of the chamber (chap. 6), it is “User”.

Path: **Normal display**    **Settings**  **Chamber**     **Temperature unit**

Press the **OK button** to enable the setting.

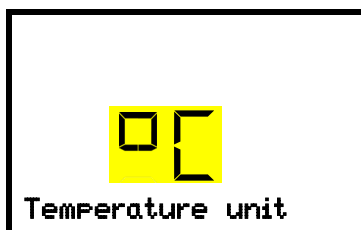

Setting the temperature unit  
The current setting flashes. Use the **arrow buttons** to select between °C (degrees Celsius) and °F (degrees Fahrenheit).  
Confirm the entry with the **OK button**.

You can change the temperature unit between °C and °F.

If the unit is changed, all values are converted accordingly

	C = degree Celsius	0 °C = 31 °F	Conversion: [value in °F] = [value in °C] * 1,8 + 32
	F = degree Fahrenheit	100 °C = 212 °F	

With the **Back button** you can go back to the “**Chamber**” submenu and, repeatedly pressing it, to **Normal display**.

## 12.3 Setting the current date

Required access level: "Admin". Following start-up of the chamber (chap. 6), it is "User".

Path: **Normal display**    **Settings**  **Chamber**  **Date**

Press the **OK button** to enable the setting.

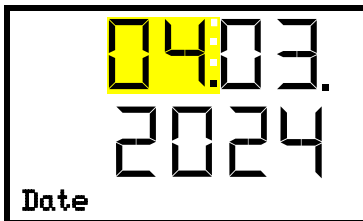

Setting the date: day  
The current setting flashes. Enter the current day with the **arrow buttons**.  
Confirm the entry with the **OK button**.



Setting the date: month  
The current setting flashes. Enter the current month with the **arrow buttons**.  
Confirm the entry with the **OK button**.



Setting the date: year  
The left two digits are flashing. Enter the first two digits of the current year with the **arrow buttons**.  
Confirm the entry with the **OK button**.



Setting the date: year  
The right two digits are flashing. Enter the last two digits of the current year with the **arrow buttons**.  
Confirm the entry with the **OK button**.

With the **arrow-down button** you can now change to setting the current time.

With the **Back button** you can go back to the "Chamber" submenu and, repeatedly pressing it, to **Normal display**.



Check the date when you use the chamber for the first time or when you change local summer time and adjust it if necessary.



### NOTICE

**Malfunction of the door control depending on the time of day.**

**Longer time until the door reopens.**

➤ Set the correct date on the controller.

## 12.4 Setting the current time

Required access level: "Admin". Following start-up of the chamber (chap. 6), it is "User".

Path: **Normal display**    **Settings**  **Chamber**   **Time**

Press the **OK button** to enable the setting.

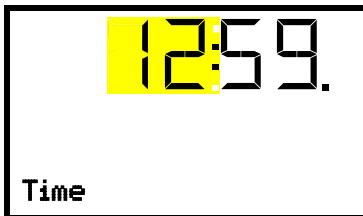

Setting the time: hours  
The current setting flashes. Enter the current hour with the **arrow buttons**.  
Confirm the entry with the **OK button**.

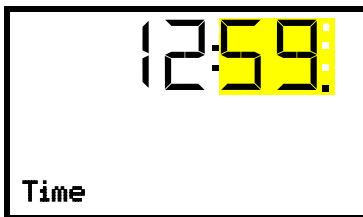

Setting the time: minutes  
The current setting flashes. Enter the current minutes with the **arrow buttons**.  
Confirm the entry with the **OK button**.

With the **Back button** you can go back to the "Chamber" submenu and, repeatedly pressing it, to **Normal display**.

	NOTICE
	<p><b>Malfunction of the door control depending on the time of day.</b>  <b>Longer time until the door reopens.</b>          ➤ Set the correct time on the controller.</p>

## 12.5 Function "Language selection at restart"

If the function "Language selection at restart" is activated, menu language, date, time, and temperature unit are checked with every startup of the chamber. At this occasion it is also possible to modify them with "User" access level.

Required access level: "Admin".

Path: **Normal display**    **Settings**  **Chamber**     **Language selection at restart**

Press the **OK button** to enable the setting.



Function "Language selection at restart"  
The current setting flashes. Use the **arrow buttons** to select between ON and OFF.  
Confirm the setting with the **OK button**.

With the **arrow-down button** you can now change to the next parameter (chamber address).

With the **Back button** you can go back to the "Chamber" submenu and, repeatedly pressing it, to **Normal display**.

## 12.6 Setting the chamber address

This setting is required for computer communication. The chamber address settings in the chamber controller and in any software must be identical.

Required access level: "Admin".

Path: **Normal display** ▾ ▾ ▾ **Settings**  **Chamber**  ▾ ▾ ▾ ▾ ▾ **Chamber address**

Press the **OK button** to enable the setting.



Setting the chamber address

The current setting flashes. Enter the desired address with the **arrow buttons**. Setting range: 1 up to 254

Confirm the entry with the **OK button**.

With the **arrow-down button** you can now change to the next parameter (display brightness).

With the **Back button** you can go back to the "**Chamber**" submenu and, repeatedly pressing it, to **Normal display**.

## 12.7 Display brightness

Required access level: "Admin".

Path: **Normal display** ▾ ▾ ▾ **Settings**  **Chamber**  ▾ ▾ ▾ ▾ ▾ ▾ **Brightness**

Press the **OK button** to enable the setting.



Setting the display brightness

The current setting flashes. Enter the desired value with the **arrow buttons**. Setting range: 10% up to 100%

Confirm the entry with the **OK button**.

With the **arrow-down button** you can now change to the next parameter (audible alarm, chap. 14.3).

With the **Back button** you can go back to the "**Chamber**" submenu and, repeatedly pressing it, to **Normal display**.

## 13. Setting the alarm limit for range alarm and the alarm delays

In this menu you can define the deviation between the actual value and setpoint of, which that shall cause a range alarm. The entered value defines the limit of permitted deviations from the set-point (exceeding and falling below). Reaching this limit triggers a range alarm.

In addition, you can specify a delay time for the range alarm and the door open alarm.

During the delay time there is no alarm message after leaving the alarm limit of the range alarm:

- After turning on the chamber or returning power supply or after a door opening in case the set-point hasn't been reached: fixed delay time of 15 hours
- After leaving the alarm limit of the range alarm in normal operation: adjustable delay time (chap. 13.2)

If the actual value is outside the alarm limit of the range alarm, after the configured alarm delay time the alarm message "Temperature range" is displayed in Normal display (chap. 14.1). If the alarm buzzer is activated (chap. 14.3) there is an audible alert.

This function only activates after the set-point has been reached. This condition must be met every time the door was opened.

Required access level: "Admin".

### 13.1 Setting the delay time for door open alarm

Path: **Normal display** ▾ ▾ ▾ **Settings**  ▾ ▾ ▾ **Various**  **Door alarm delay (min)**

Press the **OK button** to enable the setting.

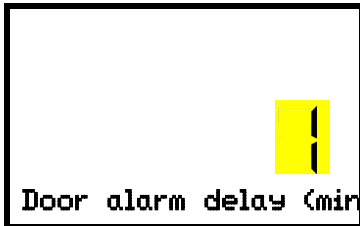

Setting the door alarm delay.

The current setting flashes. Use the **arrow buttons** to enter the desired time after which the door open alarm shall be triggered. Entry range: 1 up to 600 minutes. Factory setting: 1 minute.

Confirm the entry with the **OK button**.

With the **arrow-down button** you can now change to the range alarm delay setting.

With the **Back button** you can go back to the "Various" submenu and, repeatedly pressing it, to **Normal display**.

### 13.2 Setting the delay time for range alarm

Following opening the door or chamber startup, the range alarm becomes valid only after the setpoint has been reached.

Path: **Normal display** ▾ ▾ ▾ **Settings**  ▾ ▾ ▾ **Various**  ▾ **Range alarm delay (min)**

Press the **OK button** to enable the setting.

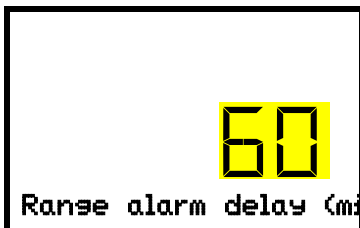

Setting the range alarm delay.

The current setting flashes. Use the **arrow buttons** to enter the desired time after which the range alarm shall be triggered. Entry range: 1 up to 300 minutes. Factory setting: 60 minutes.

Confirm the entry with the **OK button**.

With the **arrow-up button** you can go back to the door alarm delay setting.

With the **arrow-down button** you can now change to setting the alarm limit of the range alarm.

With the **Back button** you can go back to the “**Various**” submenu and, repeatedly pressing it, to **Normal display**.

### 13.3 Setting the alarm limit of the range alarm

A temperature range (alarm limit) is defined symmetrically around the setpoint. If the actual temperature value lies within this alarm limit and subsequently leaves it, range alarm is triggered after the set adjustable delay time (chap. 13.2)

Path: **Normal display** ▾ ▾ ▾ **Settings** OK ▾ ▾ ▾ **Various** OK ▾ ▾ **Temperature range**

Press the **OK button** to enable the setting.

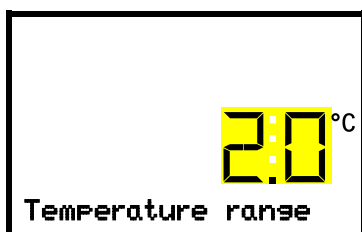

Setting the temperature tolerance range (alarm limit)  
The current setting flashes. Enter the desired temperature range with the **arrow buttons**. Entry range: 1,0 °C up to 10,0 °C. Factory setting: +/- 5 K  
Confirm the entry with the **OK button**.

With the **arrow-up button** you can go back to the range alarm delay setting.

With the **arrow-down button** you can now change to the service setpoint setting (chap. 19.1).

With the **Back button** you can go back to the “**Various**” submenu and, repeatedly pressing it, to **Normal display**.

## 14. Alarm functions

### 14.1 Alarm messages



**WARNING:** If customer should use a chamber running in non-supervised continuous operation, we strongly recommend in case of inclusion of irrecoverable specimen or samples to split such specimen or samples and store them in at least two chambers, if this is feasible.

In the event of equipment failures, when the temperature deviates from the alarm limit of the range alarm, optical and possibly acoustic alarm messages are given out via the controller. A zero-voltage relay alarm output (9) (chap. 14.4.7) permits transmission of the alarm e.g., to a central monitoring system.

The alarm messages door open and leaving the alarm limit of the range alarm are emitted after a configurable delay (chap. 13), the others immediately when the fault occurs. The range alarm is suppressed after opening the chamber door or turning on the freezer until the setpoint is reached and then for the selected delay time.



In Normal display a text message indicates the alarm cause. The “collective alarm” icon flashes. If the audible arm is activated, the buzzer sounds.

If more than one alarm signal is sent simultaneously, they are displayed in a cycle.

Press the **OK button** to confirm the alarm and mute the buzzer. If the alarm cause is still valid, the “collective alarm” icon is lit.



Alarm indication (example: safety controller alarm)

#### Alarm messages overview:

Condition	Alarm message	Moment of Alarm message and switching the zero-voltage relay alarm output
Chamber door open	“Door open”	after configurable time (chap. 13). Factory setting: 1 minute
Exceeded setpoint of the safety controller	“Safety controller”	immediately
The current actual temperature value is outside the alarm limit of the range alarm (chap. 13)	“Temp. range”	after configurable time (chap. 13). Factory setting: 60 minutes
Continuous compressor operation, refrigeration system defective. Contact Service.	“Continuous operation”	<ul style="list-style-type: none"> <li>• 15 hours after start-up or a door opening, if the set-point wasn't reached</li> <li>• 60 minutes after reaching the set-point</li> </ul>
Clean / replace the condenser air filter (chap. 24.2.1)	“Condenser temp.”	after 10 hours
Compressor defective. Contact Service.	“Compressor defective”	immediately
Inner temperature sensor defective. Control continues using the safety controller temperature sensor	“Inner temp. sensor”	immediately



Condition	Alarm message	Moment of Alarm message and switching the zero-voltage relay alarm output
Safety controller temperature sensor defective	"Safety control sensor"	immediately
Inner temperature sensor and safety controller temperature sensor defective. Refrigeration is turned on permanently.	Temperature display shows " - - - " or "<-<-<" or ">->->" Messages alternating: "Inner temp. sensor" and "Safety control sensor"	immediately
Failure of Pt100 temperature sensor on the condenser of the refrigerating machine.	"Condensate temp. sensor"	immediately
Failure of Pt100 temperature sensor on the cascade of the refrigerating machine. Refrigeration is turned on permanently.	"Cascade temp. sensor"	immediately
Failure of Pt100 temperature sensor for ambient temperature or air intake of the 1 <sup>st</sup> stage cooling (refrigerating machine).	"Ambient temp. sensor"	immediately
Battery operation (during power failure)	"Battery operation"	immediately
No battery recognized. Cause: Battery missing or defective. Message on line power.	"Battery defective"	immediately
<i>Chamber with optional CO<sub>2</sub> emergency cooling:</i> activated CO <sub>2</sub> emergency cooling automatically turned on due to power failure and is running.	"CO <sub>2</sub> emergency cooling"	immediately
<i>Chamber with optional CO<sub>2</sub> emergency cooling:</i> Insufficient CO <sub>2</sub> supply of the activated CO <sub>2</sub> emergency cooling system	"CO <sub>2</sub> pressure"	immediately
Power failure (chamber without battery or with message "Battery defective")	--	immediately (alarm output only)

Press the **OK button** to confirm the alarm.

- Confirmation while the state of alarm persists: Only the buzzer is muted. The visual alarm message continues to be displayed until the alarm condition is removed. Then it is reset automatically.
- Confirmation after the alarm has ended: The buzzer and the visual alarm message are reset together.

## 14.2 Information messages

Information messages provide information about settings made and the condition of the battery.

 In Normal display a text message indicates the condition. The “Information” icon is lit.

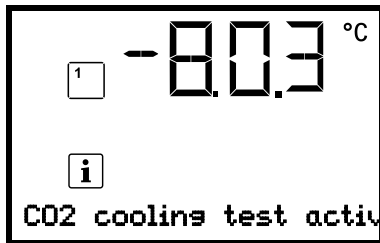

Information message (example: CO<sub>2</sub> emergency cooling test run is active)

Information messages overview:

Condition	Information message	Moment of information message
Very low battery voltage (1 V to 11 V). Low battery voltage on battery power. Message on battery power and line power.	“Low battery voltage”	immediately
Service setpoint is active	“Service setpoint active”	immediately
Emergency cooling test run is active	“CO <sub>2</sub> cooling test active”	immediately

## 14.3 Activating / deactivating the audible alarm (alarm buzzer)

Path: **Normal display**    **Settings**  **Chamber**         **Audible alarm**

Press the **OK button** to enable the setting.

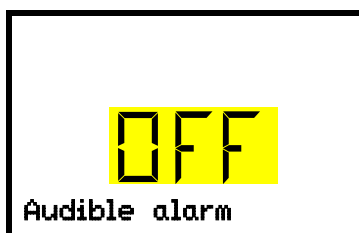

Setting the audible alarm.

The current setting flashes. Use the **arrow buttons** to select between ON and OFF.

Confirm the setting with the **OK button**.

With the **Back button** you can go back to the “**Chamber**” submenu and, repeatedly pressing it, to **Normal display**.

## 14.4 Required actions in case of an alarm



Only qualified service personnel authorized by the manufacturer must perform repair. Repaired chambers must comply with the manufacturer's quality standards.

### 14.4.1 Safety controller temperature alarm

The selected temperature value of the safety controller was exceeded.

The alarm occurs immediately.

- Alarm message "Safety controller", "collective alarm" icon
- Audible alarm (buzzer)
- Switching the zero-voltage relay alarm output

#### Actions:

- Check whether the outer door was open for a long time or is not closed properly. Close the door if necessary. With open door there can be additional door open alarm.
- Check the setting of the safety controller (chap. 11). The limit temperature should be approx. by 15 K above the temperature set point. If necessary, adjust the relevant value.
- Check whether samples were inserted into the freezer that may release heat.
- Check the ambient conditions. Protect the freezer from direct sunlight. Ensure sufficient ventilation around the installation location to prevent any buildup of heat in the chamber.
- If these points do not reveal the source of the fault, it may be that the chamber is faulty. Please contact the Service.

### 14.4.2 Temperature range alarm (too high and too low temperature)

The temperature range alarm becomes valid only after the setpoint has been reached.

When the actual temperature value leaves the alarm limit of the range alarm, the alarm occurs after the defined delay time (chap. 13). Factory setting: 60 minutes.

- Alarm message "Temp. range", "collective alarm" icon
- Audible alarm (buzzer)
- Switching the zero-voltage relay alarm output

#### Actions:

- Factory setting is +/- 5 K.
- Use the actual temperature displayed on the controller to verify whether the alarm limit of the range alarm has been breached, i.e., too cold or too warm.

#### Temperature too low (under temperature alarm):

- Input of large quantities of samples which were precooled with liquid nitrogen. Reset the alarm with the **OK button**.
- Possible cause: Continuous operation of the refrigeration machine after failure of one or several temperature sensors (chap. 14.4.6). In addition, there is continuous operation alarm. Contact the Service.

## Temperature too high (over temperature alarm):

- Check whether the outer door was open for a long time or is not closed properly. Close the door if necessary. In addition, there is door open alarm.
- Check the door gaskets for damage. Replace any damaged gaskets.
- Check whether there is icing around the gaskets. Defrost, if necessary.
- Check whether samples were inserted into the freezer that may release heat.
- Check the ambient conditions. Protect the freezer from direct sunlight. Ensure sufficient ventilation around the installation location to prevent any buildup of heat in the chamber.
- If these points do not reveal the source of the fault, it may be that the chamber is faulty. Please contact the Service.



If the same alarm recurs, please contact the Service.

### 14.4.3 Door open alarm

The open and closed condition of the chamber door is controlled via the door contact switch. The temperature rises when the door is opened causes the refrigerating machine to turn on.

When the door is opened the alarm occurs after the defined delay time (chap. 13), factory setting: 1 minute.

- Alarm message "Door open", "collective alarm" icon
- Audible alarm (buzzer)
- Switching the zero-voltage relay alarm output

#### Actions:

- Close the outer door.
- Use the **OK button** to switch off the buzzer even when the door is open.
- The alarm message is cancelled.
- The zero-voltage relay alarm output switches off.

### 14.4.4 Power failure alarm

- No alarm message (display is off)  
You can turn on the display with the **OK button**. It turns off automatically after 10 seconds.
- Audible alarm (buzzer): immediately
- Switching the zero-voltage relay alarm output.



**WARNING:** If customer should use a chamber running in non-supervised continuous operation, we strongly recommend in case of inclusion of irrecoverable specimen or samples to split such specimen or samples and store them in at least two chambers, if this is feasible.

## 14.4.5 Messages on the battery management system

The alarms and information messages occur immediately.

### **Battery operation**

- Alarm message “Battery operation”, “collective alarm” icon
- Audible alarm (buzzer)
- Switching the zero-voltage relay alarm output
- The message occurs on battery power (during power failure) after pressing the **OK button** (see chap. 10.3)

There is sufficient battery voltage.

### **Battery missing, completely empty (< 3V) or defective.**

- Alarm message “Battery defective”, “collective alarm” icon
- Audible alarm (buzzer)
- Switching the zero-voltage relay alarm output

The message occurs on line power when no battery has been recognized.

#### **Actions:**

- With defective battery: replace battery.
- Reset alarm message. It will not reset automatically.

### **Low battery voltage**

Information message “Low battery voltage”, “Information” icon

The message occurs on battery power and line power.

Battery voltage is very low (< 12 V). If this message lasts for more than 2 hours, the battery can be defective.

#### **Actions:**

- Check the power supply.
- Check the charging voltage in the controller menu (chap. 18.2)
- With defective battery: replace battery. Contact the Service.
- Reset alarm message. It will not reset automatically.

## 14.4.6 Messages referring to temperature sensor failure

The alarms occur immediately.

- Audible alarm (buzzer)
- Switching the zero-voltage relay alarm output

### **Failure of the temperature sensor for interior measurement:**

- Alarm message "Inner temp. sensor", "collective alarm" icon
- Cause: defective inner temperature sensor
- Temperature control continues using the safety controller temperature sensor

### **Failure of the safety controller temperature sensor:**

- Alarm message "Safety control sensor", "collective alarm" icon
- Cause: defective safety controller temperature sensor

### **Failure of both the temperature sensors for interior measurement and the safety controller:**

- Temperature display shows " - - - - " or " <-<-< " or " >->-> "
- Alarm messages "Inner temp. sensor" and "Safety control sensor" alternating, "collective alarm" icon
- Cause: both the temperature sensors for interior measurement and the safety controller are defective
- Refrigeration is turned on permanently.

### **Failure of temperature sensors of the refrigerating machine:**

- Alarm message "Condensate temp. sensor", "collective alarm" icon  
Cause: defective temperature sensor on the condenser of the refrigerating machine
- Alarm message "Cascade temp. sensor", "collective alarm" icon  
Cause: defective temperature sensor on the cascade of the refrigerating machine  
If this sensor fails, refrigeration is turned on permanently
- Alarm message "Ambient temp. sensor", "collective alarm" icon  
Cause: defective temperature sensor for ambient temperature or air intake of the 1<sup>st</sup> stage cooling

### **Actions:**

- Please contact the Service.
- If the temperature rises, i.e. the refrigerating machine is defective (safety controller temperature alarm and / or temperature range alarm):
  - Transfer the material to another freezer.
  - Turn off the freezer.
  - If necessary, clean and disinfect the freezer.

## 14.4.7 Messages referring to CO<sub>2</sub> emergency cooling (option CO<sub>2</sub> emergency cooling)

The alarms and information messages occur immediately.

### **CO<sub>2</sub> emergency cooling is activated**

- No message, icon for function 1 is shown (chap. 20.3.2)

### **CO<sub>2</sub> emergency cooling is running (test run)**

Information message "CO<sub>2</sub> cooling test active", information icon

Cause: CO<sub>2</sub> emergency cooling test run has been activated in the controller (chap. 20.3.3)

#### **Actions:**

If desired, deactivate CO<sub>2</sub> emergency cooling test run in the controller (chap. 20.3.3)

### **CO<sub>2</sub> emergency cooling is running (power failure)**

- Alarm message "CO<sub>2</sub> emergency cooling", collective alarm icon
- Audible alarm (buzzer)
- Switching the zero-voltage relay alarm output

Cause: Power failure. Activated CO<sub>2</sub> emergency cooling automatically turned on and is running.

### **Insufficient CO<sub>2</sub> supply of the CO<sub>2</sub> emergency cooling system**

- Alarm message "CO<sub>2</sub> pressure", collective alarm icon
- Audible alarm (buzzer)
- Switching the zero-voltage relay alarm output

Cause: emergency cooling has been activated, CO<sub>2</sub> connection pressure is too low.

#### **Actions:**

- Check if the CO<sub>2</sub> gas supply is open
- Connect a new pressurized CO<sub>2</sub> cylinder



It is not possible to determine the filling level of a pressurized CO<sub>2</sub> cylinder from the cylinder pressure. Weigh the bottle regularly in order to replace it in time

### **Low battery voltage during CO<sub>2</sub> emergency cooling with battery operation**

- Information message "Low battery voltage", information icon.
- Battery voltage is very low (< 12 V).

#### **Actions:**

- Check the battery connections
- Charge the battery (charging mode: current, approx. 160 mA)
- If it is defective, replace the battery. Contact the Service.
- Reset the alarm message.

## 14.5 Zero-voltage relay alarm output

### Collective alarm output via the zero-voltage relay alarm contact

The SUFsg freezer is equipped at the rear with a zero-voltage relay output (9), which permits the transmission of alarms to an external monitoring system in order to monitor and record the alarm signals.

The zero-voltage relay alarm output switches immediately, as soon as the "Collective alarm" icon lights up. The zero-voltage relay alarm output switches for all alarm instances and in case of a power failure.

If the external alarm monitor is connected via the contacts COM and NO, alarm monitoring will take place with protection against short-circuiting, i.e., if the connection between the freezer and the external alarm monitor is interrupted, an alarm is triggered. In this case, power failure will also trigger the alarm.

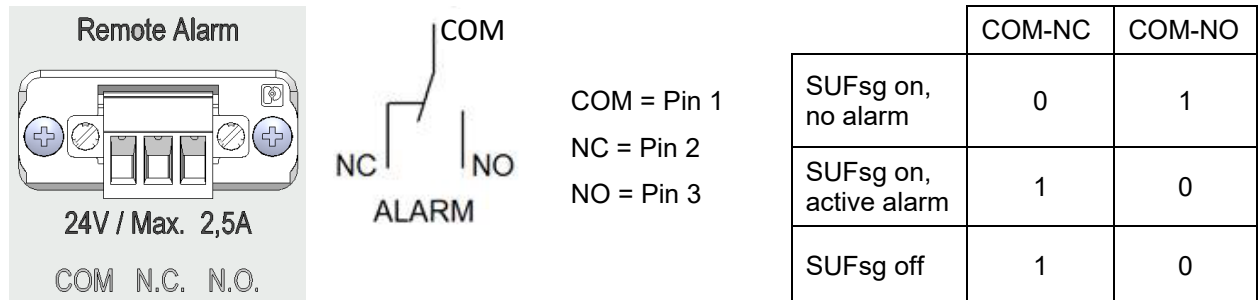

Figure 18: Zero-voltage contacts circuit diagram and pin allocation of the socket (9)

When the chamber is running and there is no alarm, contact COM closes with contact NO.

When the chamber is turned off or if there is an active alarm, contact COM closes with contact NC.

Closing contact COM with contact NC switches the zero-voltage relay alarm output.

**Maximum loading capacity of the switching contacts: 24V AC/DC – 2.0 Amp.**

	<b>DANGER</b>
	<p><b>Electrical hazard through overload of switching contacts.</b>  <b>Deadly electric shock, damage to switching contacts and connection socket.</b></p> <ul style="list-style-type: none"> <li>∅ Do NOT exceed the maximum switching load of 24V AC/DC – 2.0 Amp.</li> <li>∅ Do NOT connect any devices with a higher loading capacity.</li> </ul>

The alarm message on the controller display remains displayed during transmission of an alarm via the zero-voltage relay outputs. As soon as the cause of the alarm is rectified, or the alarm message has been reset, the alarm transmission via the zero-voltage relay outputs is reset together with the alarm message on the controller display.

In case of power failure, transmission of the alarm via zero-voltage relay outputs remains active for the duration of the power failure. Afterwards, the contact closes automatically.

### Connection to an external monitoring system

To ensure short-circuit-proof alarm monitoring that will trigger the alarm when the freezer is connected to an external alarm monitor, connect the external alarm monitoring system to the freezer via the connection socket (9) of the zero-voltage relay output.



## 15. Ethernet network settings

The settings of this submenu are used for networking chambers with an Ethernet interface, e.g. to connect them with a computer.

### 15.1 Showing the network settings

Required access level: "User".

The "Ethernet" submenu offers to subsequently or individually access the following information:

- MAC address
- IP address
- Subnet mask
- Standard gateway
- DNS server address
- DNS chamber name

#### 15.1.1 Showing the chamber's MAC address

Path: **Normal display** ▾ ▾ **Chamber info**  ▾ ▾ ▾ ▾ ▾ **Ethernet**  **MAC address**

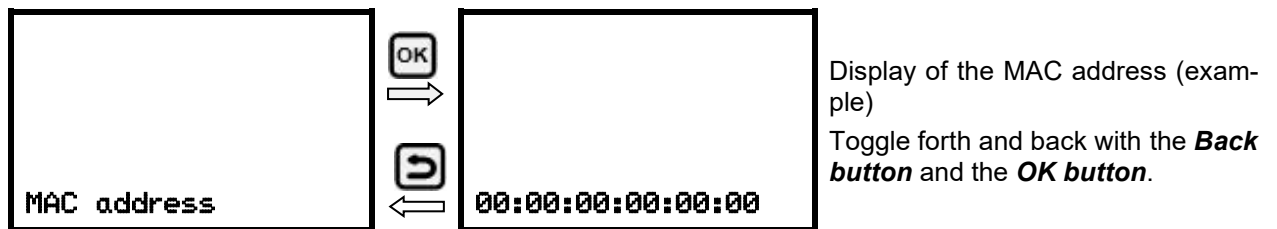

With the **arrow-down button** you can now change to the next parameter (IP address).

With the **Back button** you can go back to the "Ethernet" submenu and, repeatedly pressing it, to **Normal display**.

#### 15.1.2 Showing the IP address

Path: **Normal display** ▾ ▾ **Chamber info**  ▾ ▾ ▾ ▾ ▾ **Ethernet**  **IP address**

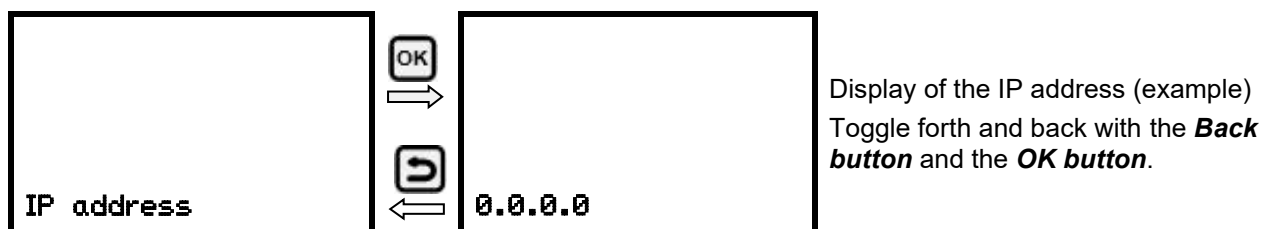

With the **arrow-down button** you can now change to the next parameter (subnet mask).

With the **Back button** you can go back to the "Ethernet" submenu and, repeatedly pressing it, to **Normal display**.

## 15.1.3 Showing the subnet mask

Path: **Normal display** ▾ ▾ **Chamber info** OK ▾ ▾ ▾ ▾ ▾ **Ethernet** OK ▾ ▾ **Subnet mask**



With the **arrow-down button** you can now change to the next parameter (standard gateway).

With the **Back button** you can go back to the “**Ethernet**” submenu and, repeatedly pressing it, to **Normal display**.

## 15.1.4 Showing the standard gateway

Path: **Normal display** ▾ ▾ **Chamber info** OK ▾ ▾ ▾ ▾ ▾ **Ethernet** OK ▾ ▾ ▾ **Standard gateway**

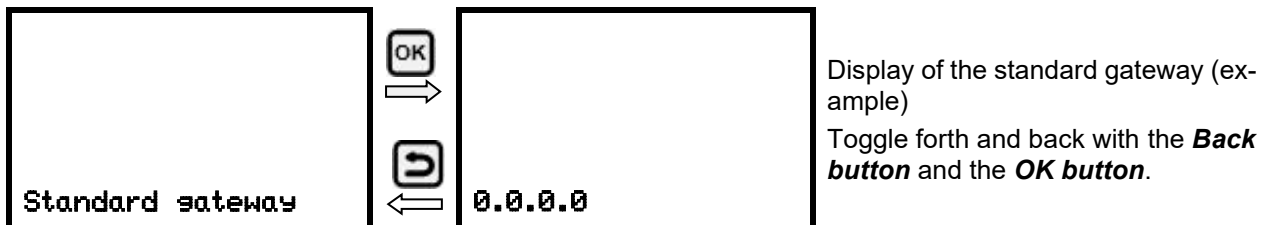

With the **arrow-down button** you can now change to the next parameter (DNS server address).

With the **Back button** you can go back to the “**Ethernet**” submenu and, repeatedly pressing it, to **Normal display**.

## 15.1.5 Showing the DNS server address

Path: **Normal display** ▾ ▾ **Chamber info** OK ▾ ▾ ▾ ▾ ▾ **Ethernet** OK ▾ ▾ ▾ ▾ **DNS server address**

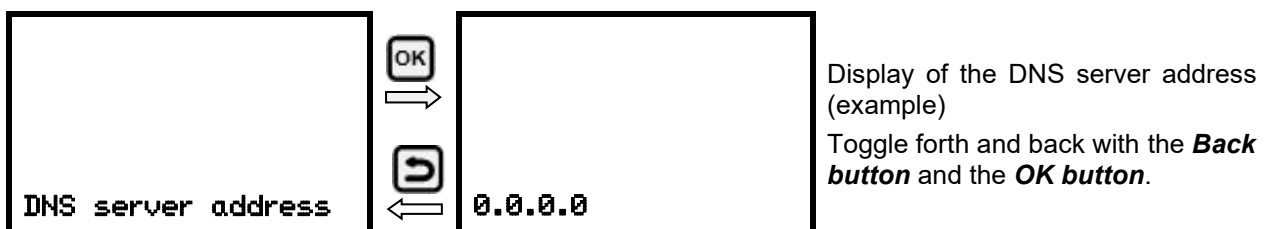

With the **arrow-down button** you can now change to the next parameter (DNS chamber name).

With the **Back button** you can go back to the “**Ethernet**” submenu and, repeatedly pressing it, to **Normal display**.

## 15.1.6 Showing the DNS chamber name

Path: **Normal display** ▾ ▾ **Chamber info** OK ▾ ▾ ▾ ▾ ▾ **Ethernet** OK ▾ ▾ ▾ ▾ ▾ **DNS**



With the **Back button** you can go back to the “**Ethernet**” submenu and, repeatedly pressing it, to **Normal display**.

## 15.2 Changing the configuration of the network settings

Required access level: “Admin”.

The “Ethernet” submenu offers to subsequently or individually access the following settings:

- Selecting the type of assignment (automatic or manual) of the IP address, chap. 15.2.1

If automatic IP address assignment has been selected:

- Selecting the type of assignment (automatic or manual) of the DNS server address, chap. 15.2.2

If manual IP address assignment has been selected:

- Assigning the IP address, chap. 15.2.3
- Assigning the subnet mask, chap. 15.2.4
- Assigning the standard gateway, chap. 15.2.5

If manual IP address assignment or manual DNS server address assignment has been selected:

- Assigning the DNS server address, chap. 15.2.6

### 15.2.1 Selecting the type of IP address assignment (automatic / manual)

Path: **Normal display** ▾ ▾ ▾ **Settings** OK ▾ **Ethernet** OK **IP address assignment**

Press the **OK button** to enable the setting

Selection of the type of assignment of the IP address.  
The current setting flashes. Use the **arrow buttons** to select between AUTO (automatic) and MANU (manual).  
Confirm the setting with the **OK button**.

With the **arrow-down button** you can now change to the next parameter.

- If manual IP address assignment has been selected: assign the IP address (chap. 15.2.3)
- If automatic IP address assignment has been selected: select the type of assignment of the DNS server address (chap. 15.2.2).

With the **Back button** you can go back to the “**Ethernet**” submenu and, repeatedly pressing it, to **Normal display**.

## 15.2.2 Selecting the type of assignment of the DNS server address (automatic / manual)

Access to this function is possible only if automatic IP address assignment has been selected (chap. 15.2.1).

Path: **Normal display**    **Settings**   **Ethernet**    **DNS server**

Press the **OK button** to enable the setting.

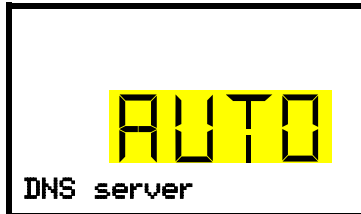

Selection of the type of assignment of the DNS server address.

The current setting flashes. Use the **arrow buttons** to select between AUTO (automatic) and MANU (manual).

Confirm the setting with the **OK button**.

If manual assignment of the DNS server address has been selected, you can now change with the **arrow-down button** to assign the DNS server address (chap. 15.2.6).

With the **Back button** you can go back to the "Ethernet" submenu and, repeatedly pressing it, to **Normal display**.

## 15.2.3 Assigning the IP address

Access to this function is possible only if manual IP address assignment has been selected (chap. 15.2.1)

Path: **Normal display**    **Settings**   **Ethernet**    **IP address**

Press the **OK button** to enable the setting.

The IP address entry is done in four steps, corresponding to the number sections: (1).(2).(3).(4)

Principle of entry:

- Use the **OK button** to select the desired section of the IP address 1/4, 2/4, 3/4, 4/4 in the upper display line
- Use the **Arrow buttons** to enter the value for the selected section of the IP address



IP address assignment (sample values).

The first section of the IP address is shown. Enter the desired value with the **arrow buttons**.

Use the **OK button** to confirm the entry and proceed to the second section of the IP address.

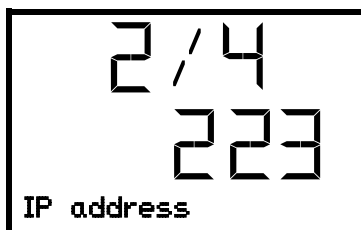

IP address assignment (sample values).

The second section of the IP address is shown. Enter the desired value with the **arrow buttons**.

Use the **OK button** to confirm the entry and proceed to the third section of the IP address.



IP address assignment (sample values).

The third section of the IP address is shown. Enter the desired value with the **arrow buttons**.

Use the **OK button** to confirm the entry and proceed to the last section of the IP address.

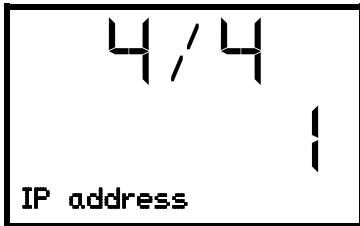

IP address assignment (sample values).

The fourth section of the IP address is shown. Enter the desired value with the **arrow buttons**.

Confirm the setting with the **OK button**.

With the **arrow-down button** you can now change to the enter the subnet mask.

With the **Back button** you can go back to the “Ethernet” submenu and, repeatedly pressing it, to **Normal display**.

## 15.2.4 Setting the subnet mask

Access to this function is possible only if manual IP address assignment has been selected (chap. 15.2.1)

Path: **Normal display**    **Settings**   **Ethernet**     **Subnet mask**

Press the **OK button** to enable the setting.

The subnet mask entry is done in four steps, corresponding to the number sections: (1).(2).(3).(4)

Principle of entry:

- Use the **OK button** to select the desired section of the subnet mask 1/4, 2/4, 3/4, 4/4 in the upper display line
- Use the **Arrow buttons** to enter the value for the selected section of the subnet mask

For details please refer to the description of the similar procedure in chap. 15.2.3 “Assigning the IP address”.

With the **arrow-down button** you can now change to the enter the standard gateway.

With the **Back button** you can go back to the “Ethernet” submenu and, repeatedly pressing it, to **Normal display**.

## 15.2.5 Setting the standard gateway

Access to this function is possible only if manual IP address assignment has been selected (chap. 15.2.1)

Path: **Normal display**    **Settings**   **Ethernet**     **Standard gateway**

Press the **OK button** to enable the setting.

The standard gateway entry is done in four steps, corresponding to the number sections: (1).(2).(3).(4)

Principle of entry:

- Use the **OK button** to select the desired section of the standard gateway 1/4, 2/4, 3/4, 4/4 in the upper display line
- Use the **Arrow buttons** to enter the value for the selected section of the standard gateway
- For details please refer to the description of the similar procedure in chap. 15.2.3 “Assigning the IP address”.

With the **arrow-down button** you can now change to the assign the DNS server address.

With the **Back button** you can go back to the “Ethernet” submenu and, repeatedly pressing it, to **Normal display**.

## 15.2.6 Assigning the DNS server address

Access to this function is possible if manual IP address assignment (chap. 15.2.1) or manual DNS server address assignment (chap. 15.2.2) has been selected.

With manual IP address assignment:

Path: **Normal display** [▼] [▼] [▼] **Settings** [OK] [▼] **Ethernet** [OK] [▼] [▼] [▼] **DNS server address**

With manual DNS server address assignment:

Path: **Normal display** [▼] [▼] [▼] **Settings** [OK] [▼] **Ethernet** [OK] [▼] [▼] **DNS server address**

Press the **OK button** to enable the setting.

The DNS server address entry is done in four steps, corresponding to the number sections: (1).(2).(3).(4)

Principle of entry:

- Use the **OK button** to select the desired section of the DNS server address 1/4, 2/4, 3/4, 4/4 in the upper display line
- Use the **Arrow buttons** to enter the value for the selected section of the DNS server address
- For details please refer to the description of the similar procedure in chap. 15.2.3 "Assigning the IP address".

With the **Back button** you can go back to the "**Ethernet**" submenu and, repeatedly pressing it, to **Normal display**.

## 16. Data recorder

An internal data recorder saves chamber data and events in three data sets.

With the export function "Export recorder data" (chap. 17.3) you can save the three data sets via the USB interface to USB stick. They are issued in the selected language as a spreadsheet with the file extension ".csv" and can be further processed in the desired program. The data is unencrypted. Always the entire data memory is read out.

### 16.1 Recorded data

All data is given out in tabular form. The headlines of the values "number", "date", and "time" are given out in the selected language, all other information in English.

- **Chamber data for the user "DL1"**

Tabular representation of the actual temperature value and temperature set-point together with the date and time, according to the set storage rate (chap. 16.3). Temperature values are always given out in °C.

- **Chamber data for the manufacturer's Service "DL2"**

This data is intended for use by the manufacturer's Service. The storage rate is fix (1 minute). Temperature values are always given out in °C.

- **Event list**

Messages regarding the controller and data memory as well as the alarm messages together with the date and time:

- Firmware update done
- "New config (USB)": New configuration uploaded via USB

- “Data recorder cleared”: Data recorder and event list deleted via setup program
- Other event messages according to existing alarms

The moment of switching the alarm state on and off is indicated under “On/Off”.

## 16.2 Storage capacity

The storage capacity of the data recorder depends on the number of entries.

- DL1 = 110.000 entries (equaling 76 days with a storage rate of 1 minute, setting see chap. 16.3)
- DL2 = 27.000 entries (equaling 18 days with a fix storage rate of 1 minute)
- Event list: 200 events

The shorter the set storage rate, the closer are the stored measuring points, the more precise, but also shorter is the documented period.

Once the storage capacity of the data recorder is reached, overwriting of the oldest values begins

## 16.3 Setting the storage rate for the “DL1” recorder data

Required access level: “Admin”.

Path: **Normal display**    **Settings**    **Data recorder**  **Storage interval**

Press the **OK button** to enable the setting.

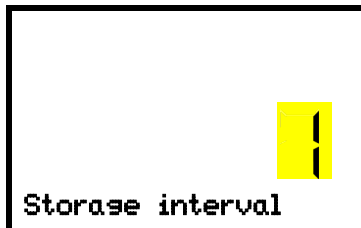

Function “Storage interval”.

The current setting flashes. Use the **arrow buttons** to enter the desired storage interval. Setting range: 1 minute (factory setting) to 60 minutes.

Press the **OK button** to confirm the setting.

With the **Back button** you can go back to the “**Data recorder**” submenu and, repeatedly pressing it, to **Normal display**.

## 16.4 Deleting the data recorder

When importing a configuration via USB stick and when loading a new firmware version by the service, the entire data memory is deleted.

The service can also install the configuration by means of a setup program without deleting the data.

Regardless of this, the manufacturer’s Service can delete the data via a setup program.

Loading a new configuration via USB stick leads to deleting the data recorder.

	NOTICE
	<p><b>Danger of information loss when loading a new configuration via USB stick.</b>  <b>Data loss.</b></p> <p>➤ Backup data before loading a new configuration via USB stick.</p>

## 17. USB-Menu: Data transfer via USB interface

A USB interface for data transfer via USB stick is located in the door lock and controller housing (the second micro USB interface is only used by the manufacturer).

The controller offers an import function and three export functions through the USB interface:

### Import function (chap. 17.2):

- Configuration data in file "KONF380.set"

### Export functions (chap. 17.3):

- Configuration data in file "KONF380.set"
- Recorder data
  - DL1 (chamber data for the user): "DL1\_[MAC address of the chamber].csv"
  - DL2 (chamber data for the manufacturer's Service): "DL2\_[MAC address of the chamber].csv"
  - Event list: "EvList\_[MAC address of the chamber].csv"

For detailed information on the file content see chap. 16.1.

- Service data

The "Service" folder is created on the USB stick and can be sent to the manufacturer's Service. In addition to the configuration and recorder data, it contains further service-relevant information.

### 17.1 Connecting the USB stick

Connect the USB stick to the interface located in the controller housing.



Connect only USB sticks to the USB interface.  
The USB stick must be formatted with FAT32 and have at least 8GB of memory.

After inserting the USB stick, the initial function "Import configuration" is displayed.

As long as the USB stick is connected, only the functions for data transfer are available. Other controller functions are only available after removing the USB stick.

### 17.2 Import function

Required access level: "Admin".



Function "Import configuration".  
To import configuration data from the USB stick, press the **OK button**.

With the **arrow-down button** you can now change to the setting of the "Export configuration" function.



## 17.3 Export functions

Required access level: any user



Function "Export configuration".

To write the configuration data from the controller to the USB stick, press the **OK button**.

With the **arrow-down button** you can now change to the next function.



Function "Export recorder data".

To write the recorder data from the controller to the USB stick, press the **OK button**.

With the **arrow-down button** you can now change to the next function.



Function "Export service data".

To write the chamber data from the controller to the USB stick, press the **OK button**.

## 17.4 Ongoing data transfer

A moving arrow symbol indicates the progress of the data transfer.

Example:



Data recording is running.

Attention! Danger of data loss! Do not disconnect the USB stick from the chamber during ongoing data transfer!

After successful transfer, the controller shows again the initial function "Import configuration".

## 17.5 Error during data transmission

In the event of an error, the message ERR (error) is displayed.



Read error (example).

## 17.6 Removing the USB stick

Logging off the USB stick is not possible / required.

Be sure that no data recording is running (chap. 17.4).

After removing the USB stick, the controller is back in the same menu as before when connecting the USB stick.

## 18. Battery management system

This controller menu serves to check whether the battery is present and which is its current charging state. These are pure display functions without any setting options.







### 18.1 Battery operation

This menu shows whether the chamber voltage is supplied by the battery.

- Display “YES”: Battery operation (during power failure)
- Display “NO”: Battery is charging, external power connection available

If no battery is detected (battery is missing, completely empty (< 3V), or defective, on line power the alarm message “Battery defective” is emitted (chap. 14.4.5).

Required access level: “User”.

Path: **Normal display**   **Chamber info**     **Battery management**  **Battery operation**

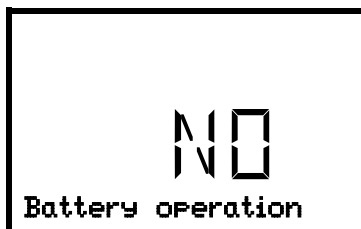

Display “Battery operation”.  
YES = Battery operation, no power connection available  
NO = Battery charging, external power supply

With the **arrow-down button** you can now change to the function “Charging voltage”.

With the **Back button** you can go back to the “**Battery management**” submenu and, repeatedly pressing it, to **Normal display**.

## 18.2 Charging voltage

This menu shows the battery's current charging voltage. The correct voltage is > 12 V.

As soon as the charging voltage falls below the limit value of 12 V, the information message "Low battery voltage" is emitted. This happens on battery power and line power (chap. 14.4.5).

Required access level: "User".

Path: **Normal display** ▾ ▾ **Chamber info**  ▾ ▾ ▾ **Battery management**  ▾ **Charging voltage**



Display of the battery's current charging voltage.

With the **arrow-up button** you can change to the function "Battery operation".

With the **Back button** you can go back to the "**Battery management**" submenu and, repeatedly pressing it, to **Normal display**.

## 19. Setting and activating the service setpoint

To set a lower setpoint value for test purposes or for adjustment, you can enter and activate a service setpoint. This setting is outside the control range and is not intended for normal operation.

Once the service setpoint has been activated, the standard temperature setpoint will have no effect. Only after deactivating the service setpoint, the chamber will equilibrate again to the standard temperature setpoint.

### 19.1 Setting the service setpoint

Required access level: "Admin".

Path: **Normal display** ▾ ▾ ▾ **Settings**  ▾ ▾ ▾ **Various**  ▾ ▾ ▾ **Service setpoint**

Press the **OK button** to enable the setting.

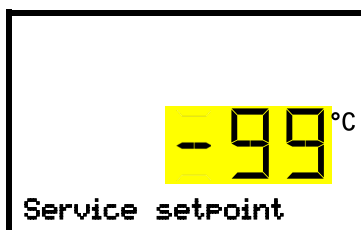

Setting the service setpoint

The current setting flashes. Use the **arrow buttons** to enter the desired value. Entry range: +20 °C up to -99 °C. Factory setting: -99 °C.

Confirm the setting with the **OK button**.

With the **arrow-up button** you can go to setting the alarm limit for range alarm (chap. 13.3).

With the **arrow-down button** you can now change to the Manual Offset setting (chap. 7.1).

With the **Back button** you can go back to the "**Various**" submenu and, repeatedly pressing it, to **Normal display**.

## 19.2 Activating the service setpoint

Required access level: "User".

Path: **Normal display**  **Setpoints**   **Functions on/off**    **Service setpoint on/off**

With optional CO<sub>2</sub> emergency cooling:

Path: **Normal display**  **Setpoints**    **Functions on/off**    **Service setpoint on/off**

Press the **OK button** to enable the setting.



Setting function 3 "Service setpoint on/off".

The current setting flashes. Use the **arrow buttons** to select between "1" (Service setpoint active) and "0" (Service setpoint not active).

Confirm the setting with the **OK button**.

With the **Back button** you can go back to the "**Functions on/off**" submenu and, repeatedly pressing it, to **Normal display**.

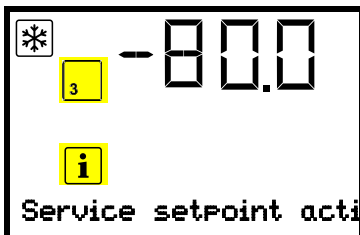

Normal display with the information message "Service setpoint active".

The service setpoint will remain active until manually deactivating function 3 "Service setpoint on/off".

## 20. CO<sub>2</sub> emergency cooling (option for SUFsg 5001, SUFsg 7001)

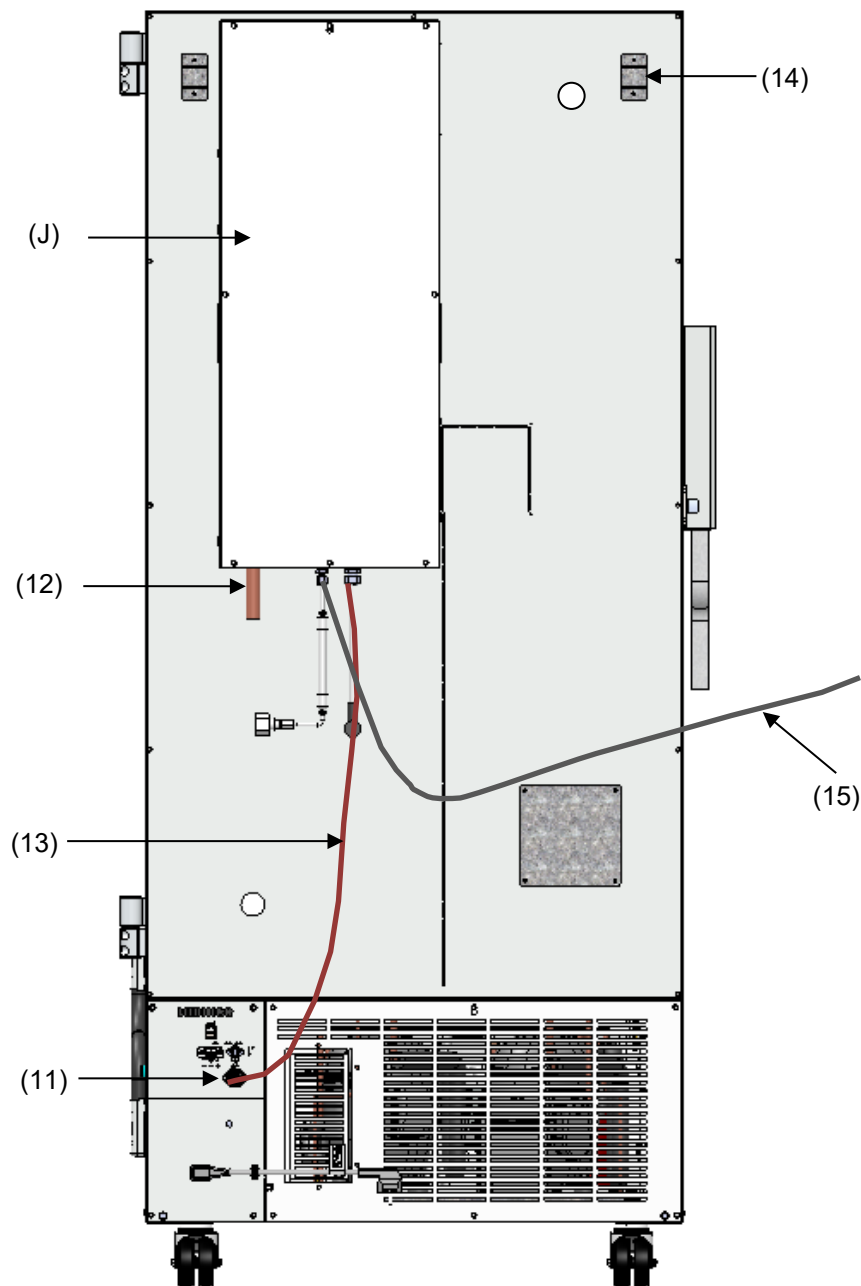

Figure 19: Rear view of SUFsg with CO<sub>2</sub> emergency cooling system

- (J) CO<sub>2</sub> emergency cooling
- (11) Connection socket for the electrical connection of the CO<sub>2</sub> emergency cooling
- (12) CO<sub>2</sub> discharge outlet to connect a discharge hose
- (13) Cable to connection socket (11) for the electrical connection of the CO<sub>2</sub> emergency cooling
- (14) Pressure compensation opening (visible from the inside). Here CO<sub>2</sub> will also escape.
- (15) Gas hose to connect the pressurized CO<sub>2</sub> cylinders

Control and temperature measurement of the chamber controller are used for the CO<sub>2</sub> emergency cooling; therefore, this option cannot be used for ultra-low temperature freezers from other manufacturers.



The optional CO<sub>2</sub> emergency cooling is intended only for the use with this ultra-low temperature freezer SUFsg.

The CO<sub>2</sub> emergency cooling offers additional refrigeration when the inner chamber temperature increased up to the pre-set emergency cooling temperature. This may become necessary, following introduction of a heat load, in case of a power failure or failure of the cooling system.

Principle: CO<sub>2</sub> is taken from the gas bottle in liquid form and introduced into the freezer when required. There the gas expands and cools off intensely, forming a mixture of CO<sub>2</sub> gas and CO<sub>2</sub> snow. The CO<sub>2</sub> snow provides the required cooling capacity through the transition into the gaseous state.

The emergency cooling system is integrated into the safety chain of the chamber. In case of power failure, rechargeable batteries supply the CO<sub>2</sub> emergency cooling power supply, during normal operation power is supplied by a power supply unit 24V DC. The rechargeable battery is designed for an interruption of the external power supply of 72 hours maximum. Therefore, if pressurized CO<sub>2</sub> cylinders are available in sufficient quantity, functioning of the CO<sub>2</sub> emergency cooling should last through a week-end.

You can set the CO<sub>2</sub> emergency cooling system between -40 °C / -40 °F and -70 °C / -94 °F. In order to ensure an emergency cooling time as long as possible with a given CO<sub>2</sub> stock, select the highest possible emergency cooling temperature.

The optional CO<sub>2</sub> emergency cooling system is available as a retrofit kit. Please contact the manufacturer's dealer.



The upper left 28 mm access port (6a) on the rear of the ultra-low temperature freezer serves to connect the CO<sub>2</sub> emergency cooling.

## 20.1 Connecting and exchanging the pressurized CO<sub>2</sub> cylinder



The CO<sub>2</sub> emergency cooling system works exclusively with liquid CO<sub>2</sub>. Use CO<sub>2</sub> dip tube cylinders with a W21.8 x 1 ¼ inch safety valve connection. The maximum ambient temperature for the cylinder must not exceed 35 °C. The dip tube inside enables almost complete liquid withdrawal. CO<sub>2</sub> dip tube cylinders must stand upright during withdrawal.

### Note regarding the installation site of the gas cylinder:

The cooling power decreases with increasing temperature of the liquid CO<sub>2</sub>. Do not install the gas cylinder in the exhaust airflow of the ultra-low temperature freezer.



The supplied gas hose (15) is already connected with the CO<sub>2</sub> emergency cooling system. The user shall not remove this connection. When replacing the gas hose is required, please contact the manufacturer's Service. To connect the pressurized CO<sub>2</sub> cylinder, connect the free end of the gas hose to the gas cylinder (wrench size A/F 30 mm / 1.2 in). Then open the valve of the gas cylinder.

Before changing the gas cylinder, first close the valve of the empty gas cylinder. Perform a test run of the CO<sub>2</sub> emergency cooling to reduce the CO<sub>2</sub> pressure in the emergency cooling system. Only then unscrew the gas hose.







After connecting the gas cylinder, check the hose connection with a soap solution for gas leaks. The hose connection must be tight

The valve of the gas cylinder **always** must be closed before screwing on or unscrewing the gas hose

 	 <b>WARNING</b>
	<p><b>Risk of injury through sudden release of the stored pressure energy when opening the cylinder valve of a not connected cylinder.</b></p> <p><b>Injuries.</b></p> <ul style="list-style-type: none"> <li>➤ Close the gas cylinder valve before connecting or removing the gas hose.</li> </ul>

Secure the pressurized gas cylinder against falling and other mechanical damage.

 	 <b>WARNING</b>
	<p><b>Risk of injury through sudden release of the stored pressure energy when the valve safety is torn off.</b></p> <p><b>Injuries.</b></p> <ul style="list-style-type: none"> <li>➤ Secure gas cylinders against falling (chaining).</li> <li>➤ Transport gas cylinders with a cylinder cart.</li> </ul>

	<p>General information for safe handling of pressurized CO<sub>2</sub> cylinder:</p> <ul style="list-style-type: none"> <li>• Open the gas cylinder valve slowly to avoid pressure surges.</li> <li>• Secure gas cylinders during storage and use against falling (chaining).</li> <li>• Transport gas cylinders with a cylinder cart, do not carry, roll, or throw them.</li> <li>• Always close the valve even with apparently empty cylinders; screw on the cap when not in use. Return gas cylinders with the valve closed.</li> <li>• Do not open gas cylinders by force. Mark them when damaged.</li> <li>• Protect gas cylinders against fire, e.g. do not store together with flammable liquids.</li> <li>• Observe relevant regulations for dealing with pressurized CO<sub>2</sub> cylinder.</li> </ul>
---	---

**Information for the operator** concerning requirements and regulations for use of pressurized gas cylinders in the laboratory (not exhaustive):

A **storage** of pressurized gas cylinder (stockholding, no connection for emptying, storing for later use or for supply to others) in a laboratory without a storage cabinet is generally prohibited. The requirements for fire-protected pressurized gas cylinder cabinets are described in DIN EN 14470-2:2006.

**Provisioning** (reserve cylinders connected to the points intended for emptying or provided for imminent connection) and **using** (provisioning, operating, emptying) of pressurized gas cylinders may also take place outside storage cabinets or storage rooms, provided that the safety requirements are met. This applies to the operation of the CO<sub>2</sub> emergency cooling system.

- Observe all relevant local and national regulations, in particular the requirements for provisioning / emptying the pressurized gas cylinders.
- If there are more than 6 cylinders in the laboratory, they must be placed in cylinder cabinets, special installation rooms or outdoors. After work (freezer turned off) store the cylinders in a safe storage location.
- Perform leakage tests
- Fire extinguishers must be available in order to protect the gas cylinders against heating in case of fire

- Make sure that operating instructions on the connection and exchange of the pressurized gas cylinders are attached in the vicinity of the pressurized gas cylinders. The instructions shall contain all required safety-related information in an intelligible form.
- Laboratories in which compressed gas cylinders are installed must be labeled with the warning sign W019 "Warning of gas cylinders".
- In areas with increased risk of fire, if possible set up gas cylinders outside the rooms and install fix tubing.



Carbon dioxide (CO<sub>2</sub>) in high concentrations (> 4 Vol.-%) is hazardous to health. It is colorless and almost odorless and therefore practically imperceptible. Escaping CO<sub>2</sub> gas is heavier than air and accumulates at the ground or possibly in lower-lying parts of the building. There is danger of suffocation and poisoning. Hazards due to uncontrolled gas release must be effectively avoided.

	<b>DANGER</b>
<p><b>Danger of suffocation and poisoning by high concentration of CO<sub>2</sub> (&gt; 4 Vol.-%). Death by suffocation.</b></p> <ul style="list-style-type: none"> <li>⊘ Operate the CO<sub>2</sub> emergency cooling only in a well-ventilated room.</li> <li>➤ Ensure technical ventilation measures. Install a suitable conduct at the CO<sub>2</sub> discharge outlet of the emergency cooling system.</li> <li>➤ Observe the relevant regulations for handling CO<sub>2</sub>.</li> <li>➤ Close the CO<sub>2</sub> supply when decommissioning the chamber.</li> </ul>	

When installing pressurized CO<sub>2</sub> cylinders take into account the **structure of the building**.

- The installation site must be in a well-ventilated area (**natural ventilation**). For rooms with a with a floor area of ≤ 12 m<sup>2</sup> with solid walls without openings on all sides there are further regulations (max. two 14-liter CO<sub>2</sub> cylinders, Label "suffocation" and prohibition to close the door after entering).
- The installation site must be technically ventilated (**technical ventilation**) with a CO<sub>2</sub> alarm system (**gas warning device**).



We strongly recommend continuous monitoring of the CO<sub>2</sub> concentration in the ambient air of the CO<sub>2</sub> emergency cooling. It must be permanently ensured that the **occupational exposure limit OEL** (formerly maximum permitted workplace concentration) of 0.5 Vol.-% CO<sub>2</sub> is not exceeded.

## 20.2 Operating the CO<sub>2</sub> emergency cooling system

When operating the CO<sub>2</sub> emergency cooling system, the freezer's interior is flooded with CO<sub>2</sub>. CO<sub>2</sub> in high concentrations (> 4 vol.-%) is hazardous to health. It is colorless and almost odorless and therefore practically imperceptible. Operate the CO<sub>2</sub> emergency cooling system only in a well-ventilated room. Released CO<sub>2</sub> gas must be safely led out via good room ventilation or a suitable connection to an exhaust system and through a conduct at the CO<sub>2</sub> discharge outlet (12) on the rear of the emergency cooling system. Observe the occupational exposure limit for CO<sub>2</sub> set by the national authorities. We recommend installing a CO<sub>2</sub> warning system.

Even when CO<sub>2</sub> or systems operated with CO<sub>2</sub> are handled carefully and appropriately, a residual risk remains, which can lead to life-threatening situations under certain circumstances. Therefore, we strongly recommend continuous monitoring of CO<sub>2</sub> concentration in the ambient air of CO<sub>2</sub> emergency cooling. It must be ensured permanently that the maximum permissible occupational exposure limit for CO<sub>2</sub> (0.5 vol.-% CO<sub>2</sub> for Germany) is not exceeded.



	 <b>DANGER</b>
<p><b>Danger of suffocation and poisoning by high concentration of CO<sub>2</sub> (&gt; 4 Vol.-%). Death by suffocation.</b></p> <ul style="list-style-type: none"> <li>⊘ Operate the CO<sub>2</sub> emergency cooling only in a well-ventilated room.</li> <li>➤ Ensure technical ventilation measures. Install a suitable conduct at the CO<sub>2</sub> discharge outlet of the emergency cooling system.</li> <li>➤ Observe the relevant regulations for handling CO<sub>2</sub>.</li> <li>➤ Close the CO<sub>2</sub> supply when decommissioning the chamber.</li> </ul>	

We recommend connecting an exhaust hose to the CO<sub>2</sub> discharge outlet (12) and to conduct it to the outside or to an exhaust system. Since the CO<sub>2</sub> emergency cooling system is also effective in case of a power failure, an uninterruptible power supply is recommended for the exhaust system.

The chamber controller measures and controls the temperature value inside the useable volume. Depending on the increase or decrease of temperature, the controller controls the CO<sub>2</sub> emergency cooling in standard operation and during power failure. As soon as the preselected emergency cooling temperature is reached inside the useable volume, the solenoid valve of the emergency cooling system opens, and liquid CO<sub>2</sub> from the pressurized CO<sub>2</sub> cylinder is injected at intervals into the useable volume. The liquid CO<sub>2</sub> expands until ambient pressure and evaporated into the useable volume. This results in cooling-down the useable volume to the pre-set emergency cooling temperature.

When opening the outer door, CO<sub>2</sub> injection is interrupted. This prevents potential cold burns / frostbite by inflowing CO<sub>2</sub> gas at manipulation inside the freezer.

	<p>After turning on the freezer, the CO<sub>2</sub> emergency cooling is deactivated until the CO<sub>2</sub> emergency cooling setpoint has been reached for the first time.</p>
---	---

When operating the CO<sub>2</sub> emergency cooling, the temperature distribution may deviate from the technical data valid at -80 °C (chap. 26.3).

### Activating the CO<sub>2</sub> emergency cooling

- Open the valve of the CO<sub>2</sub> gas cylinder
- Set the emergency cooling temperature at the controller (chap. 20.3.1)
- Activate the CO<sub>2</sub> emergency cooling at the controller (chap. 20.3.2)
- If desired, perform a test run (chap. 20.3.3).

## 20.3 Settings on the chamber controller

The presence of the CO<sub>2</sub> emergency cooling must be confirmed on the controller so that the following controller menus (chap. 20.3.1 to 20.3.3) are displayed. This is the standard case for chambers equipped with a CO<sub>2</sub> emergency cooling; you can check the setting in the following menu:

Path: **Normal display** [▼] [▼] [▼] **Settings** [OK] [▼] [▼] [▼] **Various** [OK] [▼] [▼] [▼] [▼] **Opt. CO<sub>2</sub> emerg. cooling**

In this menu, setting "1" must be activated.



Menu "Opt. CO<sub>2</sub> emerg. cooling".  
 "1" = CO<sub>2</sub> emergency cooling available  
 "0" = no CO<sub>2</sub> emergency cooling available

In case there is a CO<sub>2</sub> emergency cooling available, but the setting is “0” (no CO<sub>2</sub> emergency cooling available), e.g., as a result of retrofitting, press the **OK button** to enable the setting.

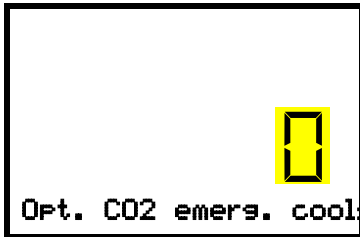

Setting menu “Opt. CO2 emerg. cooling”.

The current setting flashes. Use the **arrow buttons** to change the setting to “1” (CO<sub>2</sub> emergency cooling available).

Confirm the entry with the **OK button**.

Note: For chambers without a CO<sub>2</sub> emergency cooling, the setting must be “0” (no CO<sub>2</sub> emergency cooling available).

The following controller menus are available only with chambers equipped with the enabled optional CO<sub>2</sub> emergency cooling.

### 20.3.1 Setting the CO<sub>2</sub> emergency cooling temperature setpoint



It is recommended to set the CO<sub>2</sub> emergency cooling setpoint by at least 10 °C above the chamber temperature setpoint and above the range alarm limit.

Required access level: “User”.

Path: **Normal display**  **Setpoints**   **CO2 emergency cooling**

Press the **OK button** to enable the setting.

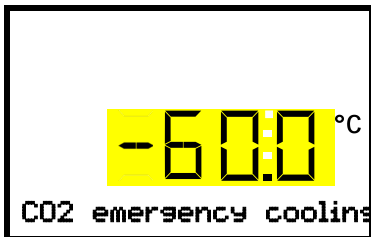

Setting the CO<sub>2</sub> emergency cooling temperature setpoint

The current setting flashes. Enter the desired set-point with the **arrow buttons**. **Setting range:** -30 °C up to -70 °C

Confirm the entry with the **OK button**.

With the **Back button** you can go back to the “**Setpoints**” submenu and, repeatedly pressing it, to **Normal display**.

### 20.3.2 Activating the CO<sub>2</sub> emergency cooling

Required access level: “User”.

Path: **Normal display**  **Setpoints**    **Functions on/off**  **CO2 emer.cooling on/off**

Press the **OK button** to enable the setting.

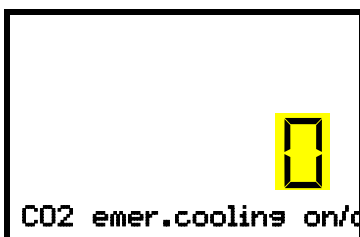

Setting function 1 “CO2 emer.cooling on/off”.

The current setting flashes. Use the **arrow buttons** to select between 0 (deactivated emergency cooling) and 1 (activated emergency cooling).

Confirm the setting with the **OK button**.

With the **Back button** you can go back to the “**Functions on/off**” submenu and, repeatedly pressing it, to **Normal display**.

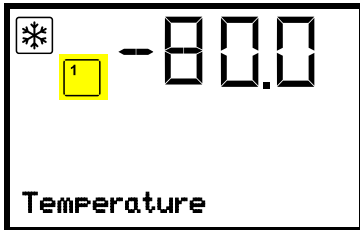

Normal display with activated emergency cooling



Normal display with running emergency cooling, showing the alarm message “CO2 emergency cooling”



The valve of the CO<sub>2</sub> gas cylinder must be open, otherwise pressure alarm will occur.

### Inactivating the CO<sub>2</sub> emergency cooling

1. Inactivate the CO<sub>2</sub> emergency cooling at the controller.
2. Close the valve of the CO<sub>2</sub> gas cylinder.

### 20.3.3 Test run of the CO<sub>2</sub> emergency cooling

You can carry out a test run of the CO<sub>2</sub> emergency cooling at any time, even if the CO<sub>2</sub> emergency cooling is not activated.

The test run of the CO<sub>2</sub> emergency cooling runs after start until it is deactivated again.

Required access level: “User”.

Path: **Normal display** **Setpoints** **Functions on/off** **CO2 cooling test on/off**

Press the **OK button** to enable the setting.



Setting function 2 “CO2 cooling test on/off”.  
The current setting flashes. Use the **arrow buttons** to select between 0 (deactivated test run) and 1 (activated test run).  
Confirm the setting with the **OK button**.

With the **Back button** you can go back to the “**Functions on/off**” submenu and, repeatedly pressing it, to **Normal display**.

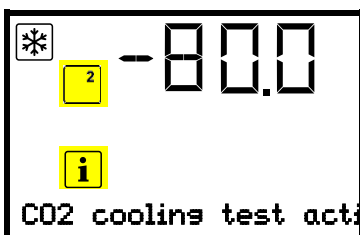

Normal display during test run of the CO<sub>2</sub> emergency cooling, showing the information message “CO2 cooling test active”.

After performing a test run, deactivate the setting again.

## 21. Data monitoring and recording

### 21.1 Ethernet interface

The chamber is regularly equipped with an Ethernet interface (8) for computer communication that can be used to establish a connection for data exchange and recording. The MAC Address is indicated in the "Ethernet" controller menu (chap. 15.1.1).

### 21.2 Analog output for temperature (option)

With this option the freezer is equipped with an analog output 4-20 mA for temperature. This output permits transmitting data to external data registration systems or devices.

The connection is realized as a DIN socket (10) in the rear connection panel as follows:

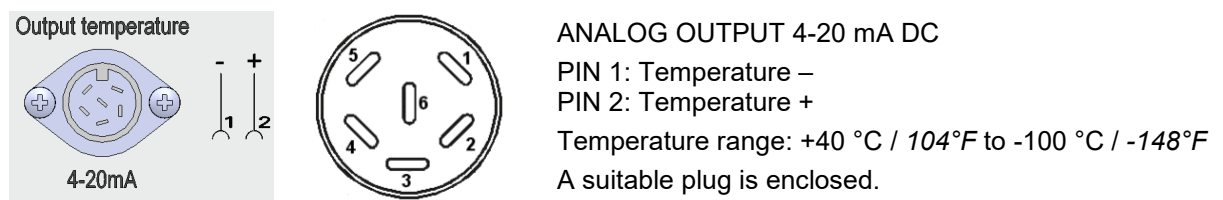

Figure 20: Pin allocation of socket (10) for option analog output

## 22. Chamber inventory: Storage rack systems and cryo boxes (option)

### 22.1 Storage rack systems with or without cryo boxes

For optimum use of the available space of the freezer compartments, the following racks are available:

- Side access racks, aluminum or stainless steel
- Sliding drawer racks, stainless steel



Side access racks with cryo boxes



Sliding drawer racks with smoothly running drawers and cryo boxes

Figure 21: Storage rack systems and cryo boxes

All racks are available in two different heights:

- 280 mm / 11 in height for 5 standard cryo boxes (50 mm / 2 in) stacked
- 330 mm / 13 in height for 6 standard cryo boxes (50 mm / 2 in) stacked

Racks are optionally empty or filled with standard cryo boxes

The cardboard cryo boxes come with a divider (9 x 9 grid for 81 samples).

Rack height	No. of sections for cryo boxes (height x depth)	Cryo boxes	Side access rack, stainless steel Art. no.	Side access rack, aluminum Art. no.	Sliding drawer, stainless steel Art. no.
280 mm / 11 in	5 x 4	empty	7790 027	7790 003	7790 031
280 mm / 11 in	5 x 4	with boxes	7790 029	7790 015	7790 033
330 mm / 13 in	6 x 4	empty	7790 028	7790 014	7790 032
330 mm / 13 in	6 x 4	with boxes	7790 030	7790 025	7790 036

### 22.2 Cryo boxes

Set of 36 standard cryo boxes, cardboard, white, height 50 mm / 2 in with 9 x 9 grid







Figure 22: Cryo boxes with dividers, Art. no. 7790-038

## 23. Cleaning and decontamination

Clean the chamber after each use to avoid potential corrosion damage by ingredients of the charging material.

Prior to renewed startup, allow the chamber to completely dry after all cleaning and decontamination measures.

During operation: Wipe only the outer surfaces with a humid cloth and then dry it thoroughly

	 <b>DANGER</b>
	<p><b>Electrical hazard by water entering the chamber.</b>  <b>Deadly electric shock.</b></p> <ul style="list-style-type: none"> <li>Ø Do NOT spill water or cleaning agents over the inner and outer chamber surfaces.</li> <li>Ø Do NOT put ANY cleaning aids (cloth or brush) into slots or openings on the chamber.</li> <li>➤ Before cleaning, turn off the chamber at the main power switch and disconnect the power plug.</li> <li>➤ Completely dry the chamber before turning it on again.</li> </ul>
	
	

### 23.1 Cleaning

Disconnect the chamber from the power supply before cleaning. Disconnect the power plug.

	The interior of the chamber must be kept clean. Thoroughly remove any residues of the charging material.
---	--

Wipe the surfaces with a moistened towel. In addition, you can use the following cleaning agents (apply on a cloth):

Exterior surfaces, door lock and controller housing with controller panel, interior (stainless steel), shelves, door gaskets	Standard commercial cleaning detergents free from acid or halides. Alcohol based solutions. Neutral cleaning agents.
Connection panel on the chamber rear	Standard commercial cleaning detergents free from acid or halides. Neutral cleaning agents.
Zinc coated hinge parts rear chamber wall	Standard commercial cleaning detergents free from acid or halides. Do NOT use a neutral cleaning agent on zinc coated surfaces.



Do not use cleaning agents that may cause a hazard due to reaction with components of the chamber or the charging material. If there is doubt regarding the suitability of cleaning products, please contact the manufacturer's service.

	<p>Any corrosive damage that may arise following use of other cleaning agents is excluded from liability by the manufacturer.</p> <p>Any corrosive damage caused by a lack of cleaning, is excluded from liability by the manufacturer.</p>
---	---

	NOTICE
	<p><b>Danger of corrosion by using unsuitable cleaners.</b>  <b>Damage to the chamber.</b></p> <ul style="list-style-type: none"> <li>Ø Do NOT use acidic or chlorine cleaning detergents.</li> <li>Ø Do NOT use a neutral cleaning agent on the zinc coated hinge parts or the rear chamber wall.</li> </ul>

	<p>For surface protection, perform cleaning as quickly as possible.          After cleaning completely remove cleaning agents from the surfaces with a moistened towel.          Let the chamber dry.</p>
---	---

	<p>Soapsuds may contain chlorides and must therefore NOT be used for cleaning.</p>
---	--







 	 <b>DANGER</b>
	<p><b>Risk of locking in a person.</b>  <b>Death from suffocation or freezing.</b></p> <ul style="list-style-type: none"> <li>➤ Before closing doors, make sure that nobody is inside.</li> <li>➤ Pull the power plug before entering the interior (e.g. for cleaning purposes).</li> </ul>

	<p>With every cleaning method, always use adequate personal safety controls.</p>
---	--

Following cleaning, leave the chamber door open or remove the access port plugs.

	<p>Neutral cleaning agents may cause health problems in contact with skin and if ingested. Follow the operating instructions and safety hints labeled on the bottle of the neutral cleaning agent.</p>
---	--

Recommended precautions: To protect the eyes use sealed protective goggles. Wear gloves. Suitable protective gloves in full contact with media: butyl or nitrile rubber, penetration time >480 minutes.

    	 <b>CAUTION</b>
	<p><b>Danger of chemical burns through contact with skin or ingestion of the neutral cleaning agent.</b>  <b>Skin and eye damage. Environmental damage.</b></p> <ul style="list-style-type: none"> <li>Ø Do not ingest a neutral cleaning agent. Keep it away from food and beverages.</li> <li>Ø Do NOT empty the neutral cleaning agent into drains.</li> <li>➤ Wear protective gloves and goggles.</li> <li>➤ Avoid skin contact with the neutral cleaning agent.</li> </ul>

	<p>The door handle, door hinges and the locking counterpart must be cleaned at least once a year</p>
---	--

## 23.2 Decontamination / chemical disinfection

The operator must ensure that proper decontamination is performed in case a contamination of the chamber by hazardous substances has occurred.

Disconnect the chamber from the power supply prior to chemical decontamination. Disconnect the power plug.



Do not use decontamination agents that may cause a hazard due to reaction with components of the chamber or the charging material. If there is doubt regarding the suitability of cleaning products, please contact the manufacturer's service.

	Any corrosive damage that may arise following use of other disinfectants is excluded from liability by the manufacturer.
---	--

	With every decontamination method, always use adequate personal safety controls.
---	--

	In case of eye contact, the disinfectant spray may cause eye damage due to chemical burns. Follow the operating instructions and safety hints labeled on the bottle of the disinfectant spray.
---	--

Recommended precautions: To protect the eyes use sealed protective goggles.

	 <b>CAUTION</b>
<p><b>Danger of chemical burns through eye contact with the disinfectant spray.</b></p> <p><b>Eye damage. Environmental damage.</b></p> <ul style="list-style-type: none"> <li>⊘ Do NOT empty the disinfectant spray into drains.</li> <li>➤ Wear protective goggles.</li> </ul>	

	After using the disinfectant spray, allow the chamber to dry thoroughly, and aerate it sufficiently.
---	--

Alternatively, you can use the following disinfectants (apply on a cloth):

Interior (stainless steel)	Standard commercial surface disinfectants free from acid or halides (not dripping). Alcohol based solutions.
Compartment doors	Standard commercial surface disinfectants free from acid or halides (not dripping). Alcohol based solutions max. 10%
Outer door gasket (PVC) and inner door gasket (silicon)	Alcohol based solutions

	Following use, completely remove any disinfectant with a sterile moistened towel from the surfaces.
---	---

Before start-up, the chamber must be absolutely dry and ventilated, as explosive gases may form during the decontamination process.



## 24. Maintenance and service, service, troubleshooting, repair, testing

### 24.1 General information, personnel qualification

- **Maintenance**

See chap. 24.3.

- **Maintenance work by the customer**

This work must be carried out regularly by the operating personnel to maintain the chamber function (chap. 24.2).

For personnel requirements please refer to chap. 1.1.

- **Simple troubleshooting**

Chap. 24.3 describes troubleshooting by operating personnel. It does not require technical intervention into the chamber, nor disassembly of chamber parts.

For personnel requirements please refer to chap. 1.1.

- **Detailed troubleshooting**

If errors cannot be identified with simple troubleshooting, further troubleshooting must be performed by the manufacturer's Service or by service partners or technicians qualified by the manufacturer, in accordance with the description in the Service Manual.

For personnel requirements please refer to the Service Manual.

- **Repair**

Repair of the chamber can be performed by the manufacturer's Service or by service partners or technicians qualified by the manufacturer, in accordance with the description in the Service Manual.

After maintenance, the chamber must be tested prior to resuming operation.

- **Electrical testing**

To prevent the risk of electrical shock from the electrical equipment of the chamber, an annual repeat inspection as well as a test prior to initial startup and prior to resuming operation after maintenance or repair, are required. This test must meet the requirements of the competent public authorities. We recommend testing under EN 50678/VDE 0701 and EN 50699/VDE 0702 in accordance with the details in the Service Manual.

For personnel requirements please refer to the Service Manual

## 24.2 Maintenance work by the customer

### 24.2.1 Checking and cleaning / replacing the condenser air filter

The condenser air filter prevents accumulation of dust on the condenser. If the filter is blocked by dust this may cause decrease or failure of refrigeration.

Check the air filter visually for soiling every month. Especially with the alarm message "Condenser temp." (chap. 14.1) the filter may be soiled. You can rinse the filter and use it again.



Regularly check the filter visually for soiling.

The filter is located behind the cover flap (E) in the lower housing cover. You can easily take it out for cleaning or replacement.

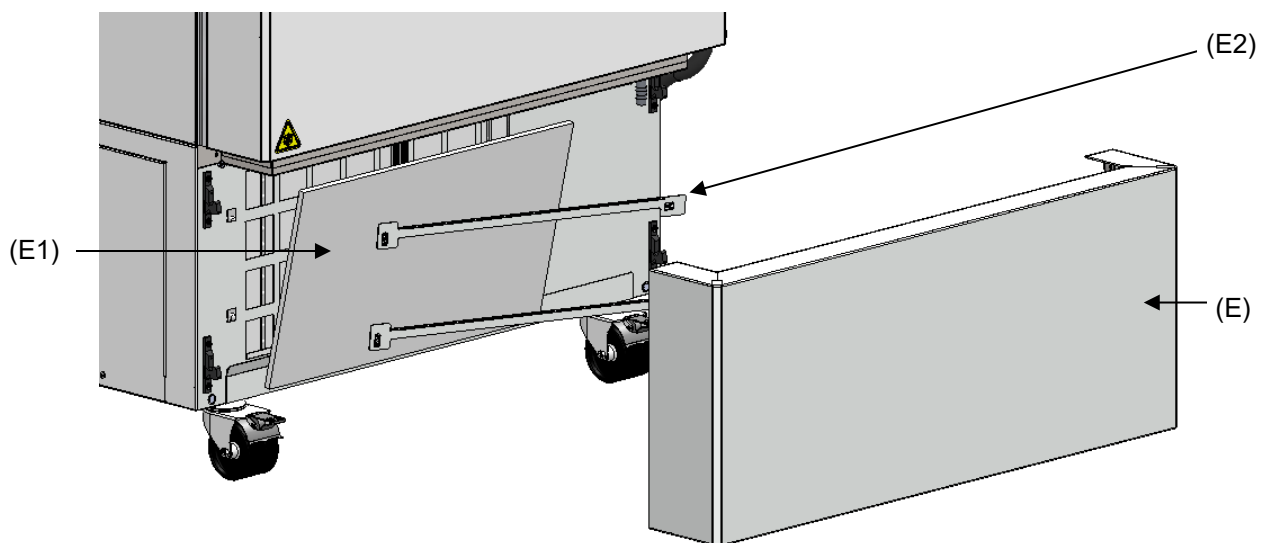

Figure 23: Removing the condenser air filter

(E) cover flap

(E1) condenser air filter

(E2) fixing bars

- Pull the cover flap (E) forward and remove it from the chamber
- Lift the fixing bars (E2) and pull them off to the left
- Remove the condenser air filter (E1)
- Wash the condenser air filter with water and let it dry. If necessary, replace the filter.
- Insert the condenser air filter and then the fixing bars (E2)
- Mount the air filter flap (E).



Fix the condenser air filter, the fixing bars, and the cover flap correctly following cleaning or replacement of the filter.

## 24.2.2 Cleaning the condenser

Every 6 months remove by suction any visible dust on the condenser lamellas with a vacuum cleaner. If appropriate, blow through the lamellas with compressed air.

With an increased amount of dust in the ambient air, clean the condenser several times a year. In this case we recommend to weekly check the condenser lamellas (behind the cover flap (E)). If soiling is visible, turn off the chamber and remove the dust by suction from the condenser lamellas.

## 24.2.3 De-icing and defrosting



We recommend for material that could be damage already by slight warming, to provide adequate storage facilities (e.g., in a second chamber / with liquid nitrogen).

Ice may form at the upper part of the chamber and on the inner doors. Excessive frost may lead to increasing the inner chamber temperature. Remove the frost on the doors with an ice scraper.



Regularly (recommendation: every month) remove the frost on the doors with an ice scraper.

Note: If the door has not been opened for a longer period of time (more than 5 days), it is advisable to de-ice the door gaskets and the inner opening of the pressure compensation valve (I). After that, the door can be opened even after a short period of time without applying great force.

After an extended period of operation, defrosting may become necessary:

To defrost the entire chamber, proceed as follows:

- Turn off external protocol systems (option) if applicable.
- Place the stored material in another freezer or in a container refrigerated by dry ice or liquid carbon dioxide.
- Turn off the chamber at its main power switch (4) and disconnect it from the power supply.
- Open the outer door and all inner doors.
- Allow the frost to melt.



### NOTICE

**Risk of damage to the interior and to components of the refrigeration system through scraping and piercing with a sharp instrument.**

**Damage to the chamber.**

- Ø NEVER use tools with a sharp edge to remove the frost.
- Ø Do NOT use mechanical tools or other aids to accelerate defrosting.
- Only use the tools recommended by the manufacturer.

- Wipe up the remains of the defrost water in the interior with absorbent towels
- Let the interior of the freezer dry. Clean and decontaminate it as described in chap. 23



When taking the chamber into operation again, please follow the hints given in chap. 6.2.

- Connect the freezer to the power supply and turn it on with the main power switch (4).
- Operate the chamber for at least 9 hours. Then introduce the material into the freezer.
- Turn on external protocol systems if applicable.

When defrosting, water may accumulate on the shelves and the bottom. Procedure to remove it:

- Carry the water from the freezer shelves and bottom with a wiper into the drain well.
- Then dry all inner chamber equipment with an absorbent towel.

### Using the drain well for condensate

The drain well collects the dripping water when defrosting. It is located behind the cover flap (E). During operation, the hole in the drain well is closed with a plug.

It is required to remove the cover flap (E) for defrosting.

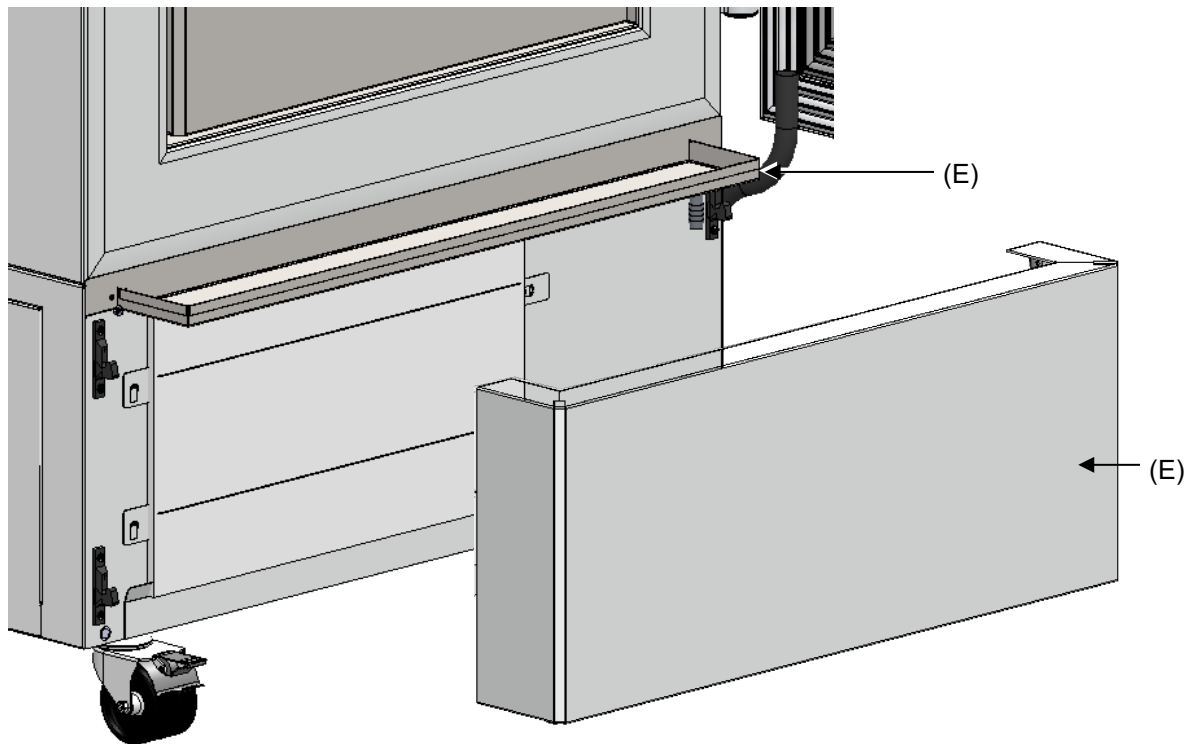





Figure 24: Freezer with drain well in defrosting position

- Turn off the freezer.
- Pull the cover flap (E) forward and remove it from the chamber
- Open the door slightly. Now the melted condensate flows into the drain well.
- Place a reservoir below the hole at the front right corner of the drain well and pull out the plug, so that the water can drain off.
- After defrosting, close the hole with the plug and insert the cover flap (E).

### 24.2.4 Maintenance of the door lock

The door handle, door hinges and the locking counterpart must be cleaned at least once a year (chap. 23.1).

## 24.3 Maintenance intervals, service

 	 <b>DANGER</b>
<p><b>Electrical hazard during live maintenance work.</b>  <b>Deadly electric shock.</b></p> <ul style="list-style-type: none"> <li>⊘ The chamber must NOT become wet during operation or maintenance works.</li> <li>⊘ Do NOT remove the rear panel of the chamber and the maintenance flaps on the chamber sides.</li> <li>➤ Before conducting maintenance work, turn off the chamber at the main power switch and disconnect the power plug.</li> <li>➤ General maintenance work must be conducted by licensed electricians or experts authorized by the manufacturer.</li> <li>➤ Maintenance work at the refrigeration system must only be conducted by qualified personnel who underwent training in accordance with EN 13313:2010 (e.g. a refrigeration technician with certified expert knowledge acc. to regulation 303/2008/EC). Follow the national statutory regulations.</li> </ul>	

Ensure regular maintenance work is performed at least once a year and that the legal requirements are met regarding the qualifications of service personnel, scope of testing and documentation. All work on the refrigeration system (repairs, inspections) must be documented.

	<p>The warranty becomes void if maintenance work is conducted by non-authorized personnel.</p>
--	--

With an increased amount of dust in the ambient air, clean the condenser fan (by suction or blowing) several times a year. Check the condenser air filter frequently and clean / replace it if necessary (chap. 24.2.1).

## 24.4 Service Reminder

You can display the time until the service due in the controller. Keep the **OK button** pressed down for 5 seconds.



The remaining time in days until maintenance is due is shown in the text field of the controller display.  
 Press the **OK button** to confirm the message.

After the recommended maintenance interval (one year of operation) a message appears on the controller.

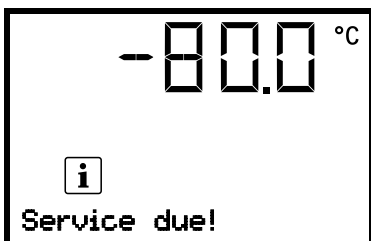

The message "Service due!" is shown in the text field of the controller display.  
 Press the **OK button** to confirm the message.

After one week of operation, the message reappears.

After performing the service, you can reset the service reminder:



Press the **OK button** for 20 seconds to reset the message for one year.

The message "Counter has been reset" is shown in the text field of the controller display.

Press the **OK button** to confirm the message.

## 24.5 Simple troubleshooting

Defects and shortcomings can compromise the operational safety of the chamber and can lead to risks and damage to equipment and persons. If there is a technical fault or shortcoming, take the chamber out of operation and inform the manufacturer's Service. If you are not sure whether there is a technical fault, proceed according to the following list. If you cannot clearly identify an error or there is a technical fault, please contact the Service.



Only qualified service personnel authorized by the manufacturer must perform repair. Repaired chambers must comply with the manufacturer's quality standards.

Fault description	Possible cause	Required measures
<b>General</b>		
Chamber without function.	No power supply.	Check connection to power supply.
	Wrong voltage.	Check power supply for correct voltage (chap.4.5).
	Chamber fuse has responded.	Check chamber fuse and replace it if appropriate. If it responds again, contact the Service.
	Controller defective.	Contact the Service.
Alarm message "Door open"	Chamber door open.	Close chamber door.
<b>Refrigerating performance</b>		
No refrigerating performance after turning on the chamber. Alarm message "Safety controller"	Limit temperature reached.	Check setting of temperature set-point and of safety controller. If appropriate, select suitable limit value.
	Too much external heat load.	Reduce heat load
	Controller defective.	Contact the Service.
	Safety controller defective.	
	Semi-conductor relay defective.	

Fault description	Possible cause	Required measures
<b>Refrigerating performance</b> (continued)		
Chamber refrigerating permanently, set-point not held.	Controller not adjusted, or adjustment interval exceeded.	Calibrate and adjust controller.
	Door not shut tightly.	Check if doors are closed.
	Frost on door gasket.	Defrost the door gasket with the ice scraper.
	Door opened very frequently.	Open doors less frequently
	Introduction of too warm or too large amount of material.	Cool down material before introducing and / or load in smaller portions.
	Place of installation too warm.	Select cooler place of installation or contact the Service.
	Door gasket defective.	Contact the Service.
	Semiconductor relay defective.	
Alarm message "Temp. range"	Current actual temperature value outside the tolerance range.	Operation temporarily possible. Check the tolerance range settings. With other error messages remove the respective cause.
Alarm message "Inner temp. sensor"	Inner temperature sensor defective. Control continues using the safety controller temperature sensor	Operation temporarily possible. Contact the Service.
Alarm message "Safety control sensor"	Safety controller temperature sensor defective	Operation temporarily possible. Contact the Service.
Temperature display shows "- - - -" or "<-<-<" or ">->->" Messages alternating: "Inner temp. sensor" and "Safety control sensor"	Inner temperature sensor and safety controller temperature sensor defective. Refrigeration is turned on permanently.	Contact the Service.
Alarm message "Cascade temp. sensor".	Failure of Pt100 temperature sensor. Refrigerating machine in continuous operation (see chap. 14.4.6).	Contact the Service.
Alarm message "Condensate temp. sensor" or "Ambient temp. sensor"	Failure of Pt100 temperature sensor.	Contact the Service.
No or too low refrigerating performance.	Temperature set-point not set correctly on the controller.	Set temperature set-point correctly.
	Ambient temperature too high > 32 °C (chap. 3.4).	Select cooler place of installation.
	Too much external heat load.	Reduce heat load.
	Pt 100 sensor defective.	Contact the Service.
	Refrigerating system defective.	
	Semiconductor relay defective.	
	Compressor not switched on.	
No or not enough refrigerant.		
Alarm message "Continuous operation"	Cooling system error.	Contact the Service.
	Semiconductor relay defective.	
	Controller defective.	
Alarm message "Compressor defective"	Cooling system error.	Turn off the chamber and contact the Service.
	Condenser fan defective.	

Fault description	Possible cause	Required measures
<b>Refrigerating performance</b> (continued)		
Alarm message "Condenser temp."	Condenser air filter soiled.	Clean / replace the condenser air filter (chap. 24.2.1).
	Condenser soiled.	Clean the condenser (chap. 24.2.2).
	Ventilation slots are blocked.	Make sure to have free air access to the chamber at the front and bottom.
	Chamber positioned too close to the wall (spacers not mounted or twisted).	Install / check the spacers (chap. 4.2).
	Place of installation too hot.	Select cooler place of installation or contact the Service.
<b>Humidity</b>		
Icing at the walls of the inner chamber	Long time of continuous operation.	Defrost the chamber (chap. 24.2.3)
<b>Controller</b>		
No chamber function (dark display).	Power failure. Display mode "Standby" active.	Press any key on the controller display.
	Main power switch (4) is off.	Turn on the main power switch (4).
Menu functions not available.	Menu functions not available with current authorization level.	Log in with the required higher authorization.
No access to controller	Password incorrect.	Contact the Service.
Acknowledging the alarm does not cancel the alarm state.	Cause of alarm persists.	Remove cause of alarm. If the alarm state continues, contact the Service.

## 24.6 Sending the chamber back

Chambers may be returned to LIEBHERR (for repair or for other reasons) only after clarification and confirmation with the responsible service representative of the respective country.

The contact details are contained in the LIEBHERR service brochure (included with every chamber) or can be called up online at [home.liebher.com/service](http://home.liebher.com/service).

Before any return, the completed contamination clearance certificate (chap. 28) is required.



## 25. Disposal

### 25.1 Disposal of the transport packing

Packing element	Material	Disposal
Straps to fix packing on pallet	Plastic	Plastic recycling
Wooden transport box (option) with metal screws	Non-wood (compressed match-wood, IPPC standard)	Wood recycling
	Metal	Metal recycling
Pallet with foamed plastic stuffing	Solid wood (IPPC standard)	Wood recycling
	PE foam	Plastic recycling
Transport box with metal clamps	Cardboard	Paper recycling
	Metal	Metal recycling
Top cover with foamed plastic stuffing	Cardboard	Paper recycling
	PE foam	Plastic recycling
Bag for operating manual	PE foil	Plastic recycling
Insulating air cushion foil (packing of optional accessories)	PE foil	Plastic recycling

If recycling is not possible, all packing parts can also be disposed of with normal waste.

### 25.2 Decommissioning

- Turn off the chamber with the main power switch (4) and disconnect it from the power supply (pull the power plug).
- Let the chamber defrost (chap. 24.2.3).
- Temporal decommissioning: See indications for appropriate storage, chap. 3.3.
- Final decommissioning: Dispose of the chamber as described in chap. 25.3 / 25.4.

When restarting the chamber, please pay attention to the corresponding information in chap. 6.2.

### 25.3 Disposal of the chamber in the member states of the EU

According to Annex I of Directive 2012/19/EU of the European Parliament and of the Council on waste electrical and electronic equipment (WEEE), the chambers are classified as “monitoring and control instruments” (category 9) only intended for professional use”. They must not be disposed of at public collecting points.

The chambers and the rechargeable battery bear the symbol for the marking of electrical and electronic equipment manufactured / placed on the market in the EC after 13 August 2005 and be disposed of in separate collection according to the Directive 2012/19/EU on waste electrical and electronic equipment (WEEE). WEEE marking: crossed-out wheeled bin with solid bar under.

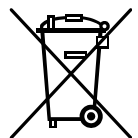





Used batteries contain substances that can be harmful to the environment and human health. These include cadmium (Cd), mercury (Hg) and lead (Pb). These substances are listed below the crossed-out wheeled bin symbol.

At the end of the chamber’s service life, have it disposed of in accordance with Directive 2012/19 / EU and national regulations or notify the distributor who sold you the chamber, who will take back and dispose of the chamber according to the Directive 2012/19/EU and national regulations.

	NOTICE
	<p><b>Danger of violation against existing law if not disposed of properly.</b>  <b>Failure to comply with applicable law.</b></p> <ul style="list-style-type: none"> <li>Ø Do NOT dispose of the chambers at public collecting points.</li> <li>➤ Have the chamber disposed of professionally at a recycling company that is certified according to conversion of the Directive 2012/19/EU into national law. <i>or</i></li> <li>➤ Instruct the distributor who sold you the chamber to dispose of it. The agreements apply that were agreed with the distributor when purchasing the chamber (e.g. his general terms of payment and delivery).</li> <li>➤ If your distributor is not able to take back and dispose of the chamber, please contact the manufacturer's service.</li> </ul>

Certified companies disassemble waste (used) equipment in primary substances for recycling according to Directive 2012/19/EU. The chambers must be free from toxic, infectious or radioactive substances in order to eliminate any health hazards to the employees of the recycling companies.



	<p>Prior to handing the chamber over to a recycling company, it is the user's responsibility that it is free from toxic, infectious or radioactive substances.</p> <ul style="list-style-type: none"> <li>• Prior to disposal, clean all introduced or residual toxic substances from the chamber.</li> <li>• Prior to disposal, disinfect the chamber from all sources of infection. Be aware that sources of infection may also be located outside the inner chamber.</li> <li>• If you cannot safely remove all toxic substances and sources of infection from the chamber, dispose of it as special waste according to national law.</li> <li>• Fill out the contamination clearance certificate (chap. 28) and enclose it with the chamber.</li> </ul>
---	---

 	 <b>WARNING</b>
	<p><b>Danger of intoxication and infection through contamination of the chamber with toxic, infectious or radioactive substances.</b>  <b>Damages to health.</b></p> <ul style="list-style-type: none"> <li>Ø NEVER take a chamber contaminated with toxic substances or sources of infection for recycling according to Directive 2012/19/EU.</li> <li>➤ Prior to disposal, remove all toxic substances and sources of infection from the chamber.</li> <li>➤ A chamber from which all toxic substances or sources of infection cannot be safely removed must be considered as "special" waste according to national law. Dispose of it accordingly.</li> </ul>

The disposal of batteries within the EU must be carried out in accordance with the current EU directives as well as national, regional and local environmental protection regulations.

The refrigerants used R290 (propane, GWP 3) and R170 (ethane, GWP 6) are inflammable at ambient pressure. A suction is not required. Ensure the compliance with the applicable legal requirements regarding qualification of staff, and documentation.

## 25.4 Disposal of the chamber in non-member states of the EU

 	<b>NOTICE</b>
	<p><b>Danger of violation against existing law if not disposed of properly.</b> <b>Failure to comply with applicable law. Alteration of the environment.</b></p> <ul style="list-style-type: none"><li>➤ For final decommissioning and disposal of the chamber, please contact the manufacturer's Service.</li><li>➤ Follow the statutory regulations for appropriate, environmentally friendly disposal.</li></ul>

The chamber is equipped with a rechargeable battery (12 V, 7.2 Ah) which can be recycled. Used batteries must be disposed of properly. Please ensure that you dispose of the battery in accordance with the regulations in force in your country.

The refrigerants used R290 (propane, GWP 3) and R170 (ethane, GWP 6) are inflammable at ambient pressure. A suction is not required. Ensure the compliance with the applicable legal requirements regarding qualification of staff, and documentation.

## 26. Technical description

### 26.1 Factory calibration and adjustment

The chambers were calibrated and adjusted in factory. Calibration and adjustment were performed using standardized test instructions, according to the QM DIN EN ISO 9001 system applied by the manufacturer. All test equipment used is subject to the administration of measurement and test equipment that is also a constituent part of the manufacturer's QM DIN EN ISO 9001 system. They are controlled and calibrated according to regulations at regular intervals.

	Repeated calibrations are recommended in periods of 12 months.
---	--

### 26.2 Over current protection

The chambers are equipped with an internal fuse not accessible from outside. If this fuse is blown, please inform an electronic engineer or the manufacturer's service.

## 26.3 Technical data

Chamber size		SUFsg 3501	SUFsg 5001	SUFsg 7001
<b>Exterior dimensions</b>				
Width, gross (including hinges, door lock and controller housing)	mm / inch	802 / 31.58	920 / 36.2	1204 / 47.4
Height, gross (incl. castors)	mm / inch	1966 / 77.4	1966 / 77.4	1966 / 77.4
Depth, gross (including power connection, without door lock and controller housing (equals depth when door open))	mm / inch	850 / 33.5	850 / 33.5	850 / 33.5
Depth, gross (including power connection, door lock and controller housing)	mm / inch	1005 / 39.6	1005 / 39.6	1005 / 39.6
Wall clearance rear (minimum)	mm / inch	100 / 3.9	100 / 3.9	100 / 3.9
Wall clearance side (side without hinges) (minimum)	mm / inch	100 / 3.9	100 / 3.9	100 / 3.9
Wall clearance side (side with hinges) (minimum)	mm / inch	250 / 9.84	245 / 9.6	245 / 9.6
<b>Doors</b>				
Number of chamber doors		1	1	1
Number of compartment doors		2	2	2
<b>Interior dimensions</b>				
Quantity of compartments		2	2	2
Width of inner chamber	mm / inch	486 / 19.13	606 / 23.9	890 / 35.0
Height of interior	mm / inch	1300 / 51.2	1300 / 51.2	1300 / 51.2
Height of individual compartment (with shelves)	mm / inch	312-319 12.3-12.6	312-319 12.3-12.6	312-319 12.3-12.6
Depth of inner chamber	mm / inch	636 / 25.04	636 / 25.04	636 / 25.04
Interior volume, total	l	402 / 14.2	501 / 17.7	736 / 26.0
<b>Shelves</b>				
Quantity of shelves (regular / max.)		3 / 11	3 / 11	3 / 11
Width of shelf	mm / inch	458 / 18.03	580 / 22.8	860 / 33.9
Depth of shelf	mm / inch	590 / 23.2	590 / 23.2	590 / 23.2
Permitted max. load per shelf (regular shelf)	kg / lbs	40 / 88	50 / 110	50 / 110
Permitted max. load of inner chamber bottom	kg / lbs	40 / 88	50 / 110	50 / 110
Permitted total load	kg / lbs	160 / 353	200 / 441	200 / 441
<b>Temperature data</b>				
Setting and control range	°C °F	-40 up to -90 -40 up to -130	-40 up to -90 -40 up to -130	-40 up to -90 -40 up to -130
Temperature uniformity (variation) at -80 °C / -112 °F	± K	3.5	2.5	2.5
Temperature fluctuation at -80 °C / -112 °F	± K	4.0	1.5	1.5
Pull-down time from +25 °C / 71.6 °F to -80 °C / -112 °F	minutes	180	360	450
Pull-up time in case of power failure from -80 °C / -112 °F to -60 °C / -76 °F	minutes	170	230	250
Pull-up time in case of power failure from -80 °C / -112 °F to 0 °C / -32 °F	minutes	1170	2160	2220

Chamber size		SUFsg 3501	SUFsg 5001	SUFsg 7001
<b>Weight</b>				
Weight of the chamber (empty)	kg / lbs	230 / 507	259 / 571	301 / 664
<b>Electrical Data SUFsg 3501,001 / SUFsg 5001,001 / SUFsg 7001,001/ SUFsg 5001,H72 / SUFsg 7001,H72 (230 V)</b>				
IP system of protection acc. to EN 60529	IP	20	20	20
Nominal voltage ( $\pm 10\%$ ) at 50 Hz power frequency	V	230	230	230
Current type		1N~	1N~	1N~
Nominal power	kW	1.6	1.6	1.6
Nominal current	A	7.0	7.0	7.0
Nominal current, chamber with water cooling	A	--	8.8	8.8
IEC connector plug and cable	mm / inch	3000 / 118.1	3000 / 118.1	3000 / 118.1
Power plug		Grounded plug		
Installation category acc. to IEC 61010-1		II	II	II
Pollution degree acc. to IEC 61010-1		2	2	2
Internal over-current release category C, 2 poles	A	10	10	10
<b>Electrical Data SUFsg 3501,137 / SUFsg 5001,137 / SUFsg 7001,137 (115 V)</b>				
IP system of protection acc. to EN 60529	IP	20	20	20
Nominal voltage (+/- 10%) at 60 Hz power frequency	V	115	115	115
Current type		1N~	1N~	1N~
Nominal power	kW	1.4	1.4	1.4
Nominal current	A	11.7	11.7	11.7
IEC connector plug and cable	mm / inch	3000 / 118.1	3000 / 118.1	3000 / 118.1
Power plug	NEMA	5-15P	5-15 P	5-15 P
Installation category acc. to IEC 61010-1		II	II	II
Pollution degree acc. to IEC 61010-1		2	2	2
Internal over-current release category C, 2 poles	A	15	15	15
<b>Electrical Data SUFsg 5001,123 / SUFsg 7001,123 (208-230 V)</b>				
IP system of protection acc. to EN 60529	IP	--	20	20
Nominal voltage (+/- 10%) at 60 Hz power frequency	V	--	208 - 230	208 - 230
Current type		--	2~	2~
Nominal power	kW	--	1.8	1.8
Nominal current	A	--	8.2	8.2
IEC connector plug and cable	mm / inch	--	3000 / 118.1	3000 / 118.1
Power plug	NEMA	--	6-15P	6-15P
Installation category acc. to IEC 61010-1		--	II	II
Pollution degree acc. to IEC 61010-1		--	2	2
Internal over-current release category C, 2 poles	A	--	10	10

Chamber size		SUFsg 3501	SUFsg 5001	SUFsg 7001
<b>Environment-specific data SUFsg 3501,001 / SUFsg 5001,001 / SUFsg 7001,001/ SUFsg 5001,H72 / SUFsg 7001,H72 (230 V)</b>				
Noise level (mean value)	dB (A)	47	47	47
Energy consumption at set point -80 °C/ -112 °F, with an ambient temperature of +20 °C / 68°F	kWh/day	7.5	7,9	8,1
Average heat dissipation at set-point -80 °C / -112 °F, with an ambient temperature of +20 °C / 68 °F	W	310	330	340
Filling weight of refrigerant R290 (propane) (1 <sup>st</sup> stage cooling, GWP 3)	kg	0.15	0.15	0.15
Filling weight of refrigerant R170 (ethane) (2 <sup>nd</sup> stage cooling, GWP 6)	kg	0.145	0.15	0.15
Chamber with water cooling: Filling weight of refrigerant R290 (propane) (1 <sup>st</sup> stage cooling, GWP 3)	kg	---	0.15	0.15
Chamber with water cooling: Filling weight of refrigerant R170 (ethane) (2 <sup>nd</sup> stage cooling, GWP 6)	kg	---	0.15	0.15
<b>Environment-specific data SUFsg 3501,137 / SUFsg 5001,137 / SUFsg 7001,137 (115 V)</b>				
Noise level (mean value)	dB (A)	47	47	47
Energy consumption at set point -80 °C/ -112 °F, with an ambient temperature of +20 °C / 68°F	kWh/day	7.5	7.9	8.1
Average heat dissipation at set-point -80 °C / -112 °F, with an ambient temperature of +20 °C / 68 °F	W	310	330	340
Filling weight of refrigerant R290 (propane) (1 <sup>st</sup> stage cooling, GWP 3)	kg	0.15	0.15	0.15
Filling weight of refrigerant R170 (ethane) (2 <sup>nd</sup> stage cooling, GWP 6)	kg	0.145	0.15	0.15
<b>Environment-specific data SUFsg 5001,123 / SUFsg 7001,123 (208-230 V)</b>				
Noise level (mean value)	dB (A)	--	47	47
Energy consumption at set-point -80 °C/ -112 °F, with an ambient temperature of +20 °C / 68°F	kWh/day	--	7.9	8.1
Average heat release at set-point -80 °C/ -112 °F, with an ambient temperature of +20 °C / 68 °F	W	--	330	330
Filling weight of refrigerant R290 (propane) (1 <sup>st</sup> stage cooling, GWP 3)	kg	--	0.15	0.15
Filling weight of refrigerant R170 (ethane) (2 <sup>nd</sup> stage cooling, GWP 6)	kg	--	0.15	0.15

All technical data is specified for chambers with unloaded standard equipment at an ambient temperature of +22 °C +/- 3°C / 71.6 °F +/- 5.4 °F and a power supply voltage fluctuation of +/-10. Specification of the sound pressure level +/- 1 dB(A). Technical data is determined in accordance to standardized internal guidelines and DIN 12880:2007.

**All indications are average values, typical for chambers produced in series. We reserve the right to change technical specifications at any time.**

## 26.4 Equipment and options, accessories and spare parts (extract)



To operate the chamber, use only original accessories from the manufacturer or accessories / components from third-party suppliers authorized by the manufacturer. The user is responsible for any risk arising from using unauthorized accessories.



The manufacturer is responsible for the safety features of the chamber only provided skilled electricians or qualified personnel authorized by the manufacturer perform all maintenance and repair, and if components relating to chamber safety are replaced in the event of failure with original spare parts.

<b>Regular equipment</b>
Microprocessor chamber controller for temperature
Electronic error auto-diagnosis system with zero-voltage relay alarm output
Ethernet interface for computer communication
USB interface
Safety controller
VIP technology (Vacuum Insulation Panels)
Powerful, energy-efficient refrigeration system
Four compartments, two compartment doors
Three shelves
Three 28 mm access ports
Connection kit for cooling water (chambers with water cooling)
Battery-buffered alarm system
Voltage 230 V, 50 Hz
Voltage 115 V, 60 Hz or 208-230 V, 60 Hz

<b>Options / accessories</b>
Stainless steel shelf set, 1 shelf with shelf holders
Side access rack, stainless steel or aluminum, empty or with cryo boxes
Sliding drawer rack, stainless steel or aluminum, empty or with cryo boxes
Cryo boxes with dividers, set of 39 pc.
Lockable protective flap for the main power switch
Connection kit for cooling water (chambers with water cooling)
CO <sub>2</sub> emergency cooling
Analog output 4-20 mAmp for temperature with 6 pole socket, plug included

<b>Spare parts</b>
Outer chamber door gasket, silicon
Inner chamber door gasket, silicon
Compartment door, regular
Compartment door with gasket, foamed (option)
Standard shelf for compartment
Rechargeable battery 12V, 7.2 Ah
Replacement condenser air filter
Fuse 4A / 250V - F - 6,3x32mm
Over-current release category C 10 A (for 230 V and 208-230 V chambers)
IEC connector plug for EU with 3 m cable
IEC connector plug for Switzerland with 3 m cable
IEC connector plug for UK with 3 m cable
Spacers
Insulated compartment doors SUFsg 5001
Insulated compartment doors SUFsg 7001
Front castor with lock
Rear castor
CO <sub>2</sub> emergency cooling, retrofit kit, installation by Service of the authorized dealer. Adjustable between -40 °C / -40 °F and -70 °C / -94 °F



## 26.5 Dimensions SUFsg 3501

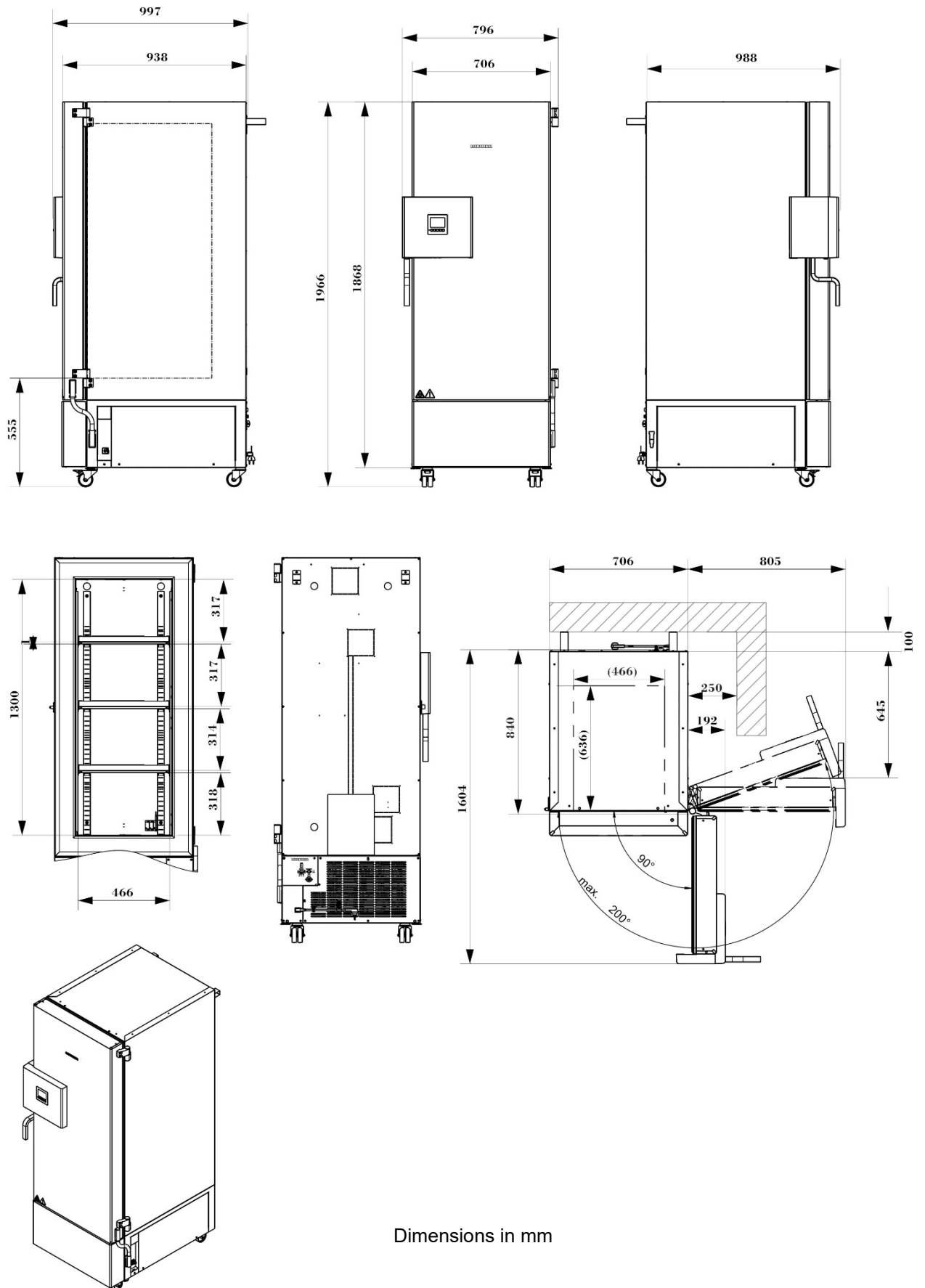

## 26.6 Dimensions SUFsg 5001

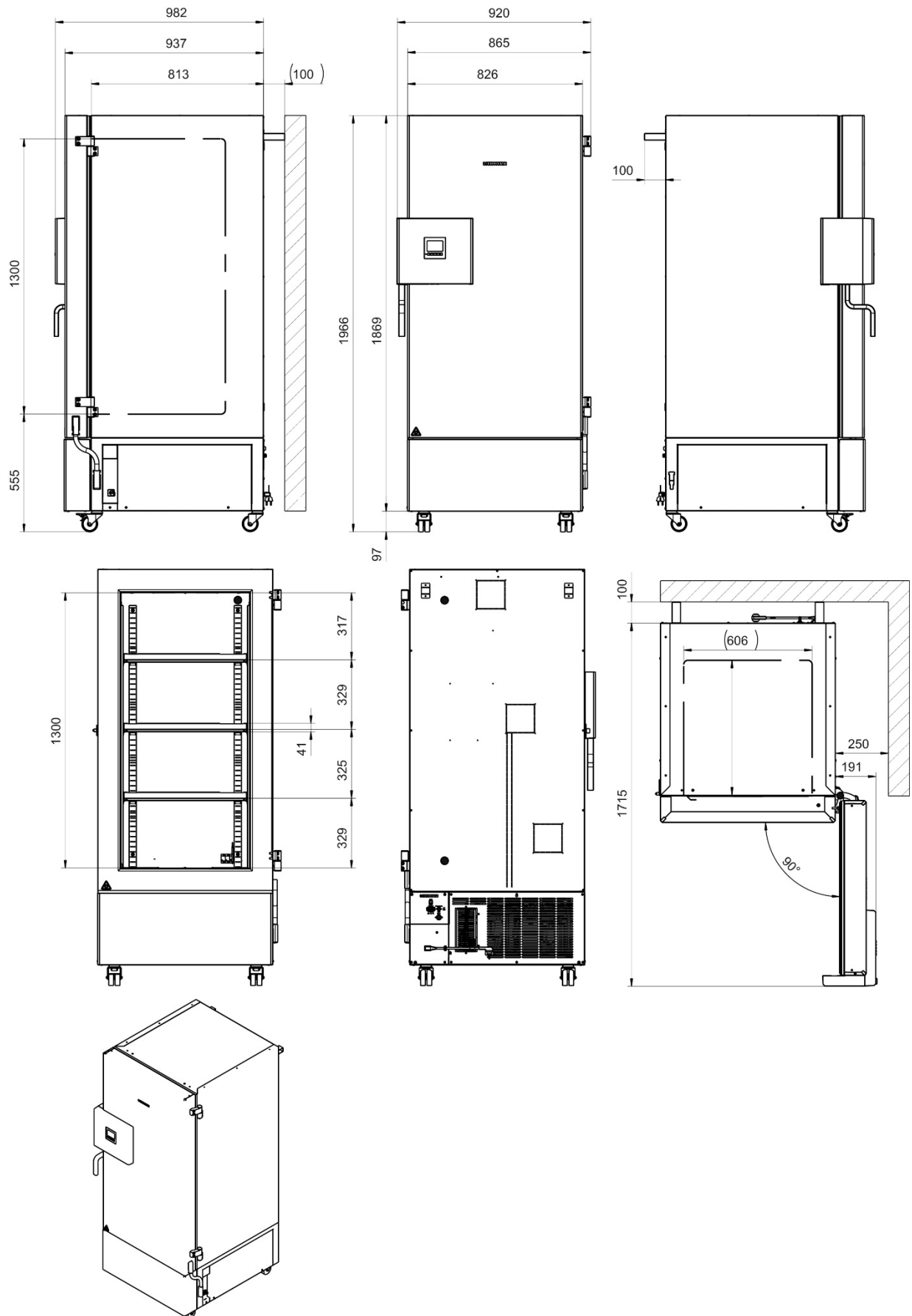

Dimensions in mm

## 26.7 Dimensions SUFsg 7001

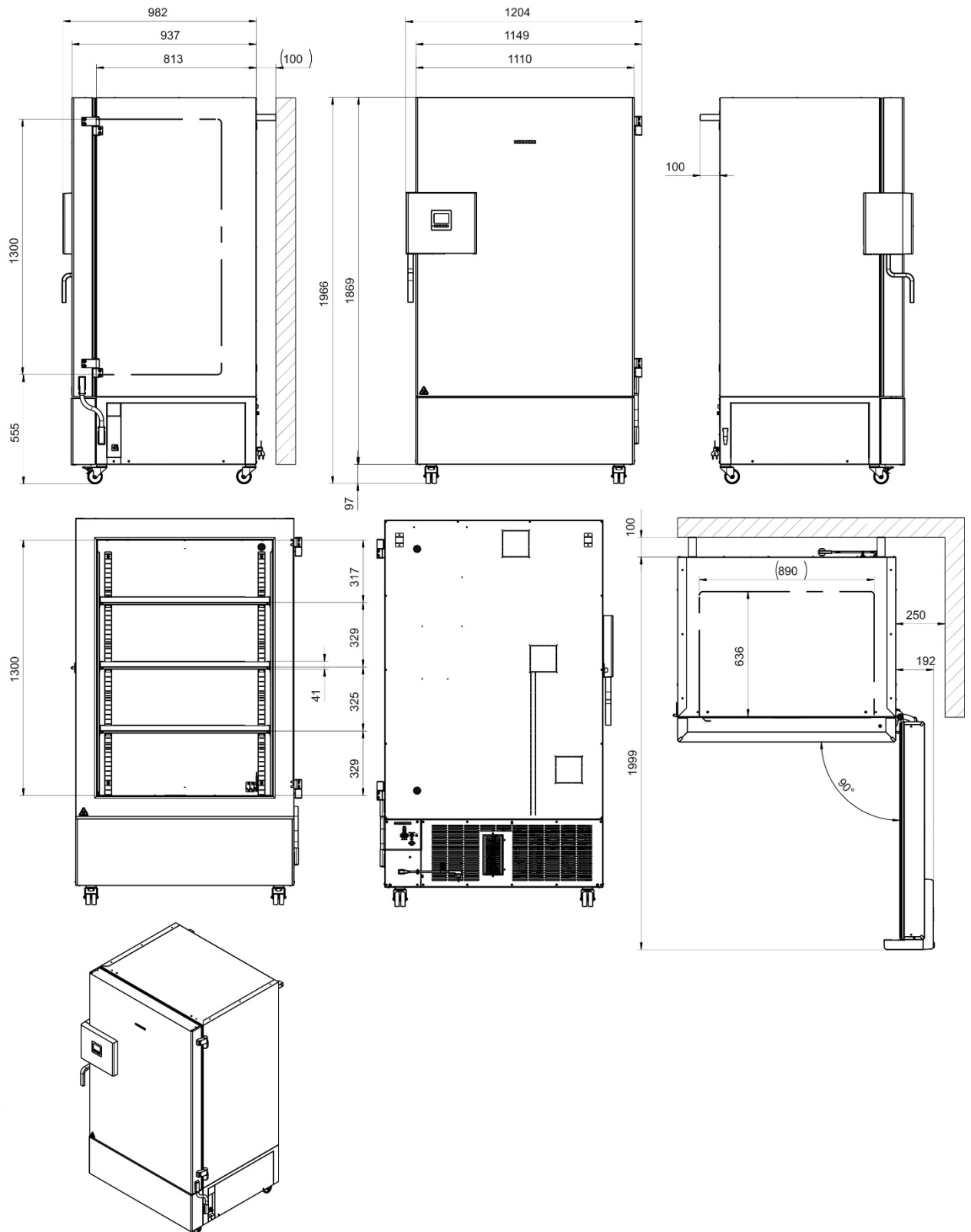

Dimensions in mm

## 27. EU Declaration of Conformity

The refrigerant circuit has been checked for leaks.

The chamber complies with the relevant safety regulations as well as the EU Directives 2014/35/EU, 2014/30/EU, and 2011/65/EU.

The full text of the EU Declaration of Conformity is available at the following internet address:  
[www.liebherr.com](http://www.liebherr.com)

## 28. Contamination clearance certificate

### Declaration regarding safety and health

Erklärung zur Sicherheit and gesundheitlichen Unbedenklichkeit

The German Ordinance on Hazardous Substances (GefStofV), and the regulations regarding safety at the workplace, require that this form be filled out for all products that are returned to us, so that the safety and the health of our employees can be guaranteed.

Die Sicherheit und Gesundheit unserer Mitarbeiter, die Gefahrstoffverordnung GefStofV und die Vorschriften zur Sicherheit am Arbeitsplatz machen es erforderlich, dass dieses Formblatt für alle Produkte, die an uns zurückgeschickt werden, ausgefüllt wird.



Note: A repair is not possible without a completely filled out form.  
Ohne Vorliegen des vollständig ausgefüllten Formblattes ist eine Reparatur nicht möglich.

- A completely filled out form must be transmitted must be communicated to the responsible LIEBHERR service agency in advance in advance, so that this information is available before the equipment/component part arrives. A second copy of this form must accompany the equipment/component part. In addition, the carrier should be notified.

Eine vollständig ausgefüllte Kopie dieses Formblattes soll per Fax unter Nr. +49 (0) 7462 2005 93555 oder Brief vorab an uns gesandt werden, so dass die Information vorliegt, bevor das Gerät/Bauteil eintrifft. Eine weitere Kopie soll dem Gerät/Bauteil beigefügt sein. Ggf. ist die Spedition zu informieren.

- Incomplete information or non-conformity with this procedure will inevitably lead to substantial delays in processing. Please understand the reason for this measure, which lies outside our area of influence, and help us to speed up this procedure.

Unvollständige Angaben oder Nichteinhalten dieses Ablaufs führen zwangsläufig zu beträchtlichen Verzögerungen in der Abwicklung. Bitte haben Sie Verständnis für Maßnahmen, die außerhalb unserer Einflussmöglichkeiten liegen und helfen Sie mit, den Ablauf zu beschleunigen.

- You can find information on data protection at <https://www.liebherr.com/privacydocs/LWL/LWL-DSE-Geschäftspartner.pdf>

Hinweise zum Datenschutz finden Sie unter dem angegebenen Link.

- **Please fill out this form completely.**

Bitte unbedingt vollständig ausfüllen!

<b>1.</b>	<b>Unit/ component part / type</b> / Gerät / Bauteil / Typ:
<b>2.</b>	<b>Serial No.</b> / Serien-Nr.:
<b>3.</b>	<b>Details about utilized substances / biological substances</b> / Einzelheiten über die eingesetzten Substanzen/biologische Materialien:
<b>3.1</b>	<b>Designations</b> / Bezeichnungen:
a)	_____
b)	_____
c)	_____
<b>3.2</b>	<b>Safety measures required for handling these substances</b> / Vorsichtsmaßnahmen beim Umgang mit diesen Stoffen:
a)	_____
b)	_____
c)	_____

<b>3.3</b>	<b>Measures to be taken in case of skin contact or release into the atmosphere</b> / Maßnahmen bei Personenkontakt oder Freisetzung:
a)	_____
b)	_____
c)	_____
d)	_____
<b>3.4</b>	<b>Other important information that must be taken into account</b> / Weitere zu beachtende und wichtige Informationen:
a)	_____
b)	_____
c)	_____
<b>4.</b>	<b>Declaration on the risk of these substances</b> (please checkmark the applicable items) / Erklärung zur Gefährlichkeit der Stoffe (bitte Zutreffendes ankreuzen) :
<input type="checkbox"/>	<b>4.1 For non toxic, non radioactive, biologically harmless materials</b> / für nicht giftige, nicht radioaktive, biologisch ungefährliche Stoffe: <b>We hereby guarantee that the above-mentioned unit / component part...</b> / Wir versichern, dass o.g. Gerät/Bauteil...
<input type="checkbox"/>	Has not been exposed to or contains any toxic or otherwise hazardous substances / weder giftige noch sonstige gefährliche Stoffe enthält oder solche anhaften.
<input type="checkbox"/>	That eventually generated reaction products are non-toxic and also do not represent a hazard / auch evtl. entstandene Reaktionsprodukte weder giftig sind noch sonst eine Gefährdung darstellen.
<input type="checkbox"/>	Eventual residues of hazardous substances have been removed / evtl. Rückstände von Gefahrstoffen entfernt wurden.
<input type="checkbox"/>	<b>4.2 For toxic, radioactive, biologically harmful or hazardous substances, or any other hazardous materials</b> / für giftige, radioaktive, biologisch bedenkliche bzw. gefährliche Stoffe oder anderweitig gefährliche Stoffe. <b>We hereby guarantee that ...</b> / Wir versichern, dass ...
<input type="checkbox"/>	The hazardous substances, which have come into contact with the above-mentioned equipment / component part, have been completely listed under item 3.1 and that all information in this regard is complete / die gefährlichen Stoffe, die mit dem o.g. Gerät/Bauteil in Kontakt kamen, in 3.1 aufgelistet sind und alle Angaben vollständig sind.
<input type="checkbox"/>	That the unit /component part has not been in contact with radioactivity / das Gerät/Bauteil nicht mit Radioaktivität in Berührung kam
<b>5.</b>	<b>Kind of transport / transporter</b> / Transportweg/Spediteur:  Transport by (means and name of transport company, etc.) / Versendung durch (Name Spediteur o.ä.) _____  Date of dispatch to the manufacturer / Tag der Absendung an den Hersteller: _____

**We hereby declare that the following measures have been taken / Wir erklären, dass folgende Maßnahmen getroffen wurden:**

- Hazardous substances were removed from the unit including component parts, so that no hazard exists for any person in the handling or repair of these items / das Gerät/Bauteil wurde von Gefahrstoffen befreit, so dass bei Handhabung/Reparaturen für die betreffende Person keinerlei Gefährdung besteht
- The unit was securely packaged and properly identified / das Gerät wurde sicher verpackt und vollständig gekennzeichnet.
- Information about the hazardousness of the shipment (if required) has been provided to the transporter / der Spediteur wurde (falls vorgeschrieben) über die Gefährlichkeit der Sendung informiert.

We hereby commit ourselves and guarantee that we will indemnify the manufacturer for all damages that are a consequence of incomplete or incorrect information provided by us, and that we will exempt the manufacturer from eventual damage claims by third parties. / Wir versichern, dass wir gegenüber dem Hersteller für jeden Schaden, der durch unvollständige und unrichtige Angaben entsteht, haften und den Hersteller gegen eventuell entstehende Schadenansprüche Dritter freistellen.

We are aware that, in accordance with Article 823 of the German Civil Code (BGB), we are directly liable with regard to third parties, in this instance especially the employees of the manufacturer, who have been entrusted with the handling / repair of the unit / component. / Es ist uns bekannt, dass wir gegenüber Dritten – hier insbesondere mit der Handhabung/Reparatur des Geräts/des Bauteils betraute Mitarbeiter der Firma des Herstellers - gemäß §823 BGB direkt haften.

Name: \_\_\_\_\_

Title / Position: \_\_\_\_\_

Date / Datum: \_\_\_\_\_

Signature / Unterschrift: \_\_\_\_\_

Company stamp / Firmenstempel:



Equipment that is returned to the factory for repair must be accompanied by a completely filled out contamination clearance certificate. For service and maintenance on site, such a contamination clearance certificate must be submitted to the service technician before the start of any work. No repair or maintenance of the equipment is possible, without a properly filled out contamination clearance certificate.



**Liebherr-Hausgeräte GmbH**  
Memminger Straße 77-79  
88416 Ochsenhausen  
Germany  
[home.liebherr.com](http://home.liebherr.com)

