

---

# R 917 Compact Litronic

---

## LIEBHERR

Crawler excavator



**Generation**  
8

**Operating weight**  
16,280–18,430 kg

**Engine**  
100 kW / 136 HP  
Stage V

**Bucket capacity**  
0.32–0.95 m<sup>3</sup>

# Compact, versatile, connected R 917 Compact

---

## ① Maintenance

- Servicing concept, with service points accessible from ground level
- Engine oil level and filling nozzle accessible from ground level

## ② Equipment

- Large choice of types and sizes of equipment
- Longer lifespan of components and higher productivity thanks to automatic centralised lubrication system
- Safety check valves for hoist and stick cylinders
- Large choice of tools and teeth to suit all applications

## ③ Safety

- Panoramic visibility with no obstructions and camera on the rear and the right side equipment for enhanced safety
- Liftable console for easy and safe access to cab
- ROPS-certified cab structure: rollover protection
- Emergency exit via the rear cab window
- Right window and windshield in laminated and tinted glass

## ④ Undercarriage

- Robust, reliable X-frame undercarriage, easy to secure thanks to its integrated eyelets
- Easy maintenance
- Several levelling blades available
- Optional rubber track pads for urban application
- Possibility to anchor the machine with the blade
- Maintenance-free travel gear and track rollers with lifetime lubrication
- Extra storage as an option

## ⑤ Compactness

- Short tail swing radius of 1.70 m for increased safety and flexibility on work sites
- The perfect machine for narrow sites – ideal for urban applications and on motorways



## ⑥ Comfort

- Spacious, air-conditioned work space
- Airsprung seat with vertical and horizontal suspension
- Easy-to-use high resolution 10" colour touchscreen
- Completely retractable front cab window
- Groundbreaking, intuitive INTUSI human-machine interface

## ⑦ Engine

- New engine that conforms with the Stage V European exhaust emissions standard
- Automatic idle-stop

## ⑧ New technologies

- **Bucket Fill Assist (BFA)**  
Automatic bucket-filling cycle for increased productivity, as standard with 500 machine hours included
- **Modetronic**  
Customisable driving modes for optimised work cycles tailored to each type of application, as standard
- **Liebherr Connect**  
Latest-generation telemetry system, as standard
- **MyLiebherr**  
Series customer portal with numerous downloadable applications (subscription required)



# Versatility and performance on site

---

## A machine designed to do the job

Thanks to a perfectly balanced design and an extensive range of working attachments, Generation 8 Liebherr compact excavators can be used for a wide range of applications: earthmoving, road and utility services, municipal work, landscaping and light demolition. Their high degree of flexibility in terms of configuration ensures that each site can be optimised using a single machine.

Equipped with a wide range of booms, sticks and hydraulically operated attachments, they can be transformed into extremely versatile multi-purpose tool carriers. Result: optimised productivity and the ability for a single machine to replace several others on the site.



## Performance that meets modern-day requirements

Designed to meet the growing productivity demands of modern job sites, Liebherr compact excavators combine powerful engines with optimised hydraulic performance to deliver fast, smooth and efficient working cycles.

Thanks to smooth combined movements and outstanding digging, travel and swing performance, they deliver consistently high productivity throughout the working day.

## A response to the challenges of the compact market

When faced with increasingly complex job sites – greater urbanisation, restricted access and budgetary constraints – the compact excavators from Liebherr can handle any challenge with ease. Despite their compact size, they deliver high-level performance, perfectly suited to urban environments and confined spaces.

Designed to operate anywhere, even in the harshest conditions, they combine agility and power to maintain optimum efficiency. Result: rapid cycle times and optimised productivity on every site.



# Operational efficiency and maximum productivity

---



## Optimum dynamics for the job site

An excavator's effectiveness is measured by more than its specifications – it is defined by its ability to perform efficiently across a wide range of applications and job sites. Liebherr compact excavators are designed with an optimised working range that reduces the need for repositioning, helping operators work more efficiently.

Their reach and depth have been perfectly adapted to the challenges of the ground, facilitating loading operations while ensuring great precision. Result: fewer unnecessary movements, masterful execution and maximum productivity every day.

## A machine that performs well in all conditions

Designed to deliver a high level of performance in all conditions, Liebherr compact excavators adapt to all types of ground. Their traction ensure safe movement, even on inclined surfaces or difficult terrain.

The optimised rotational torque makes all loading operations easier, while the load-bearing capacities meet the demands of even the most challenging applications. Result: constant and reliable productivity on all job sites.



## Optimisation of the work cycles

The technologies incorporated in the Liebherr compact excavators make it possible to individually adapt the machine to user requirements and to optimise overall efficiency. The operating modes can be customised to tailor the performance for each application.

Energy optimisation plays a part in reducing fuel consumption for greater cost-effectiveness in day-to-day operations.

# Reliability, availability and cost control

---

## A design committed to sustainability

Designed for durability, Liebherr compact excavators tackle the challenges of even the most demanding sites. Their robust construction, together with components built to withstand heavy-duty use, guarantees outstanding reliability.

The blade has been engineered with an optimised profile and geometry to improve material clearance and grading performance. Manufactured from highly wear-resistant steel, it delivers exceptional durability while requiring virtually no maintenance. Proportional control via the mini-joystick or hand lever provides the precision needed for fine grading and accuracy-focused applications.



## Simple maintenance for maximum availability

Productivity also goes hand in hand with maximum availability of the machine. Liebherr compact excavators are designed for ease of maintenance, with simple access to all maintenance points from the ground.

Fast and efficient maintenance operations help reduce downtime and optimise the period of operation. Result: more productive hours, less downtime and greater profitability every day.

## Connectivity and intelligent machine management

Digital solutions from Liebherr can be used to manage and optimise the use of the machines in day-to-day operations. Thanks to the integrated telemetry, performance monitoring is simplified and all the data is accessible via a dedicated customer portal.

This transparency improves management of the fleet and helps optimise operating costs. Ready to integrate the support systems of the future, these machines perfectly embody a forward-looking approach.



# The new emCAB operator's cab

## The new operating system for a smarter job site

In today's construction industry, intuitive machine control is essential for maximising productivity and ease of use. INTUSI (Intuitive User Interface) integrates intelligent control logic with advanced machine learning capabilities, offering a highly customizable interface. This innovation significantly enhances operational efficiency and user comfort on the job site.



## Ultra-ergonomic control with Liebherr joysticks

Central to the INTUSI experience are two joysticks designed and developed by Liebherr to the highest quality standards, ergonomically positioned on either side of the operator's seat. Designed for comfort at work, they offer a completely natural and very comfortable grip and reduce operator fatigue – even during extended shifts.

## Intuitive operation thanks to uncluttered control units

A compact display to the right of the operator enables quick access to important functions. The optimised arrangement of the control elements on the right-hand console ensures intuitive operation and minimises fatigue. An operating system that adapts to your needs, not the other way around.



# Technical data



## Diesel engine

<b>Rating per ISO 9249</b>	100 kW (136 HP) at 1,800 RPM
<b>Torque</b>	550 Nm at 1,600 RPM
<b>Model</b>	Deutz TCD3.6L4
<b>Type</b>	4 cylinder in-line
<b>Bore / Stroke</b>	98 / 120 mm
<b>Displacement</b>	3,6 l
<b>Engine operation</b>	4-stroke diesel Common-Rail injection system Turbo-charged and after-cooler Reduced emissions
<b>Air cleaner</b>	Dry-type air cleaner with pre-cleaner, primary and safety elements
<b>Engine idling</b>	Sensor controlled
<b>Electrical system</b>	
<b>Voltage</b>	24 V
<b>Batteries</b>	2 x 145 Ah / 12 V
<b>Alternator</b>	Three-phase current 28 V / 140 A
<b>Stage V</b>	
<b>Harmful emissions values</b>	According to regulation (EU) 2016/1628
<b>Emission control</b>	Deutz DOC + DPF + SCR technology
<b>Fuel tank</b>	169 l
<b>Urea tank</b>	20 l



## Cooling system

<b>Diesel engine</b>	Water-cooled Compact cooling system comprising cooling unit for water, hydraulic oil and charge air with stepless, thermostatically controlled fan, retractable thermostatic fan for radiator cleaning
----------------------	---



## Hydraulic controls

<b>Power distribution</b>	Via control valves with integrated safety valves, simultaneous and independent actuation of undercarriage, swing drive and equipment
<b>Servo circuit</b>	Equipment and swing
<b>Travel</b>	Electro-proportional via foot pedal
<b>Additional functions</b>	Via switch or electro-proportional foot pedals
<b>Proportional control</b>	Proportionally acting transmitters on the joysticks for additional hydraulic functions



## Hydraulic system

<b>Hydraulic pump</b>	For equipment and travel drive	Liebherr axial piston variable displacement pump
<b>Max. flow</b>		300 l/min.
<b>Max. pressure</b>		350 bar
<b>Hydraulic pump regulation and control</b>		Liebherr-Synchron-Comfort-system (LSC) with electronic engine speed sensing regulation, pressure and flow compensation, torque controlled swing drive priority
<b>Hydraulic tank</b>		93.4 l
<b>Hydraulic system</b>		max. 230 l
<b>Filtration</b>		1 main return filter with integrated partial micro filtration (5 µm)
<b>MODE selection</b>		Adjustment of engine and hydraulic performance via a mode pre-selector to match application, e.g. for especially economical and environmentally friendly operation or for maximum digging performance and heavy-duty jobs
<b>S (Sensitive)</b>		Mode for precision work and lifting through very sensitive movements
<b>E (Eco)</b>		Mode for especially economical and environmentally friendly operation
<b>P (Power)</b>		Mode for high performance with low fuel consumption
<b>P+ (Power-Plus)</b>		Mode for highest performance and for very heavy duty applications, suitable for continuous operation
<b>Engine speed and performance setting</b>		Stepless adjustment of engine output and hydraulic power via engine speed
<b>Additional function</b>		Tool Control: 20 pre-adjustable pump flows and pressures for add-on attachments



## Swing drive

<b>Drive</b>	Liebherr axial piston motor with integrated brake valve and torque control
<b>Transmission</b>	Liebherr compact planetary reduction gears
<b>Swing ring</b>	Liebherr, sealed race ball bearing swing ring, internal teeth
<b>Swing speed</b>	0-10.0 RPM stepless
<b>Swing torque</b>	54 kNm
<b>Holding brake</b>	Wet multi-disc (spring applied, pressure released)
<b>Additional function</b>	Positioning swing brake automatic



## Cab

<b>Cab</b>	ROPS safety cab structure (roll-over protection system) with individual windscreens or featuring a slide-in subpart under the ceiling, headlights integrated in the ceiling, a door with a sliding window, large stowing and depositing possibilities, shock-absorbing suspension, sound damping insulating, laminated safety glass, separate window shades for the sunroof window and windscreen
<b>Operator's seat Comfort</b>	Air cushioned operator's seat with 3D-adjustable armrests, headrest, lap belt, seat heater (2-stage), adjustable seat cushion inclination and length, lockable horizontal suspension, automatic weight adjustment, pneumatic low frequency suspension, adjustable suspension stiffness, pneumatic lumbar vertebrae support and passive seat climatisation with active coal
<b>Operator's seat Premium (Option)</b>	In addition to operator's seat Comfort: active electronic weight adjustment (automatic readjustment) and active seat climatisation with active coal and ventilator
<b>Arm consoles</b>	Joysticks with control consoles attached to the seat, folding left control console
<b>Operation and displays</b>	Large high-resolution operating unit, intuitive, colour display with touchscreen, haptic feedback, video-compatible, numerous setting, control and monitoring options, e.g. air conditioning control, fuel consumption, machine and attachment parameters
<b>Air-conditioning</b>	Automatic air-conditioning, recirculated air function, fast de-icing and demisting at the press of a button, air vents can be operated via a menu; recirculated air and fresh air filters can be easily replaced and are accessible from the outside; heating-cooling unit, designed for extreme outside temperatures, sensors for solar radiation, inside and outside temperatures (country-dependent) The air conditioning system contains fluorinated greenhouse gases
Refrigerant	R134a
Global warming potential	1,430
Quantity at 25 °C*	1,300g
CO <sub>2</sub> equivalent	1.859t
<b>Vibration emission**</b>	
Hand / arm vibrations	< 2.5 m/s <sup>2</sup>
Whole-body vibrations	< 0.5 m/s <sup>2</sup>
Measuring inaccuracy	According with standard EN 12096:1997



## Undercarriage

<b>LC</b>	Gauge 2,000 mm
<b>Drive</b>	Liebherr axial piston motor
<b>Transmission</b>	Liebherr compact planetary reduction gear
<b>Maximum travel speed</b>	3.1 km/h low range 6.9 km/h high range
<b>Drawbar pull on crawler</b>	151 kN
<b>Track components</b>	B4, maintenance-free
<b>Track rollers / Carrier rollers</b>	7 / 2
<b>Tracks</b>	Sealed and greased
<b>Track pads</b>	Triple grouser
<b>Holding brake</b>	Wet multi-disc (spring applied, pressure released)
<b>Brake valves</b>	Integrated into travel motor
<b>Lashing eyes</b>	Integrated



## Equipment

<b>Type</b>	High-strength steel plates at highly-stressed points for the toughest requirements. Complex and stable mountings of equipment and cylinders
<b>Hydraulic cylinders</b>	Liebherr cylinders with seal and guidance systems
<b>Bearings</b>	Sealed, low maintenance



## Complete machine

<b>Lubrication</b>	Liebherr central lubrication system for uppercarriage and equipment
<b>Noise emission</b>	
ISO 6396	70 dB(A) = L <sub>pA</sub> (inside cab)
2000/14/EC	102 dB(A) = L <sub>WA</sub> (surround noise)

\* valid for standard machine without operator's cab elevation and without height adjustable cab

\*\* for the risk assessment according to 2002/44/EC see ISO/TR 25398:2006

# Dimensions

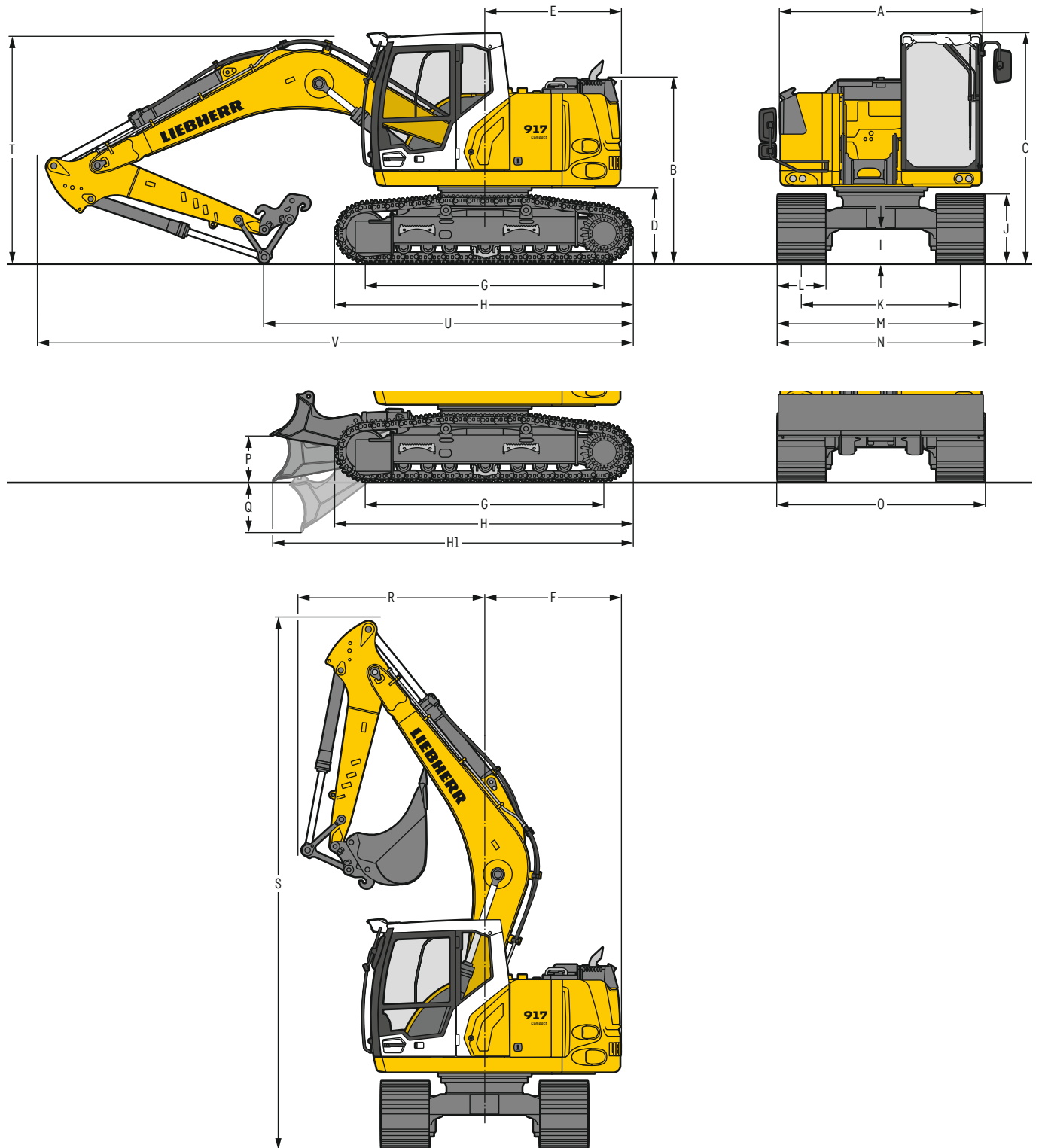

		LC				mm	LC with blade				mm
<b>A</b>	Uppercarriage width					2,525					2,525
<b>B</b>	Uppercarriage height					2,330					2,330
<b>C</b>	Cab height					2,895					2,895
<b>D</b>	Counterweight ground clearance					960					960
<b>E</b>	Rear-end length					1,700					1,700
<b>F</b>	Tail swing radius					1,700					1,700
<b>G</b>	Wheelbase					3,000					3,000
<b>H</b>	Undercarriage length					3,740					3,740
<b>H1</b>	Undercarriage length with blade					-					4,525
<b>I</b>	Undercarriage ground clearance					435					330
<b>J</b>	Track height					860					860
<b>K</b>	Track gauge					2,000					2,000
<b>L</b>	Track pad width	500	600	700	850					500 600 700	
<b>M</b>	Width over tracks	2,500	2,600	2,700	2,850					2,500 2,600 2,700	
<b>N</b>	Width over steps	2,500	2,500	2,700 <sup>1)</sup>	2,800 <sup>1)</sup>					2,500 2,500 2,700 <sup>1)</sup>	
<b>O</b>	Blade width					-					2,500 2,600 2,700
<b>P</b>	Max. blade height					-					580
<b>Q</b>	Max. blade depth					-					630

<sup>1)</sup> width with removable steps

		Stick length	Mono boom 4.65 m with quick coupler	Two-piece boom 4.90 m with quick coupler
		m	mm	mm
<b>R</b>	Front swing radius	2.25	2,350	2,500
		2.45	2,300	2,450
		2.65	2,300	2,550
<b>S</b>	Height with boom up		6,700	7,050
<b>T</b>	Boom height	2.25	2,850	2,850
		2.45	2,900	2,900
		2.65	3,000	2,950
<b>U</b>	Length on ground	2.25	4,650	5,250
		2.45	4,500	5,150
		2.65	4,350	5,050
<b>V</b>	Overall length		7,500	7,700
	Bucket		0.80 m <sup>3</sup>	0.80 m <sup>3</sup>

## Transport dimensions

### removable elements disassembled

		Mono boom 4.65 m				Two-piece boom 4.90 m			
		mm				mm			
Pad width		500	600	700	850	500	600	700	850
Transport width		2,525	2,600	2,700	2,850	2,525	2,600	2,700	2,850
	Undercarriage / Stick m	LC mm	LC with blade mm		LC mm	LC with blade mm			
Transport length		7,500	8,300		7,700	8,500			
Transport height	2.25	2,895		2,895		2,900			
	2.45	2,900		2,900		2,950			
	2.65	3,000		2,950					

# Backhoe bucket

with mono boom 4.65 m

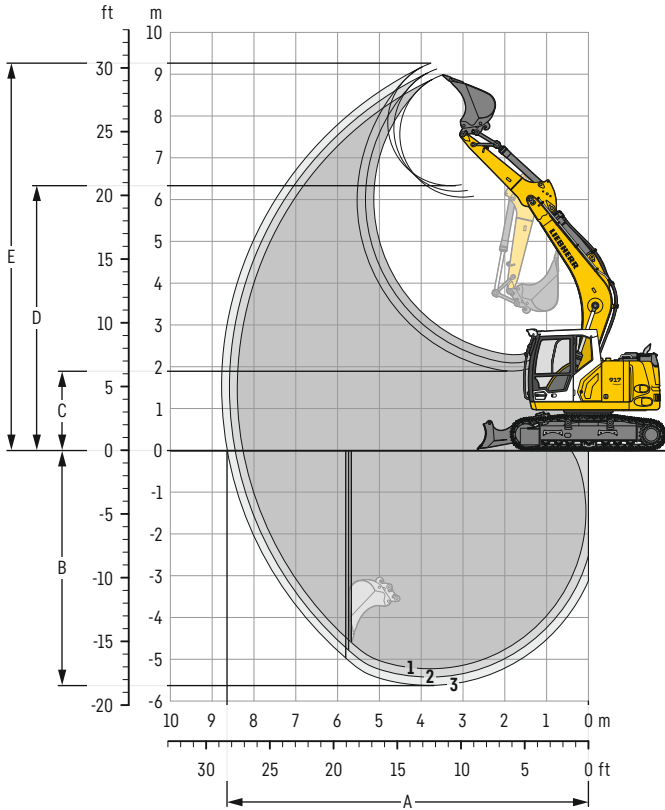

## Digging envelope

with quick coupler	1	2	3	
Stick length	m	2.25	2.45	2.65
A Max. reach at ground level	m	8.26	8.45	8.64
B Max. digging depth	m	5.23	5.43	5.63
C Min. dumping height	m	2.29	2.09	1.89
D Max. dumping height	m	6.06	6.20	6.34
E Max. cutting height	m	8.98	9.12	9.26

## Forces

without quick coupler	1	2	3	
Stick digging force (ISO 6015)	kN	77	72	68
Bucket digging force (ISO 6015)	kN	98	98	98
Stick digging force (SAE J1179)	kN	74	70	66
Bucket digging force (SAE J1179)	kN	89	89	89

## Operating weight and ground pressure

The operating weight includes the basic machine with counterweight 3.6t, mono boom 4.65m, stick 2.25m, quick coupler SWA 33 and backhoe bucket 0.80 m<sup>3</sup> (480 kg).

Undercarriage	LC				
Pad width	mm	500	600	700	850
Weight	kg	16,280	16,490	16,700	17,030
Ground pressure	kg/cm <sup>2</sup>	0.50	0.43	0.37	0.31

Undercarriage	LC with blade			
Pad width	mm	500	600	700
Weight	kg	17,510	17,720	17,930
Ground pressure	kg/cm <sup>2</sup>	0.54	0.46	0.40

## Backhoe bucket Machine stability per ISO 10567\* (75% of tipping capacity)

	Cutting width mm	Capacity ISO 7451 m <sup>3</sup>	Weight <sup>3)</sup> kg	LC undercarriage (with track pads 600 mm)						LC undercarriage with blade (with track pads 600 mm)					
				Stick length (m)						Stick length (m)					
				without quick coupler			with quick coupler			without quick coupler			with quick coupler		
	2.25	2.45	2.65	2.25	2.45	2.65	2.25	2.45	2.65	2.25	2.45	2.65			
STD <sup>1)</sup>	500	0.30	290	▲	▲	▲	▲	▲	▲	▲	▲	▲	▲	▲	▲
	650	0.42	350	▲	▲	▲	▲	▲	▲	▲	▲	▲	▲	▲	▲
	850	0.60	400	▲	▲	▲	▲	▲	▲	▲	▲	▲	▲	▲	▲
	1,050	0.80	480	▲	▲	▲	▲	▲	▲	▲	▲	▲	▲	▲	▲
	1,250	0.95	525	■	▲	■	▲	▲	■	▲	▲	■	▲	▲	■
HD <sup>2)</sup>	500	0.30	320	▲	▲	▲	▲	▲	▲	▲	▲	▲	▲	▲	▲
	650	0.42	390	▲	▲	▲	▲	▲	▲	▲	▲	▲	▲	▲	▲
	850	0.60	450	▲	▲	▲	▲	▲	▲	▲	▲	▲	▲	▲	▲
	1,050	0.80	540	▲	▲	■	▲	■	■	▲	▲	▲	▲	▲	▲
	1,250	0.95	595	▲	■	■	▲	■	■	▲	▲	■	▲	■	▲

\* indicated loads are based on ISO 10567, at maximum reach, and may be swung 360° on firm and even ground

<sup>1)</sup> Standard backhoe bucket with Liebherr teeth Z 50

<sup>2)</sup> HD backhoe bucket with Liebherr teeth Z 50

<sup>3)</sup> backhoe bucket for direct mounting or mounting to quick coupler

Other backhoe buckets available upon request

Max. material weight ▲ = 2.0t/m<sup>3</sup>, ■ = 1.8t/m<sup>3</sup>, ▲ = 1.65t/m<sup>3</sup>, ■ = 1.5t/m<sup>3</sup>

# Backhoe bucket

with two-piece boom 4.90 m

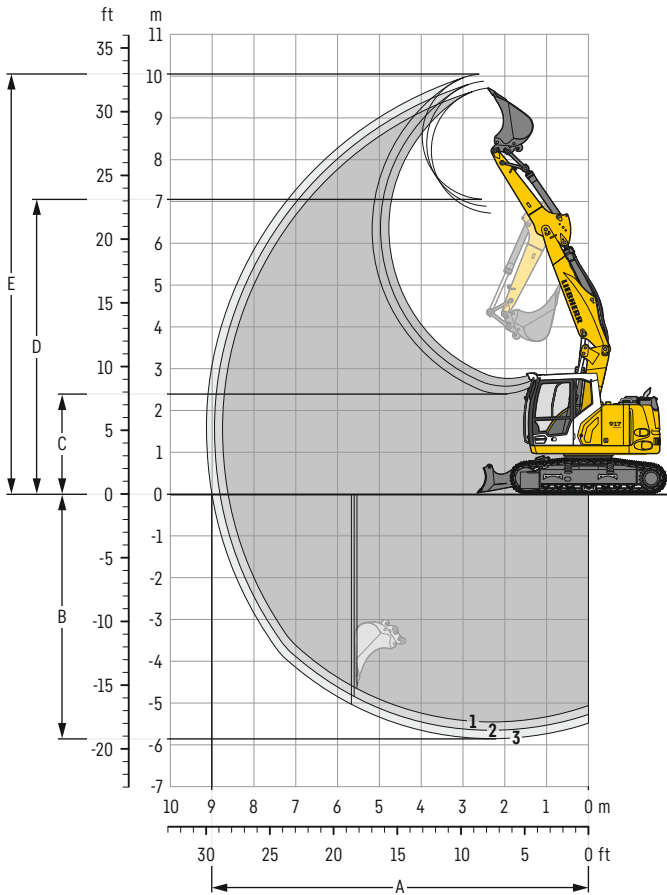

## Digging envelope

with quick coupler		1	2	3
Stick length	m	2.25	2.45	2.65
A Max. reach at ground level	m	8.62	8.81	9.01
B Max. digging depth	m	5.45	5.65	5.85
C Min. dumping height	m	2.76	2.58	2.40
D Max. dumping height	m	6.72	6.89	7.05
E Max. cutting height	m	9.71	9.88	10.05

## Forces

without quick coupler		1	2	3
Stick digging force (ISO 6015)	kN	77	72	68
Bucket digging force (ISO 6015)	kN	98	98	98
Stick digging force (SAE J1179)	kN	74	70	66
Bucket digging force (SAE J1179)	kN	89	89	89

## Operating weight and ground pressure

The operating weight includes the basic machine with counterweight 3.6t, two-piece boom 4.90 m, stick 2.25 m, quick coupler SWA 33 and backhoe bucket 0.80 m<sup>3</sup> (480 kg).

Undercarriage		LC			
Pad width	mm	500	600	700	850
Weight	kg	16,770	16,980	17,200	17,530
Ground pressure	kg/cm <sup>2</sup>	0.52	0.44	0.38	0.32

Undercarriage		LC with blade		
Pad width	mm	500	600	700
Weight	kg	18,000	18,210	18,430
Ground pressure	kg/cm <sup>2</sup>	0.56	0.47	0.41

## Backhoe bucket Machine stability per ISO 10567\* (75% of tipping capacity)

	Cutting width mm	Capacity ISO 7451 m <sup>3</sup>	Weight <sup>3)</sup> kg	LC undercarriage (with track pads 600 mm)						LC undercarriage with blade (with track pads 600 mm)					
				Stick length (m)						Stick length (m)					
				without quick coupler			with quick coupler			without quick coupler			with quick coupler		
	2.25	2.45	2.65	2.25	2.45	2.65	2.25	2.45	2.65	2.25	2.45	2.65			
STD <sup>1)</sup>	500	0.30	290	▲	▲	▲	▲	▲	▲	▲	▲	▲	▲	▲	▲
	650	0.42	350	▲	▲	▲	▲	▲	▲	▲	▲	▲	▲	▲	▲
	850	0.60	400	▲	▲	▲	▲	▲	▲	▲	▲	▲	▲	▲	▲
	1,050	0.80	480	■	▲	▲	▲	▲	▲	▲	▲	▲	▲	▲	■
	1,250	0.95	525	■	■	■	■	■	■	—	■	▲	▲	■	■
HD <sup>2)</sup>	500	0.30	320	▲	▲	▲	▲	▲	▲	▲	▲	▲	▲	▲	▲
	650	0.42	390	▲	▲	▲	▲	▲	▲	▲	▲	▲	▲	▲	▲
	850	0.60	450	▲	▲	▲	▲	▲	▲	▲	▲	▲	▲	▲	▲
	1,050	0.80	540	▲	▲	■	▲	■	■	▲	▲	■	▲	■	■
	1,250	0.95	595	■	■	—	■	▲	—	▲	▲	■	▲	■	■

\* indicated loads are based on ISO 10567, at maximum reach, and may be swung 360° on firm and even ground

<sup>1)</sup> Standard backhoe bucket with Liebherr teeth Z 50

<sup>2)</sup> HD backhoe bucket with Liebherr teeth Z 50

<sup>3)</sup> backhoe bucket for direct mounting or mounting to quick coupler

Other backhoe buckets available upon request

Max. material weight ▲ = 2.0t/m<sup>3</sup>, ■ = 1.8t/m<sup>3</sup>, ▲ = 1.65t/m<sup>3</sup>, ■ = 1.5t/m<sup>3</sup>, ▲ = 1.2t/m<sup>3</sup>, — = not authorised

# Lift capacities

with mono boom 4.65 m, counterweight 3.6 t and track pads 600 mm

## Stick 2.25 m

Under-carriage	m	3.0m		4.5m		6.0m		7.5m		m		
LC	7.5									3.6*	3.6*	3.1
	6.0									2.8*	2.8*	5.1
	4.5									2.4	2.6*	6.2
	3.0	7.0	8.7*	3.8	5.8	2.4	3.7			2.0	2.6*	6.7
	1.5	6.1	6.5*	3.4	5.5	2.3	3.5			1.8	2.8*	6.9
	0	5.8	7.3*	3.2	5.2	2.2	3.4			1.9	2.9	6.7
	-1.5	5.8	10.5	3.2	5.1	2.2	3.4			2.1	3.2	6.2
-3.0	5.9	8.7*	3.2	5.2					2.7	4.3	5.2	
LC Blade up	7.5									3.6*	3.6*	3.1
	6.0			4.4	4.8*					2.8*	2.8*	5.1
	4.5			4.3	5.0*	2.7	3.6*			2.6	2.6*	6.2
	3.0	7.5	8.7*	4.1	6.0*	2.6	3.8			2.2	2.6*	6.7
	1.5	6.5*	6.5*	3.7	5.7	2.5	3.7			2.0	2.8*	6.9
	0	6.3	7.3*	3.5	5.5	2.4	3.6			2.0	3.0	6.7
	-1.5	6.3	10.8*	3.4	5.4	2.4	3.5			2.3	3.4	6.2
-3.0	6.5	8.7*	3.5	5.5					3.0	4.5	5.2	
LC Blade down	7.5									3.6*	3.6*	3.1
	6.0			4.6	4.8*					2.8*	2.8*	5.1
	4.5			4.5	5.0*	2.8	3.6*			2.6*	2.6*	6.2
	3.0	8.0	8.7*	4.3	6.0*	2.7	5.0*			2.3	2.6*	6.7
	1.5	6.5*	6.5*	3.9	7.1*	2.6	5.4*			2.1	2.8*	6.9
	0	6.7	7.3*	3.7	7.6*	2.5	5.6*			2.1	3.1*	6.7
	-1.5	6.7	10.8*	3.7	7.4*	2.5	5.3*			2.4	3.9*	6.2
-3.0	6.9	8.7*	3.7	6.0*					3.1	4.9*	5.2	

## Stick 2.45 m

Under-carriage	m	3.0m		4.5m		6.0m		7.5m		m		
LC	7.5									3.1*	3.1*	3.5
	6.0									2.5*	2.5*	5.4
	4.5			4.2	4.5*					2.2	2.3*	6.4
	3.0	7.1	8.2*	3.8	5.8*	2.4	3.7			1.9	2.3*	6.9
	1.5	6.1	8.1*	3.5	5.5	2.3	3.5			1.8	2.5*	7.1
	0	5.8	7.5*	3.2	5.2	2.2	3.4			1.8	2.8	6.9
	-1.5	5.7	10.5	3.1	5.1	2.1	3.3			2.0	3.1	6.4
-3.0	5.9	9.1*	3.2	5.2					2.5	4.0	5.4	
LC Blade up	7.5									3.1*	3.1*	3.5
	6.0			4.5	4.5*					2.5*	2.5*	5.4
	4.5			4.4	4.8*	2.7	3.9*			2.3*	2.3*	6.4
	3.0	7.7	8.2*	4.1	5.8*	2.6	3.8			2.1	2.3*	6.9
	1.5	6.6	8.1*	3.7	5.7	2.5	3.7			1.9	2.5*	7.1
	0	6.3	7.5*	3.5	5.5	2.4	3.6			1.9	2.8*	6.9
	-1.5	6.3	11.0*	3.4	5.4	2.3	3.5			2.1	3.2	6.4
-3.0	6.4	9.1*	3.5	5.4					2.7	4.2	5.4	
LC Blade down	7.5									3.1*	3.1*	3.5
	6.0			4.5*	4.5*					2.5*	2.5*	5.4
	4.5			4.6	4.8*	2.8	3.9*			2.3*	2.3*	6.4
	3.0	8.1	8.2*	4.3	5.8*	2.7	4.9*			2.2	2.3*	6.9
	1.5	7.1	8.1*	3.9	6.9*	2.6	5.3*			2.0	2.5*	7.1
	0	6.7	7.5*	3.7	7.6*	2.5	5.6*			2.0	2.8*	6.9
	-1.5	6.7	11.0*	3.6	7.4*	2.5	5.4*			2.3	3.5*	6.4
-3.0	6.8	9.1*	3.7	6.3*					2.9	4.8*	5.4	

## Stick 2.65 m

Under-carriage	m	3.0m		4.5m		6.0m		7.5m		m		
LC	7.5									2.8*	2.8*	3.9
	6.0									2.3*	2.3*	5.6
	4.5			4.2	4.2*					2.1*	2.1*	6.6
	3.0	7.3	7.7*	3.8	5.6*	2.4	3.7			1.8	2.1*	7.1
	1.5	6.2	9.9*	3.5	5.5	2.3	3.5			1.7	2.2*	7.3
	0	5.8	7.8*	3.2	5.2	2.2	3.4			1.7	2.5*	7.1
	-1.5	5.7	10.4	3.1	5.1	2.1	3.3			1.9	2.9	6.6
-3.0	5.8	9.5*	3.1	5.1					2.3	3.7	5.6	
LC Blade up	7.5									2.8*	2.8*	3.9
	6.0			4.2*	4.2*					2.3*	2.3*	5.6
	4.5			4.4	4.6*	2.7	4.0			2.1*	2.1*	6.6
	3.0	7.7*	7.7*	4.1	5.6*	2.6	3.8			2.0	2.1*	7.1
	1.5	6.7	9.9*	3.8	5.8	2.5	3.7			1.8	2.2*	7.3
	0	6.3	7.8*	3.5	5.5	2.4	3.5			1.9	2.5*	7.1
	-1.5	6.2	10.7*	3.4	5.3	2.3	3.5			2.0	3.1	6.6
-3.0	6.3	9.5*	3.4	5.4					2.5	3.9	5.6	
LC Blade down	7.5									2.8*	2.8*	3.9
	6.0			4.2*	4.2*					2.3*	2.3*	5.6
	4.5			4.6*	4.6*	2.9	4.0*			2.1*	2.1*	6.6
	3.0	7.7*	7.7*	4.3	5.6*	2.8	4.7*			2.1	2.1*	7.1
	1.5	7.2	9.9*	4.0	6.8*	2.6	5.2*			1.9	2.2*	7.3
	0	6.7	7.8*	3.7	7.5*	2.5	5.5*			2.0	2.5*	7.1
	-1.5	6.6	10.7*	3.6	7.5*	2.4	5.4*			2.1	3.1*	6.6
-3.0	6.7	9.5*	3.6	6.5*					2.7	4.4*	5.6	

Height Can be slewed through 360° In longitudinal position of undercarriage Max. reach \* Limited by hydr. capacity

The load values are quoted in tons (t) at stick end (without bucket), and may be swung 360° on firm and even ground. Adjacent values are valid for the undercarriage when in the longitudinal position. Capacities are valid for 600 mm wide track pads. Indicated loads are based on ISO 10567 standard and do not exceed 75% of tipping or 87% of hydraulic capacity (indicated via \*). Without bucket cylinder, link and lever the lift capacities will increase by 228 kg. Lifting capacity of the excavator is limited by machine stability and hydraulic capacity.

According to European Standard, EN 474-5: In the European Union excavators have to be equipped with an overload warning device, a load diagram and automatic safety check valves on hoist cylinders and stick cylinder(s), when they are used for lifting operations which require the use of lifting accessories.

Determine maximum load lift from load lift chart displayed in the operator's cab or from load lift chart detailed in the operator's manual supplied with the machine.

# Lift capacities

with two-piece boom 4.90 m, counterweight 3.6 t and track pads 600 mm

## Stick 2.25 m

Under-carriage	m	3.0m		4.5m		6.0m		7.5m		m		
LC	7.5	5.7*	5.7*							3.6*	3.6*	3.9
	6.0									2.7	2.8*	5.6
	4.5	6.3*	6.3*	4.3	6.1*	2.5	3.8			2.0	2.6*	6.6
	3.0	7.5	10.2*	4.2	6.0	2.5	3.8			1.7	2.6*	7.1
	1.5	7.3*	10.9*	4.1	5.9	2.4	3.7			1.6	2.6	7.3
	0	7.0	11.3	3.8	5.9	2.3	3.5			1.6	2.6	7.1
	-1.5	6.6	11.6	3.5	5.6	2.1	3.4			1.8	2.9	6.6
-3.0	6.4	11.4	3.3	5.3					2.9	4.2*	4.7	
LC Blade up	7.5	5.7*	5.7*							3.6*	3.6*	3.9
	6.0			4.5	5.4*					2.8*	2.8*	5.6
	4.5	6.3*	6.3*	4.5	6.1*	2.7	3.9			2.2	2.6*	6.6
	3.0	7.9	10.2*	4.4	6.2	2.7	3.9			1.9	2.6*	7.1
	1.5	7.7	10.9*	4.4	6.1	2.6	3.8			1.8	2.7*	7.3
	0	7.5	11.6	4.1	6.2	2.5	3.7			1.8	2.7	7.1
	-1.5	7.1	11.9	3.8	5.8	2.3	3.5			2.0	3.0	6.6
-3.0	6.9	11.5*	3.6	5.6					3.2	4.2*	4.7	
LC Blade down	7.5	5.7*	5.7*							3.6*	3.6*	3.9
	6.0			4.7	5.4*					2.8*	2.8*	5.6
	4.5	6.3*	6.3*	4.7	6.1*	2.8	5.1*			2.3	2.6*	6.6
	3.0	8.3	10.2*	4.6	6.8*	2.8	5.3*			2.0	2.6*	7.1
	1.5	8.1	10.9*	4.6	7.4*	2.8	5.5*			1.9	2.7*	7.3
	0	8.0	11.8*	4.3	7.5*	2.6	5.6*			1.9	2.9*	7.1
	-1.5	7.5	12.0*	4.0	7.8*	2.5	5.1*			2.1	3.5*	6.6
-3.0	7.3	11.5*	3.8	6.3*					3.3	4.2*	4.7	

## Stick 2.45 m

Under-carriage	m	3.0m		4.5m		6.0m		7.5m		m		
LC	7.5									3.2*	3.2*	4.2
	6.0									2.6*	2.6*	5.9
	4.5	5.4*	5.4*	4.3	5.0*					1.9	2.4*	6.8
	3.0	7.5	10.0*	4.2	6.0	2.6	3.8			1.7	2.3*	7.3
	1.5	7.3	10.8*	4.1	5.9	2.5	3.7			1.5	2.4*	7.4
	0	7.1	11.2	3.8	6.0	2.3	3.6			1.6	2.5	7.3
	-1.5	6.6	11.6	3.5	5.6	2.1	3.4			1.7	2.8	6.8
-3.0	6.4	11.4	3.3	5.3					2.3	3.5*	5.6	
LC Blade up	7.5									3.2*	3.2*	4.2
	6.0			4.6	5.0*					2.6*	2.6*	5.9
	4.5	5.4*	5.4*	4.5	5.8*	2.7	4.0			2.1	2.4*	6.8
	3.0	7.9	10.0*	4.4	6.2	2.7	4.0			1.8	2.3*	7.3
	1.5	7.7	10.8*	4.4	6.1	2.7	3.9			1.7	2.4*	7.4
	0	7.6	11.5	4.1	6.2	2.5	3.7			1.7	2.6	7.3
	-1.5	7.1	11.8	3.8	5.9	2.3	3.6			1.9	2.9	6.8
-3.0	6.9	11.9	3.6	5.6					2.5	3.5*	5.6	
LC Blade down	7.5									3.2*	3.2*	4.2
	6.0			4.8	5.0*					2.6*	2.6*	5.9
	4.5	5.4*	5.4*	4.7	5.8*	2.9	4.9*			2.2	2.4*	6.8
	3.0	8.3	10.0*	4.6	6.7*	2.9	5.2*			1.9	2.3*	7.3
	1.5	8.1	10.8*	4.6	7.4*	2.8	5.5*			1.8	2.4*	7.4
	0	8.0	11.7*	4.3	7.5*	2.6	5.5*			1.8	2.6*	7.3
	-1.5	7.5	12.0*	4.0	7.6*	2.5	5.3*			2.0	3.1*	6.8
-3.0	7.3	12.0*	3.8	6.8*					2.6	3.5*	5.6	

## Stick 2.65 m

Under-carriage	m	3.0m		4.5m		6.0m		7.5m		m		
LC	7.5			3.1*	3.1*					2.8*	2.8*	4.6
	6.0			4.3	4.6*	2.5	2.9*			2.3*	2.3*	6.1
	4.5	4.7*	4.7*	4.3	5.2*	2.6	3.9			1.8	2.1*	7.0
	3.0	7.5	9.6*	4.2	6.0	2.6	3.9			1.6	2.1*	7.5
	1.5	7.3	10.8*	4.1	5.9	2.5	3.8	1.5	2.4	1.5	2.2*	7.6
	0	7.1	11.1	3.8	5.9	2.3	3.6			1.5	2.4*	7.5
	-1.5	6.6	11.5	3.6	5.7	2.1	3.4			1.6	2.6	7.0
-3.0	6.4	11.5	3.3	5.3	2.1	3.3*			2.0	3.2*	6.0	
LC Blade up	7.5			3.1*	3.1*					2.8*	2.8*	4.6
	6.0			4.6	4.6*	2.7	2.9*			2.3*	2.3*	6.1
	4.5	4.7*	4.7*	4.5	5.2*	2.8	4.0			2.0	2.1*	7.0
	3.0	8.0	9.6*	4.4	6.2	2.8	4.0			1.7	2.1*	7.5
	1.5	7.7	10.8*	4.3	6.1	2.7	3.9	1.7	2.6	1.6	2.2*	7.6
	0	7.6	11.4	4.1	6.1	2.5	3.7			1.6	2.4*	7.5
	-1.5	7.1	11.7	3.9	5.9	2.3	3.6			1.8	2.7	7.0
-3.0	6.9	12.0	3.6	5.6	2.3	3.3*			2.2	3.2*	6.0	
LC Blade down	7.5			3.1*	3.1*					2.8*	2.8*	4.6
	6.0			4.6*	4.6*	2.8	2.9*			2.3*	2.3*	6.1
	4.5	4.7*	4.7*	4.7	5.2*	2.9	4.7*			2.1	2.1*	7.0
	3.0	8.3	9.6*	4.6	6.5*	2.9	5.1*			1.8	2.1*	7.5
	1.5	8.1	10.8*	4.5	7.3*	2.8	5.4*	1.8	3.2*	1.7	2.2*	7.6
	0	8.1	11.5*	4.3	7.4*	2.7	5.5*			1.7	2.4*	7.5
	-1.5	7.6	11.9*	4.1	7.6*	2.5	5.4*			1.9	2.8*	7.0
-3.0	7.4	12.2*	3.8	7.1*	2.4	3.3*			2.4	3.2*	6.0	

Height Can be slewed through 360° In longitudinal position of undercarriage Max. reach \* Limited by hydr. capacity

The load values are quoted in tons (t) at stick end (without bucket), and may be swung 360° on firm and even ground. Adjacent values are valid for the undercarriage when in the longitudinal position. Capacities are valid for 600 mm wide track pads with adjusting cylinder in optimal position. Indicated loads are based on ISO 10567 standard and do not exceed 75% of tipping or 87% of hydraulic capacity (indicated via \*). Without bucket cylinder, link and lever the lift capacities will increase by 228 kg. Lifting capacity of the excavator is limited by machine stability and hydraulic capacity. According to European Standard, EN 474-5: In the European Union excavators have to be equipped with an overload warning device, a load diagram and automatic safety check valves on hoist cylinders and stick cylinder(s), when they are used for lifting operations which require the use of lifting accessories. Determine maximum load lift from load lift chart displayed in the operator's cab or from load lift chart detailed in the operator's manual supplied with the machine.

# Attachments

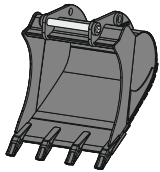

## Backhoe bucket TL 03

Mounting		direct mounting, SWA 33 mechanical, SWA 33 hydraulic, SWA 33 Solidlink, SWA 48 mechanical, SWA 48 hydraulic, SWA 48 Solidlink							
Cutting width	mm	300 <sup>3)4)</sup>	400 <sup>3)4)</sup>	500 <sup>4)</sup>	650	750	850	1,050	1,250
Capacity	m <sup>3</sup>	0.17 <sup>5)</sup>	0.24 <sup>5)</sup>	0.32	0.42	0.50	0.60	0.80	0.95
Weight <sup>2)</sup>	kg	270	290	295	375	395	435	510	555

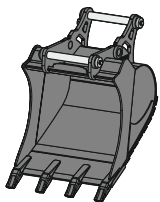

## 2in1 bucket HTL 03

Mounting		SWA 33 mechanical, SWA 33 hydraulic, SWA 33 Solidlink, SWA 48 mechanical, SWA 48 hydraulic, SWA 48 Solidlink							
Cutting width	mm	300 <sup>3)</sup>	400 <sup>3)</sup>	500 <sup>2)4)</sup>	650 <sup>2)</sup>	850 <sup>2)</sup>	1,050 <sup>2)</sup>	1,250 <sup>2)</sup>	
Capacity	m <sup>3</sup>	0.17	0.24	0.32	0.42	0.60	0.80	0.95	
Weight	kg	280	290	413	450	510	584	628	

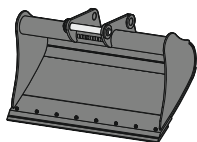

## Universal bucket

Mounting		SWA 33 mechanical, SWA 33 hydraulic, SWA 33 Solidlink, SWA 48 mechanical, SWA 48 hydraulic, SWA 48 Solidlink							
<b>UL 03</b>									
Cutting width	mm	1,500							
Capacity	m <sup>3</sup>	0.60							
Weight <sup>1)</sup>	kg	368							
<b>UL 04</b>									
Cutting width	mm	1,600				1,600			
Capacity	m <sup>3</sup>	0.80				1.00			
Weight <sup>2)</sup>	kg	473				496			

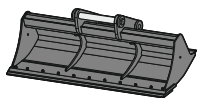

## Ditch cleaning bucket GRL rigid 02

Mounting		direct mounting, SWA 33 mechanical, SWA 33 hydraulic, SWA 33 Solidlink, SWA 48 mechanical, SWA 48 hydraulic, SWA 48 Solidlink							
Cutting width	mm	1,500		2,000		2,000			
Capacity	m <sup>3</sup>	0.50		0.48		0.65			
Weight <sup>1)</sup>	kg	362		351		385			

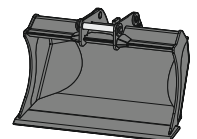

## Grading bucket PL 03

Mounting		SWA 33 mechanical, SWA 33 hydraulic, SWA 33 Solidlink, SWA 48 mechanical, SWA 48 hydraulic, SWA 48 Solidlink							
Cutting width	mm	1,400				1,600			
Capacity	m <sup>3</sup>	0.65				0.75			
Weight <sup>1)</sup>	kg	350				390			

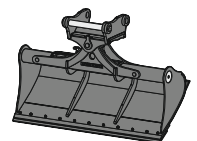

## Ditch cleaning bucket with hydraulic cylinder GRL 90

Mounting		direct mounting, SWA 33 mechanical, SWA 33 hydraulic, SWA 33 Solidlink, SWA 48 mechanical, SWA 48 hydraulic, SWA 48 Solidlink											
Cutting width	mm	1,600	1,600	2,000	2,000	2,000	2,200	2,200	2,200	2,400	2,400	2,800	
Capacity	m <sup>3</sup>	0.55	0.80	0.50	0.70	1.00	0.80	1.15	1.40	0.85	1.25	1.85	
Weight <sup>2)</sup>	kg	690	850	695	875	935	910	985	995	890	1,000	1,090	
Tilt angle		2 x 50°	2 x 50°	2 x 50°	2 x 50°	2 x 50°	2 x 50°	2 x 50°	2 x 50°	2 x 50°	2 x 50°	2 x 50°	

<sup>1)</sup> based on an attachment in a standard design with SWA 33 Solidlink quick coupler mounting

<sup>2)</sup> based on an attachment in a standard design with SWA 48 Solidlink quick coupler mounting

<sup>3)</sup> limited digging depth due to mounting for SWA 33 quick coupler

<sup>4)</sup> limited digging depth due to mounting for SWA 48 quick coupler

<sup>5)</sup> reduced capacity with direct mounting

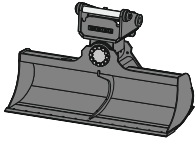

### Ditch cleaning bucket with rotary motor GRLM 20

Mounting	SWA 33 mechanical, SWA 33 hydraulic, SWA 33 Solidlink, SWA 48 mechanical, SWA 48 hydraulic, SWA 48 Solidlink				
Cutting width	mm	1,600	1,800	2,000	2,200
Capacity	m <sup>3</sup>	0.55	0.65	0.70	0.80
Weight <sup>1)</sup>	kg	688	720	753	785
Tilt angle		2 x 50°	2 x 50°	2 x 50°	2 x 50°

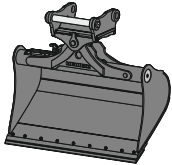

### Tilt bucket with hydraulic cylinder SL 90

Mounting	direct mounting, SWA 33 mechanical, SWA 33 hydraulic, SWA 33 Solidlink, SWA 48 mechanical, SWA 48 hydraulic, SWA 48 Solidlink						
Cutting width	mm	1,400	1,500	1,500	1,600	1,600	1,600
Capacity	m <sup>3</sup>	0.55	0.60	1.20	0.80	1.00	1.35
Weight <sup>2)</sup>	kg	715	738	970	820	890	970
Tilt angle		2 x 50°	2 x 50°	2 x 50°	2 x 50°	2 x 50°	2 x 50°

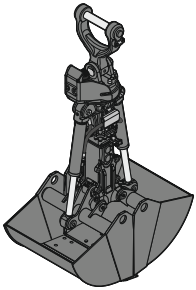

### Clamshell grab

Mounting	direct mounting, SWA 33 mechanical, SWA 33 hydraulic, SWA 33 Solidlink, SWA 48 mechanical, SWA 48 hydraulic, SWA 48 Solidlink					
<b>GMZ 18 Clamshell buckets</b>						
Shell width	mm	320	400	600	800	
Capacity <sup>3)</sup>	m <sup>3</sup>	0.17	0.22	0.30	0.40	
Opening width	mm	1,462	1,462	1,392	1,392	
Weight <sup>4)</sup>	kg	670	705	715	765	
<b>GMZ 22 Clamshell buckets</b>						
Shell width	mm	300	400	600	800	1,000
Capacity <sup>3)</sup>	m <sup>3</sup>	0.14	0.20	0.30	0.42	0.54
Opening width	mm	1,502	1,502	1,502	1,502	1,502
Weight <sup>4)</sup>	kg	680	710	780	855	935

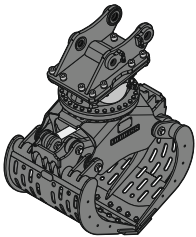

### Sorting grab

Mounting	direct mounting, SWA 33 mechanical, SWA 33 hydraulic, SWA 33 Solidlink, SWA 48 mechanical, SWA 48 hydraulic, SWA 48 Solidlink								
<b>SG 20B</b>									
Shell type	perforated				closed				
Shell width	mm	800	1,000	1,200	1,400	800	1,000	1,200	1,400
Capacity	m <sup>3</sup>	0.40	0.50	0.60	0.70	0.40	0.50	0.60	0.70
Max. closing force	kN	40	40	40	40	40	40	40	40
Weight <sup>5)</sup>	kg	750	795	840	885	765	810	850	895
<b>SG 20B with universal shell</b>									
Shell width	mm	650							
Capacity	m <sup>3</sup>	0.15							
Max. closing force	kN	57							
Weight <sup>6)</sup>	kg	831							

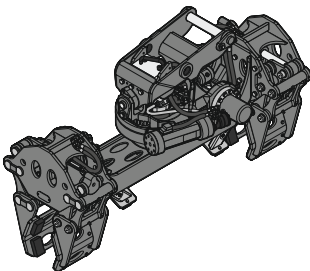

### Parallel grab GMP 25 with pole clamp<sup>8)</sup>

Mounting	SWA Solidlink 33-9	
Clamp diameter min.	mm	250
Clamp diameter max.	mm	600
Weight <sup>7)</sup>	kg	1,470

<sup>1)</sup> based on an attachment in a standard design with SWA 33 Solidlink quick coupler mounting

<sup>2)</sup> based on an attachment in a standard design with SWA 48 Solidlink quick coupler mounting

<sup>3)</sup> capacity specifications are theoretically determined values; fill level varies depending on the material being loaded

<sup>4)</sup> without suspension

<sup>5)</sup> with standard bolt-on cutting edge, without quick coupler mounting

<sup>6)</sup> with Liebherr teeth Z 35 C, without quick coupler mounting

<sup>7)</sup> based on an attachment in a standard design with SWA Solidlink 33-9 quick coupler mounting

<sup>8)</sup> on the machine side, a 14-pin signal contact strip and a power socket on the stick, switchable via signal contacts are always required

# Attachments

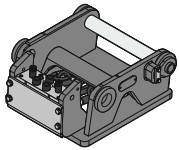

## Adapter plate

SWA 33 / SWA 48						
Version		SWA 33	SWA 33 XL	SWA 48	SWA 48 XL	SWA 48 XXL
Weight <sup>1)</sup>	kg	102	140	153	225	282
SWA 33 Solidlink / SWA 48 Solidlink						
Version		SWA 33 Solidlink	SWA 33 Solidlink XL	SWA 48 Solidlink	SWA 48 Solidlink XL	SWA 48 Solidlink XXL
Weight <sup>2)</sup>	kg	145	182	210	281	338

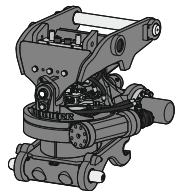

## Tiltrotator TR 25

Mounting machine side		SWA 33 mechanical, SWA 33 hydraulic, SWA 33 Solidlink, SWA 48 mechanical, SWA 48 hydraulic, SWA 48 Solidlink
Mounting attachment side		SWA 33 mechanical, SWA 33 hydraulic, SWA 48 mechanical, SWA 48 hydraulic
Weight <sup>3)</sup>	kg	787
Rotation		360°
Tilt		2 x 50°

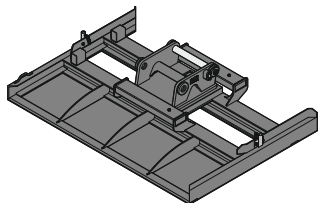

## Grading beam PB 20

Mounting		SWA 33 mechanical, SWA 33 hydraulic, SWA 33 Solidlink, SWA 48 mechanical, SWA 48 hydraulic, SWA 48 Solidlink
Cutting width	mm	2,500
Weight <sup>4)</sup>	kg	627

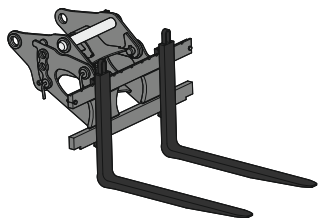

## Pallet fork

PG SWA 33 FEM III		
Mounting		SWA 33 mechanical, SWA 33 hydraulic, SWA 33 Solidlink
Fork length	mm	1,200
Max. width pallet fork	mm	1,500
Lift capacity (ISO 2328)	t	5.0
Weight	kg	579
PG SWA 48 FEM II		
Mounting		SWA 48 mechanical, SWA 48 hydraulic, SWA 48 Solidlink
Fork length	mm	1,200
Max. width pallet fork	mm	1,245
Lift capacity (ISO 2328)	t	2.5
Weight	kg	345
PG SWA 48 FEM III		
Mounting		SWA 48 mechanical, SWA 48 hydraulic, SWA 48 Solidlink
Fork length	mm	1,200
Max. width pallet fork	mm	1,500
Lift capacity (ISO 2328)	t	5.0
Weight	kg	585

<sup>1)</sup> based on a standard adapter plate with opening and with SWA 33 / SWA 48 quick coupler mounting

<sup>2)</sup> based on a standard adapter plate with opening, with full hydraulic assignment and with SWA 33 Solidlink / SWA 48 Solidlink quick coupler mounting

<sup>3)</sup> based on standard tiltrotator TR 25 with SWA 48 Solidlink quick coupler mounting machine side and SWA 48 hydraulic quick coupler mounting on the underside tiltrotator

<sup>4)</sup> based on an attachment in a standard design with SWA 33 Solidlink quick coupler mounting

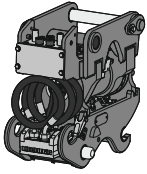

### Tilt unit LiTiU 33<sup>2)</sup>

Mounting machine side	SWA 33 Solidlink
Mounting attachment side	SWA 33 hydraulic, SWA 33 Solidlink
Weight <sup>1)</sup>	kg 410
Tilt	2 x 50°



### Load chain / Spreader bar

<b>Load chain for SWA 33 quick coupler, with load hook</b>	
Lift capacity (WLL)	t 6.7
Overall height	mm 536
Weight	kg 6
<b>Load chain for SWA 33 quick coupler, without load hook</b>	
Lift capacity (WLL)	t 6.7
Overall height	mm 246
Weight	kg 2
<b>Spreader bar for SWA 33 quick coupler, with load hook</b>	
Lift capacity (WLL)	t 10.0
Overall height	mm 745
Weight	kg 21.7

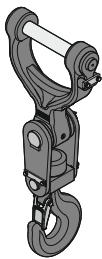

### Load hook / Lifting shackle

Mounting	SWA 33 mechanical, SWA 33 hydraulic, SWA 33 Solidlink, SWA 48 mechanical, SWA 48 hydraulic, SWA 48 Solidlink	
Version	Single load hook	Double load hook
<b>Load hook</b>		
Lift capacity (WLL)	t 12.5	12.5
Height	mm 545	535
Weight <sup>3)</sup>	kg 67	68
<b>Load hook on rotary drive</b>		
Lift capacity (WLL)	t 12.5	12.5
Height	mm 1,032	1,022
Weight <sup>3)</sup>	kg 344	345
<b>Lifting shackle</b>		
Lift capacity (WLL)	t 35	
Height	mm 226	
Weight <sup>3)</sup>	kg 26	

<sup>1)</sup> based on standard tilt unit LiTiU 33 with SWA 33 Solidlink quick coupler mountings on both sides (underside of tilt unit and machine side quick coupler mounting)

<sup>2)</sup> on the machine side, a 14-pin signal contact strip is always required; switching takes place between tilting the LiTiU and the grab rotation circle for the attachment

<sup>3)</sup> without suspension

# Serial equipment

## Undercarriage

### Track components & tracks & steps

Lashing eyes  
Track and carrier rollers, sealed and lifetime-lubricated  
Undercarriage LC, track gauge 2,000 mm

## Uppercarriage

### Hydraulic & engine

Filters accessible from ground level  
Fuel fine filter  
Fuel pre-filter and water separator  
Power Pack EU Stage V  
Pressure accumulator for controlled lowering of equipment with engine turned off

### Counterweight & inspection

Counterweight standard 3.6 t

### Options

Main switch accessible from ground level  
Main switch, electric, with timer

## Equipment

### Boom

Pipe fracture safety valve for stick cylinder  
Pipe fracture safety valves for boom cylinders

## Control

### Safety & operation

Automatic engine idling / speed increase  
Horn  
Modetronic

Positioning swing brake automatic

### Hydraulic & control

10" colour touchscreen  
Control pattern digital  
DEF level on touchscreen  
Display controller button  
Display with haptic feedback  
Fuel level on touchscreen  
High pressure circuit with Tool Control  
Hydraulic oil level on touchscreen  
Joystick proximity sensor  
Power modes  
Start/Stop button  
Touchpad 3.5"

### Assistance systems

Smartphone interface

## Cab

### Interior

Air-conditioned bottle holder  
Air-conditioned storage compartment  
Armrests adjustable in length, height and inclination  
Automatic air conditioning  
Coat hook  
Consoles linked to the seat and adjustable  
Emergency hammer with seat belt cutter  
Emergency stop hydraulic and engine in cab  
Front windscreen washer mobile spray  
Hand free kit  
Inner temperature sensor  
Interior lighting LED  
Key storage  
Liebherr Connect  
Mood lighting LED  
Outer temperature sensor  
Radio Comfort  
Roll-down sun blinds for windscreen and roof window  
Seat belt reminder  
Sockets in cab (USB)  
Solar radiation sensor  
Storage nets  
Storage space backpack  
Storage tablet  
Tiltable console left with safety lever

### Exterior

Bottom windscreen wiper  
Cab air filters, accessible from ground level  
Impact resistant roof window  
Laminated right hand side window  
Preparation for top and front guard FOPS-FGPS  
Rain hood over front window opening  
Rear window emergency exit  
Windscreen wiper  
Windshield washer fluid tank accessible from ground level

### Use & operation

DEF consumption on touchscreen  
Fuel consumption on touchscreen  
ROPS  
Swing braking torque adjustable  
Switch between high pressure circuit and bucket cylinder

# Equipment standard / option

## Undercarriage

### Track components & tracks & steps

Chain guide 1 piece	•
Chain guide 3 pieces	+
Dozer and stabilizer blade 2,500 mm	+
Dozer and stabilizer blade 2,600 mm	+
Dozer and stabilizer blade 2,700 mm	+
Rubber track pads 500 mm	+
Steps	•
Steps wide	+
Track pads triple grouser 500 / 700 / 850 mm	+
Track pads triple grouser 600 mm	•
Undercarriage storage compartment	+

## Uppercarriage

### Hydraulic & engine

Air pre-filter with cyclonical dust trap	+
Automatic engine shutdown after idling (with timer)	+
Automatic engine shutdown after idling (without timer)	+
Bypass filter for hydraulic oil	+
Hydraulic oil, Liebherr Hydraulic Basic 100 (0 to +55 °C)	+
Hydraulic oil, Liebherr Hydraulic HVI (-20 to +40 °C)	•
Hydraulic oil, Liebherr Hydraulic Plus Arctic, high performance oil (-40 to +30 °C)	+
Hydraulic oil, Liebherr Hydraulic Plus, high performance oil (-30 to +45 °C)	+
Preheating fuel	+
Reversible fan drive	+
Tank refilling pump fuel	+

### Options

Centralised lubrication automatic swing ring and equipment	•
Extended tool set including tool box	+
Headlight on uppercarriage, lateral right, LED+, 1 piece	+ )
Headlights on uppercarriage, front, LED, 2 pieces, protections included	• )
Headlights on uppercarriage, front, LED+, 2 pieces, protections included	+ )
Headlights on uppercarriage, rear, LED+, 2 pieces	+ )
Lighting for cab access	+ )
Reflective warning stickers	+
Socket on uppercarriage (24 V)	+
Tool set	•
Warning beacon on uppercarriage, rear, LED, 1 piece	+

## Equipment

### Boom

Floating boom	+
Headlight guards on boom	+
Headlights on boom, LED, 2 pieces	• )
Headlights on boom, LED+, 2 pieces	+ )
Mono boom 4.65 m	+
Two-piece boom 4.90 m	+

### Stick & attachment mounting

Bucket cylinder rod protection	+
Centralised lubrication automatic connecting link	+
Centralised lubrication automatic quick coupler	+
Coupling system Solidlink for quick coupler SWA 33	+
Coupling system Solidlink for quick coupler SWA 48	+
GPS for attachment (via 5-pin signal contacts)	+
GPS for attachment (via 14-pin signal contacts)	+
Headlights on stick, right and left, LED+, 2 pieces, protections included	+ )
Lifting eye on stick 8.0t (500 mm from stick end pin)	+
Load holding valve for bucket cylinder (both sides)	+
Quick coupler SWA 33 hydraulic	+
Quick coupler SWA 48 hydraulic	+
Signal contacts for Solidlink 5-pin	+
Signal contacts for Solidlink 5-pin and 14-pin	+
Signal contacts for Solidlink 14-pin	+
Socket on stick (24 V)	+
Stick 2.25 m	+
Stick 2.45 m	+
Stick 2.65 m	+
Stick bottom protection	+

# Equipment standard / option



## Cab

Interior	
2-points seat belt, 2"	●
2-points seat belt, 3"	+
3-points seat belt, 2"	+
Auxiliary heater programmable	+
Fire extinguisher	+
Footrest	+
Mobile phone holder with inductive charging	+
Multifunction mounting bracket	+
Operator's seat Comfort	●
Operator's seat Premium	+
Remote cab lock	+ <sup>1)</sup>
Roll-down sun blinds for rear and side window, right	+
Travel alarm system standard switchable	+
Travel pedals with travel levers removable	+
Exterior	
Electrically adjustable and heated outside rear-view mirrors	+
FGPS front guard with side opening	+
FOPS top guard	+
FOPS top guard flat	+
Headlight on cab, rear, LED+, 1 piece	+ <sup>1)</sup>
Headlights on cab, front, LED, 2 pieces	● <sup>1)</sup>
Headlights on cab, front, LED+, 2 pieces	+ <sup>1)</sup>
Impact resistant one-piece windscreen	+
Lightbar on cab, LED	+
Rearview mirror on cab	●
Retractable laminated two-piece windscreen	●
Roof window wiper	+
Warning beacon foldable on cab, LED, 1 piece	+
Use & operation	
Filter for hydraulic hammer return flow	+
Leak oil line for attachment	+



## Control

Safety & operation	
Overload warning system	+
Hydraulic & control	
Attachment continuous operation system	+
Double pedal, left	+
Double pedal, right	+
Joysticks Premium	●
Medium pressure circuit	+
Operation pallet fork	+
Preparation for tiltrotator	+
Assistance systems	
MiC 4.0 BUS communication standard	+
Preparation for machine control system	+
Rear view and right hand side view monitoring cameras	●
Skyview 360°	+
Smart Key Comfort	+
Smart Key Standard	●



## General

Coating & transport	
Special paint	+



## Packages

Coming / Leaving Home	+ <sup>1)</sup>
Luminosity control (LED+ headlights)	+ <sup>1)</sup>

● = Standard, + = Option

<sup>1)</sup> equipment not individually available, but only as predefined packages

Non-exhaustive list, please contact us for further information.

Options and /or special equipment, supplied by vendors other than Liebherr, are only to be installed with the knowledge and approval of Liebherr in order to retain warranty.

## Liebherr-France SAS

2 avenue Joseph Rey, B.P. 90287 • 68005 Colmar Cedex, France • Phone +33 389 213030  
 info.lfr@liebherr.com • www.liebherr.com • www.facebook.com/LiebherrConstruction