



User Guide

Quality, Design and Innovation



home.liebherr.com/fridge-manuals









LIEBHERR

Contents

1	Appliance at a glance.....	3
1.1	Scope of supply.....	3
1.2	Overview of appliances and equipment.....	3
1.3	Special features.....	3
1.3	Retrofitting casters.....	4
1.4	Range of use of appliance.....	4
1.5	Appliance noise emissions.....	4
1.6	Conformity.....	4
1.7	SVHC substances according to REACH regulation.....	5
1.8	EPREL database.....	5
2	General safety instructions.....	5
3	Functionality of the Touch & Swipe display.....	6
3.1	Navigation and symbol explanation.....	6
3.2	Menus.....	7
3.3	Sleep mode.....	7
4	Putting into operation.....	8
4.1	Installation conditions.....	8
4.2	Appliance dimensions.....	8
4.3	Transporting appliance.....	8
4.4	Unpacking appliance.....	9
4.5	Connect power cable.....	9
4.6	Installing appliance.....	9
4.7	Setting up the appliance so it is level.....	9
4.8	Installing multiple appliances.....	9
4.9	After installation.....	9
4.10	Disposing of packaging.....	10
4.11	Reversing the door opening direction.....	10
4.12	Aligning the door.....	10
4.13	Connecting appliance.....	10
4.14	Switching on appliance (first use).....	10
4.15	Using equipment.....	11
4.16	Centre grid shelf.....	11
5	Storage.....	11
5.1	Information regarding storage.....	11
5.2	Storage times.....	11
6	Controls.....	12
6.1	Control and display elements.....	12
6.1.1	Status display.....	12
6.1.2	Display symbols.....	12
6.1.3	Acoustic signals.....	12
6.2	Appliance functions.....	12
6.2.1	Notes on the appliance functions.....	12
6.2.2	Switching appliance on and off	13
6.2.3	Temperature	13
6.2.4	Temperature recording	13
6.2.5	Lighting	14
6.2.6	Presentation light	14
6.2.7	SuperFrost	14
6.2.8	Display lock	15
6.2.9	Access codes.....	15
6.2.10	Maintenance interval reminder	15
6.2.11	Language	15
6.2.12	Temperature unit	16
6.2.13	WiFi connection	16
6.2.14	LAN connection	17
6.2.15	Device information	18
6.2.16	Operating hours	18
6.2.17	Software	18
6.2.18	Defrosting	18
6.2.19	Door alarm	19
6.2.20	Light alarm	19
6.2.21	Demo mode	20
6.2.22	Resetting to factory settings	20
6.3	Message.....	20
6.3.1	Warnings.....	20
6.3.2	Reminders.....	22
7	Features.....	22
7.1	Safety lock.....	22

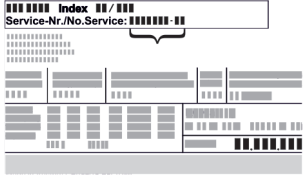
8	Maintenance.....	23
8.1	Defrosting appliance.....	23
8.2	Cleaning the appliance.....	23
9	Customer help.....	23
9.1	Technical specifications.....	23
9.2	Technical fault.....	24
9.3	Customer Service.....	24
9.4	Type plate.....	25
10	Shutting down.....	25
11	Disposal.....	25
11.1	Preparing appliance for disposal.....	25
11.2	Disposing of the appliance in an environmentally friendly manner.....	25
12	Additional information.....	25

The manufacturer is continually working on the further development of all types and models. Please be aware that we reserve the right to make changes to the shape, equipment and technology.

Symbol	Explanation
	Read instructions Please read the information in these instructions carefully to understand all of the benefits of your new appliance.
	Additional information on the Internet The digital manual with additional information and in other languages can be found via the QR code on the front of the manual or by entering the service number at home.liebherr.com/fridge-manuals . The service number can be found on the serial tag:  <i>Fig. Example illustration</i>
	Check appliance Check all parts for transport damage. If you have any complaints, please contact your agent or customer service.
	Differences These instructions apply to a range of models, so differences are possible. Sections that apply to certain models only are marked with an asterisk (*).
	Instructions and results Instructions are marked with a ▶. Results are marked with a ▷.
	Videos Videos about the appliances are available on the YouTube channels of Liebherr-Hausgeräte.

These operating instructions apply to:

- FFPSrh 1402
- FFPSrh 6501

1 Appliance at a glance

1.1 Scope of supply

Check all parts for transport damage. If you have any complaints, please contact your dealer or Customer Service. (see 9.3 Customer Service)

The delivery comprises the following parts:

- Free-standing appliance
- Equipment *
- Installation materials *
- Operating instructions
- Service brochure
- Quality certificate *
- Mains cable

1.2 Overview of appliances and equipment

FFPSrh 6501

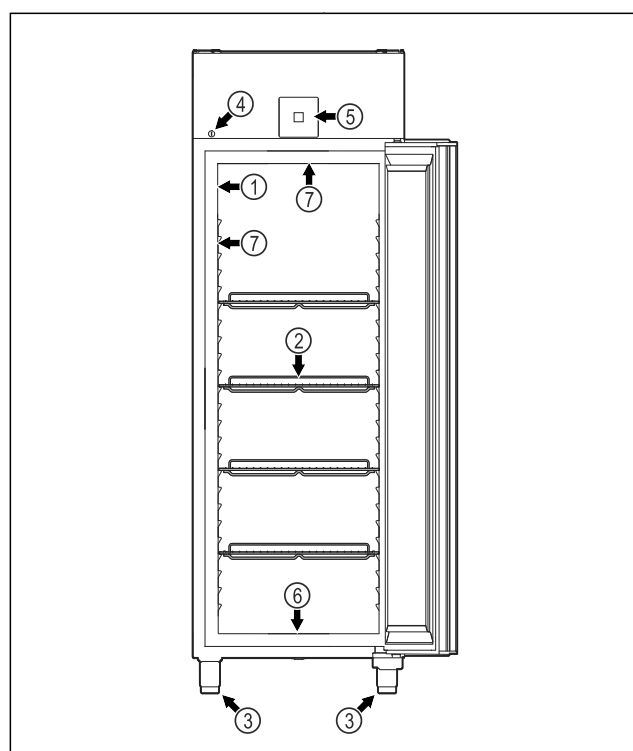

Fig. 1 Example illustration

- | | |
|--------------------|--|
| (1) Type plate | (5) Control elements and temperature display |
| (2) Grid shelves | (6) Drain hole for water from cleaning |
| (3) Adjusting feet | (7) Interior lighting * |
| (4) Lock | |

FFPSrh 1402

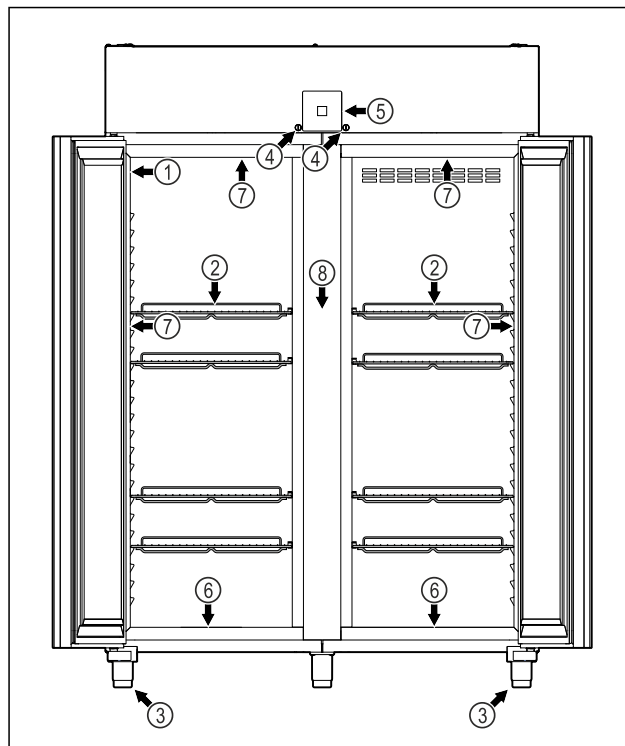

Fig. 2 Example illustration

- | | |
|--------------------|--|
| (1) Type plate | (5) Control elements and temperature display |
| (2) Grid shelves | (6) Drain hole for water from cleaning |
| (3) Adjusting feet | (7) Interior lighting * |
| (4) Lock | (8) Centre grid shelf |

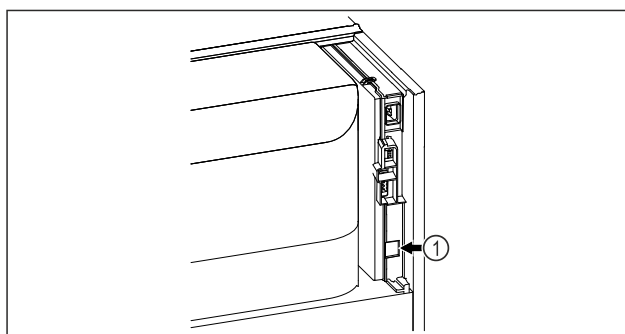

Fig. 3 Example illustration

- (1) LAN interface

1.3 Special features

Note

Accessories are available from Customer Service (see 9.3 Customer Service) and the Liebherr-Hausgeräte store at home.liebherr.com/shop/de/deu/zubehor.html.

SmartModule

The appliance is fitted with a SmartModule.

This is a WiFi and LAN interface for the connection between the appliance and an external documentation and alarm system such as Liebherr SmartMonitoring.

Liebherr SmartMonitoring Dashboard is not available in all countries. Check availability via the QR code (see 6.2.13 WiFi connection) by entering your model.

Appliance at a glance

1.3 Retrofitting casters



DANGER

Conversion from adjustable feet to casters!
Risk of injury and damage due to tipping. Some appliances may only be operated with adjustable feet.

- ▶ Do **not** convert the appliance to casters.
- ▶ Please note the following list.

Appliances for which you may not replace adjustable feet with casters:
FRPSvg 1412
FRPSvh 1412
FRPSrh 1412



DANGER

Conversion from adjustable feet to casters!
Risk of injury and damage due to tipping. If you convert to casters, you must pay attention to the fitting position of the casters.

- ▶ Fit casters to the front of the appliance.
- ▶ Fit the fixed caster on the rear of the appliance.
- ▶ Please note the following list.

Appliances where you need to pay attention to the fitting position of the casters:
FRPSvg 6511
FRPSvh 6511
FRPSrh 6511

1.4 Range of use of appliance

Intended use

This freezer is appropriate for the professional storage of frozen foodstuffs. This appliance is not intended for the presentation or removal of foodstuffs by customers.

The appliance is designed for use in indoor spaces.

All other types of use are not permitted.

Foreseeable incorrect use

The following uses are expressly forbidden:

- Storage and refrigeration of:
 - Chemically unstable flammable or corrosive substances
 - Medicines, blood plasma, laboratory preparations or similar substances and products based on the Medical Device Directive 2007/47/EC
- Use in potentially explosive atmospheres
- Use outdoors or in areas exposed to dampness and splashing water
- Use in residential areas because adequate protection of radio reception cannot be ensured in such environments.*

Improper use of the appliance will result in goods stored being damaged or spoiled.

Climate classes

The applicable climate class for your appliance is printed on the type plate.

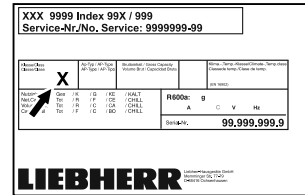

Fig. 4 Type plate

(X) The climate class states the ambient conditions in which the appliance can be operated safely.

Climate class (X)	Max. room temperature	Max. rel. humidity
3	+25 °C	60 %
4	+30 °C	55 %
5	+40 °C	40 %
7	+35 °C	75 %

Note

The minimum permitted room temperature at the setup location is +10 °C.

At limit conditions, slight condensation may form on the glass door (depending on the equipment) and on the side walls.

Recommended temperature setting:

Temperature class (Z)	Temperature setting
L1	-18 °C
M1	+5 °C

1.5 Appliance noise emissions

The A-weighted emission sound pressure level during operation of the appliance is under 70 dB(A) (sound power rel. 1 pW).

1.6 Conformity

The coolant circuit has been tested for leak-tightness. The appliance complies with the relevant safety regulations.

EU Declaration of Conformity

Manufacturer/Exhibitor: LIEBHERR-HAUSGERÄTE LIENZ GMBH
Address: A-9900 Lienz, Dr. Hans Liebherr Straße 1

The designated product complies with the provisions of the following European directives and regulations:

EU Declaration of Conformity

(EU) 2019/2020, (EU) 2015/1095, (EU) 2015/1094, (EU) 2017/1369, 2006/42/EC, 2014/30/EU, 2009/125/EC, 2011/65/EU

The built-in radio module complies with Directive 2014/53/EU. Information on the radio module (see 9.1 Technical specifications).

The full text of the EU Declaration of Conformity is available at the following web address: www.liebherr.de

1.7 SVHC substances according to REACH regulation

You can check whether your appliance contains SVHC substances according to REACH regulation at the following link: home.liebherr.com/de/deu/de/liebherr-erleben/nachhaltigkeit/umwelt/scip/scip.html

1.8 EPREL database

Details about the labelling of energy consumption and ecodesign requirements will be available on the European Product Database (EPREL) from 1 March 2021. You can access the product database at the following link: <https://eprel.ec.europa.eu/>. You will be asked to enter the model identification. The model identification can be found on the type plate.

2 General safety instructions

Please keep these operating instructions in a safe place so you can refer back to them at any time.

If you pass the appliance on, please hand these operating instructions to the next user.

Read these operating instructions carefully before use to ensure safe and correct use of the appliance. Follow the instructions, safety instructions and warning messages included at all times. They are important for ensuring you can operate and install the appliance safely and without any problems.

Danger for the user:

- This device can be used by children aged 8 and above and people with impaired physical, sensory or mental abilities or with a lack of experience and knowledge provided that they are supervised or have received instruction in the safe use of this appliance, and about the resulting hazards. Children must not play with this appliance. Cleaning and user maintenance work must not be carried out by children without adult supervision.
- The socket must be easily accessible so that the appliance can be disconnected quickly from the electricity supply in an emergency. It must not be located in the area behind the appliance.

- When disconnecting the appliance from the supply, always take hold of the plug. Do not pull the cable.
- In the event of a fault pull out the mains plug or deactivate the fuse.
- **WARNING:** Do not damage the mains power cable. Do not operate the appliance with a defective mains power cable.
- **WARNING:** Multiple sockets/distributors and other electronic equipment (such as halogen transformers) must not be placed or operated at the rear of the appliance.
- **WARNING:** Keep ventilation openings, in the appliance enclosure or in the built-in structure, clear of obstruction.
- Only customer service or other specially trained staff may repair or perform other operations on the appliance.
- Only assemble, connect and dispose of the appliance according to the instructions.

Fire hazard

- The coolant used (information on the model plate) is ecofriendly but also flammable. Any leaking coolant may ignite.
 - **WARNING:** Do not damage refrigeration circuit.
 - Do not handle ignition sources inside the appliance.
 - **WARNING:** Do not use electrical appliances in the fridge compartment which do not comply with the design recommended by the manufacturer.
 - If the refrigerant leaks: remove any naked flames or ignition sources from the vicinity of the leakage point. Properly air the room. Inform customer services.
- Do not operate the appliance close to explosive gases.
- Do not store or use petrol or other flammable gases and liquids close to the appliance.
- Do not store any explosive substances, such as aerosol containers with flammable propellant gas, in the appliance. To identify these spray cans, look for the list of contents printed on the can, or a flame symbol. Gases possibly escaping may ignite due to electrical components.
- Keep burning candles, lamps and other items with naked flames away from the appliance so that they do not set the appliance on fire.
- Please be sure to store alcoholic drinks or other packaging containing alcohol in tightly closed containers. Any alcohol that

Functionality of the Touch & Swipe display

leaks out may be ignited by electrical components.

Danger of tipping and falling:

- Do not misuse the plinth, drawers, doors etc. as a step or for support.

Danger of frostbite, numbness and pain:

- Avoid prolonged skin contact with cold surfaces or refrigerated/frozen goods or take protective measures, e.g. wear gloves.

Danger of injury and damage:

- **WARNING:** Do not use mechanical equipment or other methods to speed up the defrosting process other than those recommended by the manufacturer.
- **WARNING:** Risk of injury due to electric shock! There are live electrical parts under the cover.
Only have the LED interior lighting replaced or repaired by customer service or other suitably trained professionals.
- **NOTICE:** Appliance must only be used using original manufacturer accessories or using accessories from other providers approved by the manufacturer. The user bears the risk of using accessories which are not approved.

Risk of crushing

- Do not hold the hinge when opening and closing the door. Fingers may get caught.

Specialist personnel qualifications:

Specialist personnel are persons who, on account of their specialist training, knowledge and experience as well as their knowledge of the relevant standards, are able to assess and perform the work assigned to them and identify potential hazards. They must have training, instruction, and authorisation to work on the appliance.

Symbols on the appliance:



This symbol may be located on the compressor. It relates to the oil in the compressor and makes reference to the risk that: **Swallowing or inhaling can be fatal.** This advice is only relevant to recycling. There is no danger in normal operation.



WARNING: Danger of fire / flammable materials. This symbol is located on the compressor and indicates the danger of flammable materials. Do not remove the sticker.



This or a similar sticker may be located on the rear of the appliance. This sticker indicates that there are vacuum insulation panels (VIP) or perlite panels in the door and/or housing. This advice is only relevant to recycling. Do not remove the sticker.



WARNING: Cold surface! Only touch with suitable hand protection.

This or similar sticker may be on the appliance and indicates the danger of frostbite.

Please note the warning messages and other specific advice in the other chapters:

	DANGER	Indicates an immediately hazardous situation which will lead to death or serious injuries if it is not avoided.
	WARNING	Indicates a hazardous situation which will lead to death or serious injuries if it is not avoided.
	CAUTION	Indicates a hazardous situation which will lead to minor or moderate injuries if it is not avoided.
	NOTICE	Indicates a hazardous situation which may lead to damage to property if it is not avoided.
	Note	Indicates useful instructions and tips.

3 Functionality of the Touch & Swipe display





You operate your appliance using the Touch & Swipe display. You select appliance functions in the Touch & Swipe display (hereafter referred to as display) by tapping them. If you do not perform any action on the display for 10 seconds, the display either jumps back to the higher-level menu or directly to the status display.

3.1 Navigation and symbol explanation

In the illustrations, different symbols are used to navigate the display. The following table describes these symbols.

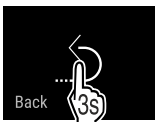
Symbol	Description
	Briefly touch the display: Activates/deactivates function. Confirms selection. Opens submenu.
	Touch the display for a specified time (e.g. 3 seconds): Activates/deactivates function or value.
	Swipe left or right: Navigate in the menu.

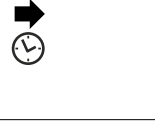
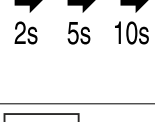
Functionality of the Touch & Swipe display

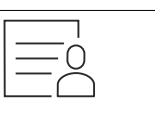

Symbol	Description
	Briefly touch the Back symbol: Jumps back one menu level.
	Press and hold the Back symbol for 3 seconds: Jumps back to the status display.
	Briefly touch the Back symbol at the top left: Jumps back one menu level.
	Arrow with clock: It takes more than 10 seconds for the following message to appear in the display.
	Arrow with a time indication: It takes the specified amount of time until the following message appears in the display.
	“Open Settings menu” symbol: Navigates to the Settings menu and opens the settings menu. If necessary: Navigate to the desired function in the Settings menu. (see 3.2.1 Opening the Settings menu)
	“Open Advanced menu” symbol: Navigates to the Advanced menu and opens the advanced menu. If necessary: Navigate to the desired function in the Advanced menu. (see 3.2.2 Opening the expanded menu)
No action for 10 seconds	If you do not perform any action on the display for 10 seconds, the display either jumps back to the higher-level menu or directly to the status display.
Open door and close it again.	If you open the door and immediately close it again, the display jumps directly back to the status display.

Note: Illustrations of the display are shown in the English version.

3.2 Menus

The appliance functions are distributed over various menus:

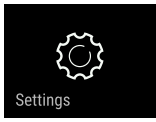
Menu	Description
Main menu	When you switch the appliance on, you are automatically in the main menu. From here you can navigate to the most important appliance functions, to the Settings menu and to the Advanced menu.

Menu	Description
 Settings menu	The Settings menu contains additional appliance functions for setting up your appliance.
 Advanced menu	The advanced menu contains special appliance functions for setting up your appliance. Access to the Advanced menu is protected by the numerical code 151 .

3.2.1 Opening the Settings menu

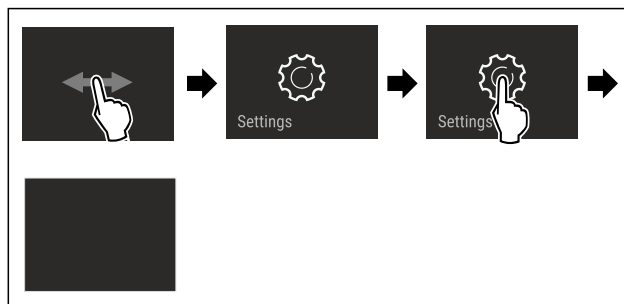

Fig. 5 Example illustration

- ▶ Carry out action steps according to the illustration.
- ▷ Settings menu is open.
- ▶ If necessary: Navigate to the desired function.

3.2.2 Opening the expanded menu

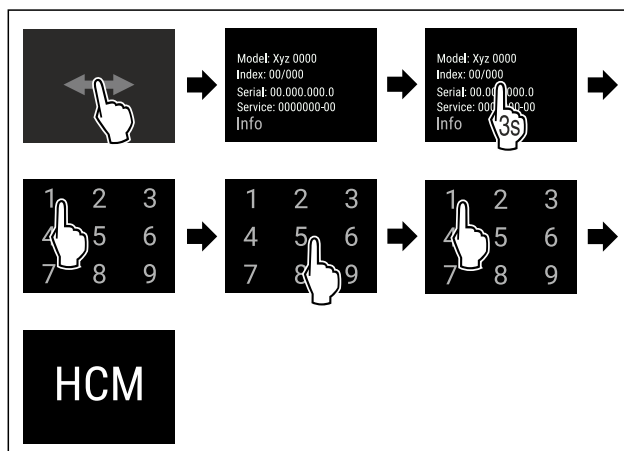

Fig. 6 Access with numerical code **151**

- ▶ Carry out action steps according to the illustration.
- ▷ The expanded menu is open.
- ▶ If necessary: Navigate to the desired function.

3.3 Sleep mode

If you do not touch the display for 1 minute, the display switches to sleep mode. In sleep mode, the display brightness is dimmed.

3.3.1 Ending sleep mode

- ▶ Touch the display briefly with your finger.
- ▷ Sleep mode is ended.

Putting into operation

4 Putting into operation

4.1 Installation conditions



WARNING

Fire hazard due to dampness!
If live parts or the mains lead become damp this may cause short circuits.

- ▶ The appliance is designed for use in enclosed areas. Do not operate the appliance outdoors or in areas where it is exposed to splash water or damp conditions.

4.1.1 Installation location



WARNING

Leaking coolant and oil!
Fire. The coolant contained in the appliance is eco-friendly, but also flammable. The oil contained in the appliance is flammable. Escaping coolant and oil can ignite if the concentration is high enough and in contact with an external heat source.

- ▶ Do not damage the pipelines of the coolant circuit and the compressor.

- Do not install appliance in direct sunlight, next to an oven, radiator or similar.
- The best place for installation is a dry and well ventilated room.
- If the appliance is installed in a very humid environment, condensation can form on the outside of the appliance. Always ensure good airflow and ventilation in the installation location.
- The more refrigerant there is in the appliance, the larger the space it is installed in must be. If the space is too small, any leak may create a flammable mixture of gas and air. For every 8 g of refrigerant, the installation space must be at least 1 m³. Information regarding the refrigerant can be found on the type plate inside the appliance.
- The floor of the location must be horizontal and even.
- The installation location must be able to withstand the weight of the appliance plus weight when stocked to maximum level. (see 9.1 Technical specifications)
- Use in hazardous areas is not permitted.

4.1.2 Electrical connection



WARNING

Danger of fire due to incorrect positioning!
If the mains cable or plug touches the back of the appliance, the vibration can damage the mains cable or the plug resulting in a short circuit.

- ▶ Make sure the mains cable is not trapped under the appliance when you position the appliance.
- ▶ Stand the appliance so that it is not touched by connectors or main cables.
- ▶ Do not connect any appliances to sockets in the area of the back of the appliance.
- ▶ Do **not** place and operate multi-sockets/power distributors and other electronic devices (such as halogen transformers) at the back of the appliances.

4.2 Appliance dimensions

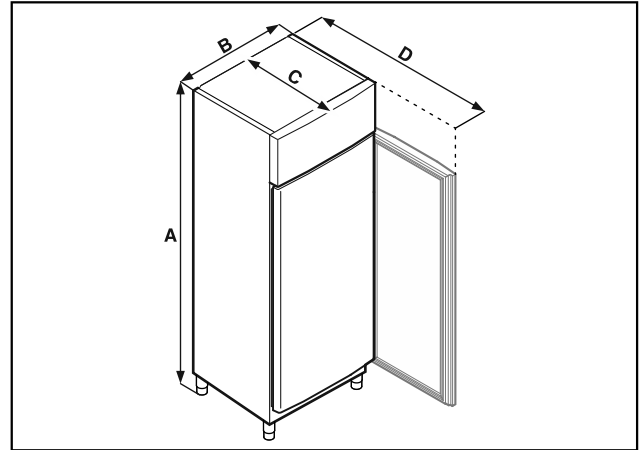

Fig. 7 Example illustration

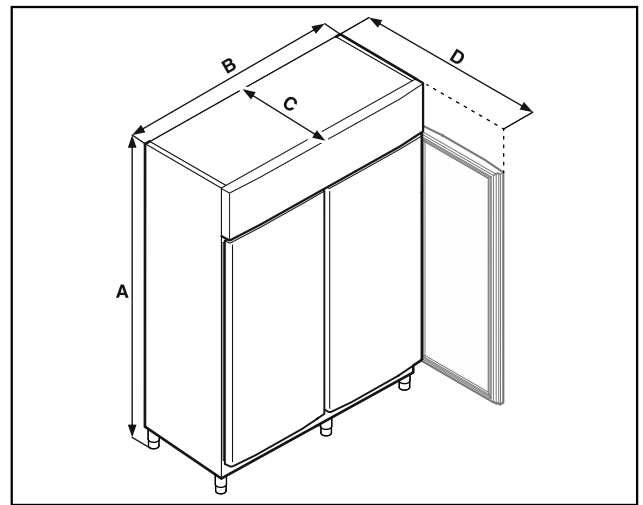

Fig. 8 Example illustration

	FFPSrh 1402	FFPSrh 6501
A	2115 mm	2115 mm
B	1427 mm	697 mm
C	867 mm	867 mm
D	1500 mm	1500 mm

A = appliance height including feet (minimum) / castors

B = appliance width without handle

C = appliance depth without handle

D = appliance depth with door open

4.3 Transporting appliance



DANGER

Risk of injury and damage due to heavy appliance!

- ▶ Always transport the appliance with at least two people.



DANGER

Risk of injury and damage due to the appliance tipping over!

- ▶ Pay attention to uneven floors and ramps when transporting appliances.

Note when transporting the appliance:

- ▶ Transport the appliance upright.

- ▶ If necessary: Dismantle two-door appliances for transport.

During first use:

- ▶ Transport the appliance packaged.

When transporting appliances after initial commissioning (e. g. moving or cleaning):

- ▶ Empty the appliance.
- ▶ Secure the door against unintentional opening.

4.4 Unpacking appliance

- ▶ Check the appliance and the packaging for damage during transport. Contact the supplier immediately if you suspect any damage. Do not connect appliance to the power supply.
- ▶ Remove all packaging materials from the rear or the side walls of the fridge that may prevent proper installation or prevent air flow and ventilation.

4.5 Connect power cable

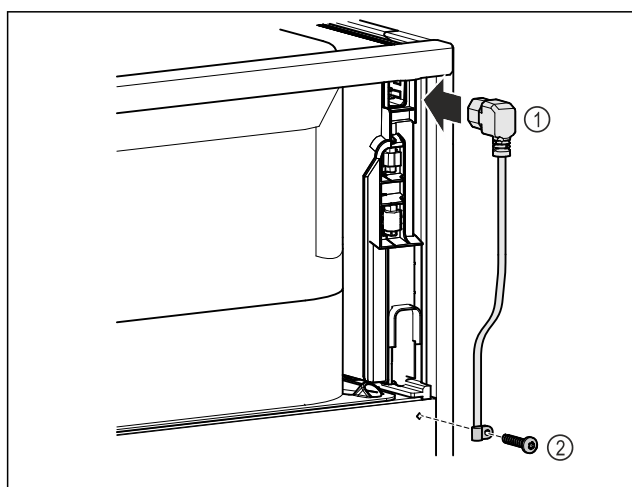

Fig. 9

- ▶ IEC socket of the power cable Fig. 9 (1) on the rear side of the appliance.
- ▶ Install mains tension relief. Fig. 9 (2)

4.6 Installing appliance



CAUTION

Risk of injury and damage.

- ▶ Use 2 people to install appliance.



CAUTION

Risk of injury and damage.

The door can knock against the wall and become damaged as a result. In the case of glass doors, the damaged glass can cause injuries.

- ▶ Protect the door from knocking against the wall. Attach door stopper, e.g. felt stopper, to the wall.

- ▶ Connect all necessary components (e.g. mains cable) to the back of the appliance and route to the side.

Note

Cables can be damaged.

- ▶ Do not jam the cable when pushing the appliance back.
- ▶ The spacing between the top edge of the device and the room ceiling must be at least 300 mm.

4.7 Setting up the appliance so it is level

NOTICE

Appliance body is deformed and door does not close.

- ▶ Align appliance horizontally and vertically.
- ▶ Compensate for uneven floors using adjustable feet.



WARNING

Incorrect height adjustment of the adjustable foot!

Can cause severe or even fatal injury. Incorrect height adjustment can cause the bottom part of the adjustable foot to come loose and the appliance to tip over.

- ▶ Do not unscrew the adjustable foot too far.

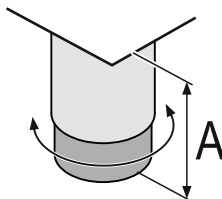

Fig. 10 The adjustable foot can be adjusted from $A = 115 \text{ mm}$ (4 1/2 in) to 175 mm (6 7/8 in).

Raising appliance:

- ▶ Turn adjustable foot clockwise.

Lowering appliance:

- ▶ Turn adjustable foot anticlockwise.

4.8 Installing multiple appliances

NOTICE

Risk of damage due to condensation between the side walls.

- ▶ Do not install the appliance directly next to another fridge.
- ▶ Install appliances with a space 3 cm between appliances.
- ▶ Only install multiple appliances up to temperatures of $35 \text{ }^\circ\text{C}$ and 65% humidity next to one another.
- ▶ At higher levels of humidity, increase space between appliances.

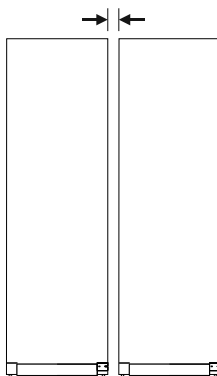

Fig. 11 Side-by-side installation

Note

A side-by-side kit is available as an accessory via Liebherr Customer Service. (see 9.3 Customer Service)

4.9 After installation

- ▶ Peel off the protective films. *
- ▶ Clean appliance. (see 8.2 Cleaning the appliance)
- ▶ If necessary: Disinfect the appliance.

Putting into operation

- ▶ Keep the invoice so you have the appliance and dealer information available if needed.

4.10 Disposing of packaging



WARNING

Danger of suffocation due to packing material and plastic film!

- ▶ Do not allow children to play with packing material.

The packaging is made of recyclable materials:

- corrugated board/cardboard
- expanded polystyrene parts
- polythene bags and sheets
- polypropylene straps
- nailed wooden frame with polyethylene panel*

- ▶ Take the packaging material to an official collecting point.

4.11 Reversing the door opening direction

Liebherr recommends:

- ▶ Have the door hinge reversed by a service technician.

4.12 Aligning the door

Liebherr recommends:

- ▶ Have the door aligned by a service technician.

4.13 Connecting appliance



WARNING

Danger of fire due to incorrect connection!
Burns.

Damage to the appliance.

- ▶ Do not use an extension cable.
- ▶ Do not use distributor blocks.

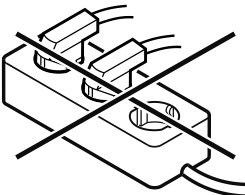

NOTICE

Danger of damage to incorrect connection!

Damage to the appliance.

- ▶ Do not connect the appliance to a stand-alone inverter, e.g. solar power systems and petrol generators.

Note

Only use the supplied mains cable.

Make sure that the following requirements are fulfilled:

- The appliance operated using **alternating current** only.
- The permitted voltage and frequency is printed on the type plate. The type plate position can be seen in the appliance overview chapter. (see 1.2 Overview of appliances and equipment)
- The socket is earthed according to the regulations and fused.
- The fuse tripping current is between 10 A and 16 A.
- The socket is easily accessible.

- ▶ Check the electrical connection.
- ▶ Insert the appliance plug into the back of the appliance. Ensure that they latch into place.
- ▶ Connect the mains plug to the power supply.
- ▷ The display switches to the standby symbol.

4.14 Switching on appliance (first use)

Make sure that the following requirements are fulfilled:

- Appliance is installed and connected.
- All adhesive strips, adhesive and protective films and transport locks are removed from inside and outside the appliance.

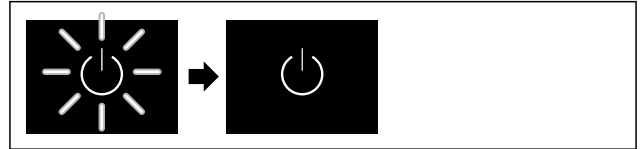

Fig. 12 Example illustration

The standby symbol flashes until the startup process is complete.

The standby symbol is shown in the display.

If the appliance has been supplied with factory settings, the screen language and the date/time first need to be set when using the appliance for the first time.

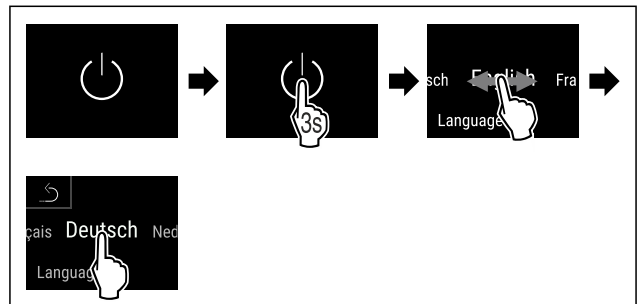

Fig. 13

- ▶ Carry out action steps according to the illustration.
- ▷ Language is set.

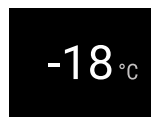

Fig. 14 Status display

- ▷ The appliance is ready for operation once the temperature appears in the display.
- ▷ The temperature display flashes until the set temperature is reached.

4.15 Using equipment

4.15.1 Inserting the snap strips

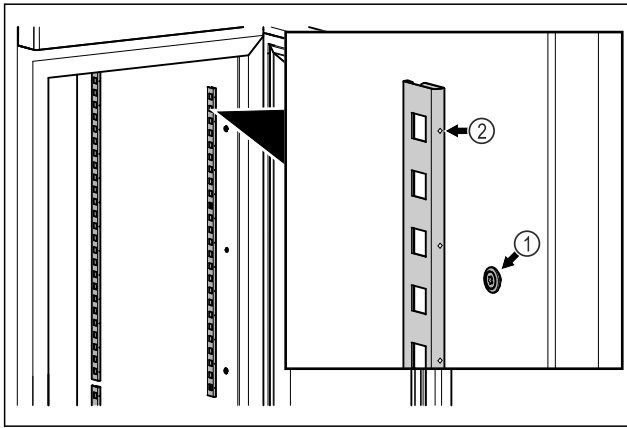

Fig. 15 Example illustration

- ▶ Hook the snap strips into the suspension Fig. 15 (1). Mark Fig. 15 (2) must point forwards.

4.15.2 Inserting support rail

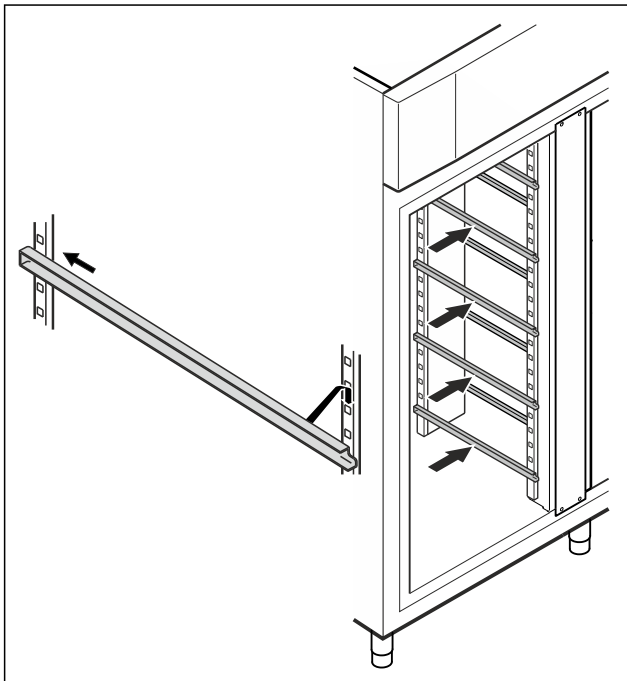

Fig. 16 Example illustration

- ▶ Insert support rail into rear snap-in bar and attach at front.

4.16 Centre grid shelf

4.16.1 Inserting centre grid shelf

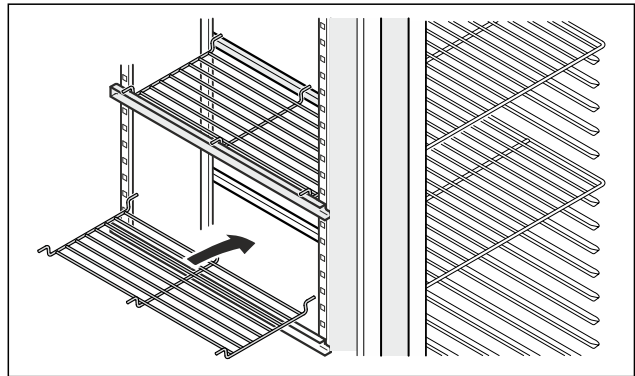

Fig. 17 Example illustration

- ▶ Place centre grid shelf on to support rails.

5 Storage

5.1 Information regarding storage

Note

Failure to follow these guidelines can lead to food becoming spoiled.

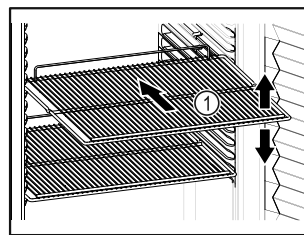



Fig. 18 Example illustration

When stocking observe the following:

- If there are adjustable shelves Fig. 18 (1), position them as required.
- Observe maximum load weight. (see 9.1 Technical specifications)
- Do not load appliance until storage temperature has been reached (maintain cold chain).
- Refrigerated goods must not touch the rear wall.
- Do not store refrigerated goods beyond the rear stop of the support grates.
- Keep liquids in closed containers.
- Package raw meat or fish in clean, closed containers. This will prevent meat or fish from touching or dripping onto other food.
- Leave space when storing items for refrigeration to ensure good air circulation.
- Do not stack refrigerated products above the indicated height.  This is important for free air circulation and even temperature distribution in the interior.

5.2 Storage times

The best-before date specified on the packaging should be used as the reference point for the storage time.

6 Controls

6.1 Control and display elements

The display provides a quick overview of the current appliance status, the temperature setting, the status of functions and settings as well as alarm and error messages.

It is operated by swiping or pressing the colour touch display directly.

Functions can be activated or deactivated and setting values can be changed.



Fig. 19 Colour touch display

(1) Status display

6.1.1 Status display

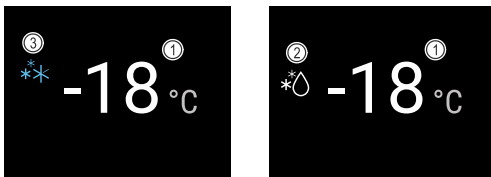

Fig. 20 Status display

(1) Temperature

(2) Defrosting status

(3) SuperFrost status

The status display is the home display.

It displays the temperature in the centre and three symbols in the lower area. The status display may show a further range of display symbols.

You navigate from the status display to the functions and settings.

6.1.2 Display symbols

Display symbols provide information about the status of the appliance.

Symbol	Appliance status
	Standby symbol Appliance is switched off.
	Standby (flashing) symbol Appliance is starting up.

Symbol	Appliance status
	Temperature (flashing) Target temperature not yet reached. Appliance cooling to temperature set.
	Temperature display Appliance displays the set temperature.
	D in the display Appliance is in Demo-Mode.
	Maintenance display (yellow) The time interval set has expired.
	Full data memory (yellow) The data memory (999 hours) is full. From now, the oldest data will be overwritten.
	Error symbol (red) Appliance is in error state.
	Back arrow Leads to higher-level menu.
	Background (blue) Active setting or active function
	Bar (increasing) Press for 3 seconds to activate setting.
	Bar (decreasing) Press for 3 seconds to deactivate setting.

Status display symbols

6.1.3 Acoustic signals

A signal sounds in the following cases:

- If a function or a value is confirmed.
- If a function or a value can either not be activated or not deactivated.
- As soon as an error occurs.
- If there is an alarm message.

The alarms can be switched on and off in the customer menu.

6.2 Appliance functions

6.2.1 Notes on the appliance functions

The appliance functions are set at the factory so that your appliance is fully functional.

Before you alter, activate or deactivate the device functions, make sure that the following requirements are met:

- ❑ You have read and understood the descriptions of how the display works. (see 3 Functionality of the Touch & Swipe display)
- ❑ You have familiarised yourself with the operating and display elements of your appliance. (see 6.1 Control and display elements)

6.2.2 Switching appliance on and off



This function makes it possible to switch the entire appliance on and off.

Switching on appliance

Without activated DemoMode:

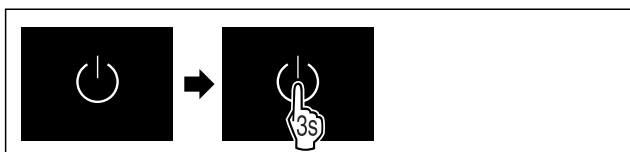

Fig. 21

- ▶ Carry out action steps according to the illustration.

With activated DemoMode:

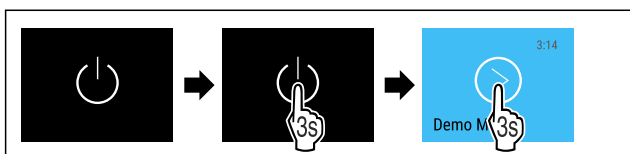

Fig. 22

- ▶ Carry out action steps according to the illustration.

Note

Deactivate DemoMode before countdown finishes.

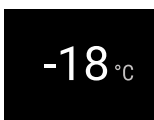

Fig. 23 Status display

- ▷ The temperature appears in the display.

Switching off appliance

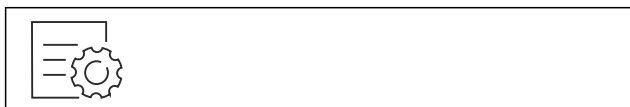

Fig. 24

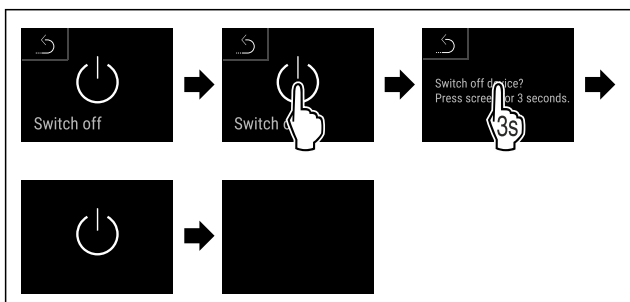

Fig. 25

- ▶ Carry out action steps according to the illustration.
- ▷ Standby symbol is shown in the display.
- ▷ Display switches off after approximately 10 minutes.



6.2.3 Temperature

The temperature depends on the following factors:

- How often the door is opened
- How long the door is open for
- The room temperature of the installation site
- The type, temperature and amount of food

Note

The temperature may differ from the temperature displayed in some areas of the interior.

At the correct temperature, frozen food will keep for longer. This avoids disposing of food unnecessarily.

Setting temperature

The following steps describe how to lower the temperature, e.g. from -18 °C to -28 °C.



Fig. 26

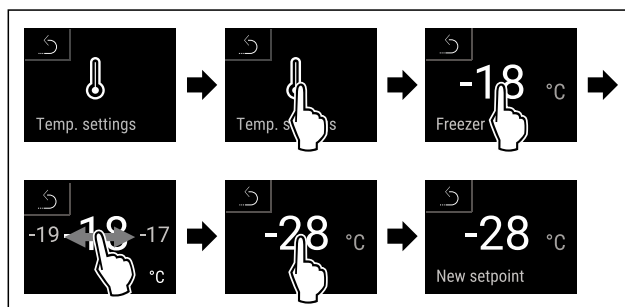

Fig. 27

- ▶ Carry out action steps according to the illustration.
- ▷ Temperature is set.

6.2.4 Temperature recording



The appliance displays the minimum and maximum temperatures of the interior via this function. The recording of these temperatures starts automatically after the appliance is switched on; they are recorded at one minute intervals. A note indicating that the data memory is full is displayed after 999 hours (approx. 40 days). The temperature recording should then be reset.

Note

The temperature recording should be reset once **after reaching the set temperature** when the appliance is commissioned. (see Resetting temperature recording) This ensures that the value for the maximum temperature is a meaningful value.

Displaying temperature recording

The temperature recording displays the length of the recording and the minimum and maximum temperatures measured during this period of time.



Controls

Fig. 28

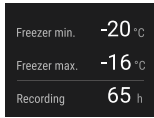

Fig. 29

▷ Status screen with the temperature recordings is displayed.

Resetting temperature recording

The displayed minimum and maximum temperatures can be reset at any time. This deletes the displayed values and the recording interval starts again.

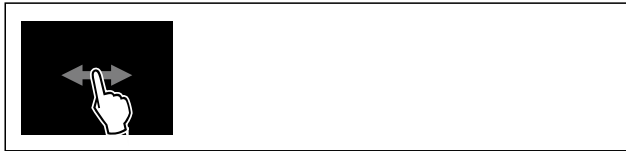

Fig. 30

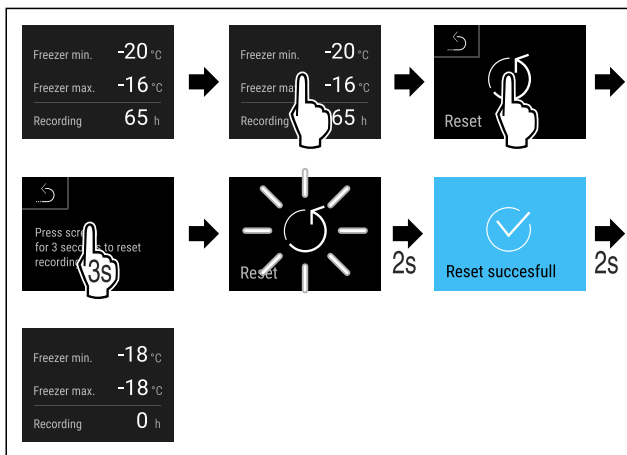

Fig. 31

▶ Carry out action steps according to the illustration.
▷ Temperature recording is reset.

6.2.5 Lighting



The appliance is fitted with interior lighting. When you open the appliance door, the interior lighting switches on. You can also deactivate this function.

6.2.6 Presentation light



This setting allows the presentation light to be adjusted incrementally.

The following brightness values can be set:

- Off
- 20%
- 40%
- 60%
- 80%
- 100% (default)

Adjusting the presentation light

The following steps describe how to reduce the brightness of the presentation light, e.g. from 100 % to 40 %.

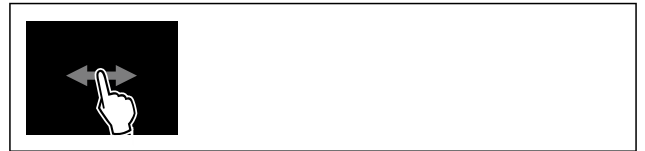

Fig. 32

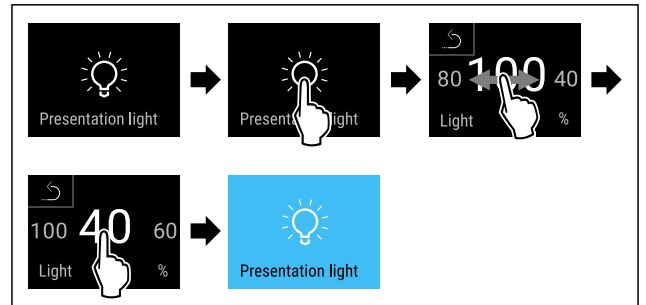

Fig. 33

▶ Carry out action steps according to the illustration.
▷ The brightness of the presentation light changes accordingly.

6.2.7 SuperFrost



You can use this function to activate or deactivate SuperFrost. If SuperFrost is activated, then the appliance increases the freezing capacity. It allows you to achieve lower freezing temperatures.

Application:

- Quickly freeze fresh food through to the core. This ensures that the nutrition, appearance and taste of frozen food is maintained.
- Increase the cold reserve in stored frozen food before defrosting the appliance.

If the function is active, the appliance operates at higher power. As a result, the appliance's operating noise may be temporarily louder and energy consumption will increase.

Activating SuperFrost



Fig. 34

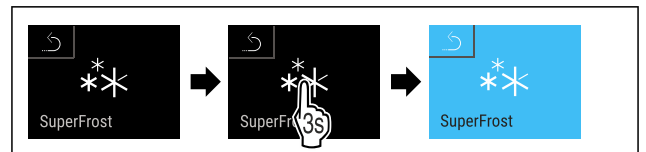

Fig. 35

▶ Carry out action steps according to the illustration.
▷ SuperFrost is activated.
▷ Status display shows SuperFrost symbol.

Deactivating SuperFrost

SuperFrost is automatically deactivated after 8 to 65 hours depending on the quantity of the food inserted. However, you can also deactivate SuperFrost manually at any time:



Fig. 36



Fig. 37

- ▶ Carry out action steps according to the illustration.
- ▷ SuperFrost is deactivated.
- ▷ The appliance continues to run in normal mode.
- ▷ The appliance cools to the temperature set previously.

6.2.8 Display lock



This setting avoids accidental operation of the appliance.

Application:

- Prevent settings and functions being changed unintentionally.
- Prevent the appliance being switched off unintentionally.
- Prevent temperature being set unintentionally.

Activating display lock



Fig. 38

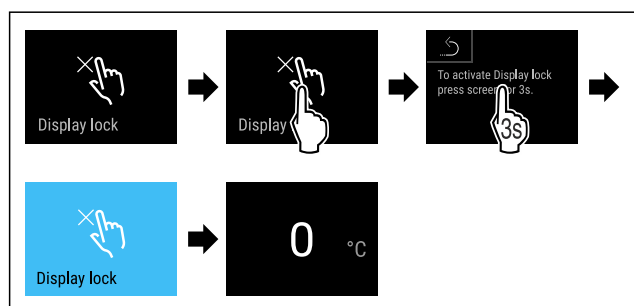

Fig. 39

- ▶ Carry out action steps according to the illustration.
- ▷ The display lock is activated.
- ▷ The status display appears.

Deactivating display lock

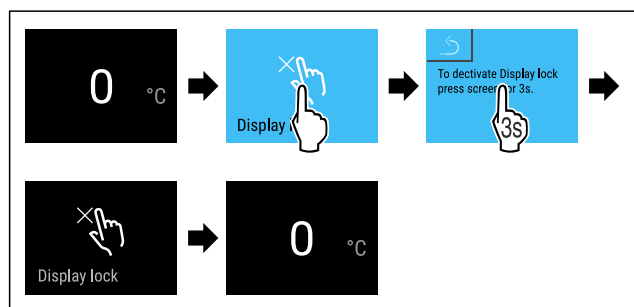

Fig. 40

- ▶ Carry out action steps according to the illustration.
- ▷ The display lock is deactivated.
- ▷ The status display appears.

6.2.9 Access codes

Various settings are possible.

Application:

- Changing the display lock code. *
- Resetting the display lock code. *

6.2.10 Maintenance interval reminder



Setting for the time interval after which a maintenance reminder is issued.

The following values can be set:

- 7 days
- 14 days
- 30 days
- 60 days
- 90 days
- 180 days
- 360 days
- 720 days
- 1080 days
- Off

Setting maintenance interval reminder

The following steps describe how the maintenance interval is set.



Fig. 41

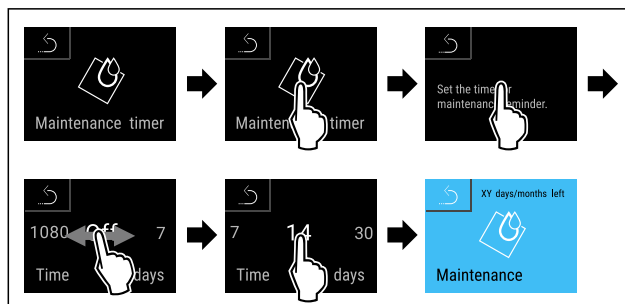

Fig. 42

- ▶ Carry out action steps according to the illustration.
- ▷ The time interval, after which the maintenance reminder is issued, is set.
- ▷ The remaining time is displayed.

6.2.11 Language



This setting allows the display language to be set.

Setting language



Fig. 43

Controls

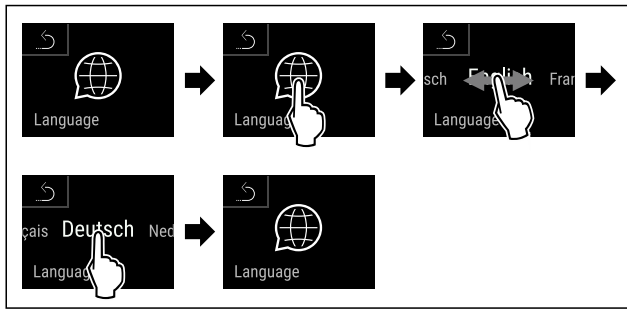

Fig. 44

- ▶ Carry out action steps according to the illustration.
- ▷ The selected language is set.



6.2.12 Temperature unit

Use this function to set the temperature unit. You can set degrees Celsius or degrees Fahrenheit as the temperature unit.

Setting the temperature unit

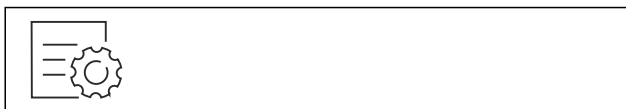

Fig. 45

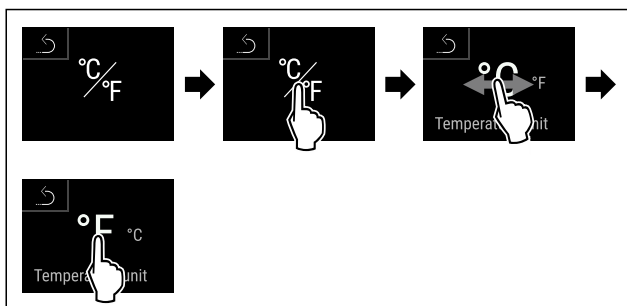

Fig. 46 Example illustration: Switch from degrees Celsius to degrees Fahrenheit.

- ▶ Carry out action steps according to the illustration.
- ▷ The temperature unit is set.



6.2.13 WiFi connection

Note

Liebherr SmartMonitoring Dashboard is not available in all countries. Check availability via the QR code by entering your model.

Note

Use of the Liebherr SmartMonitoring Dashboard at <https://smartmonitoring.liebherr.com> requires installation of a SmartModule and a commercial MyLiebherr account. When commissioning online you can register using the login data you have, or register again and create a company account.

This setting establishes a wireless connection between the appliance and the internet. The connection is controlled via the SmartModule. The appliance can be integrated via the browser-based [Liebherr SmartMonitoring Dashboard](#) and advanced options as well as customised methods relating to control, administration and monitoring can be used.

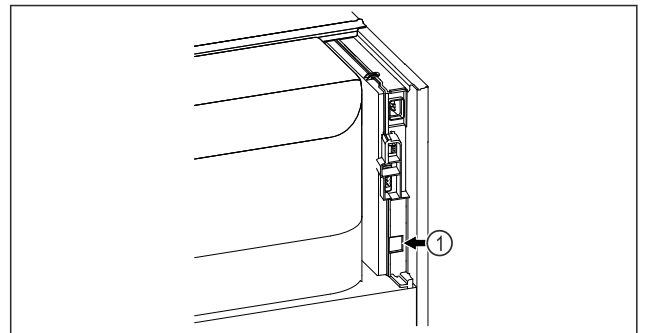

Fig. 47

Make sure that the following requirements are fulfilled:

- SmartModule Fig. 47 (1) is in use.

Establishing connection

You commission and set up your SmartModule online via the [Liebherr SmartMonitoring Dashboard](#) on your web-enabled device.



Fig. 48

- ▶ Open [Liebherr SmartMonitoring Dashboard](#). (see Fig. 48)
- On the refrigerator or freezer:



Fig. 49



Fig. 50

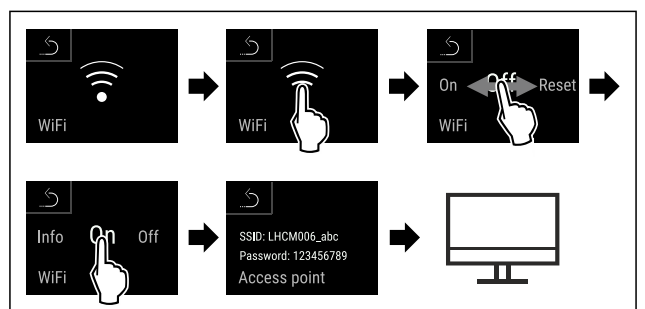

Fig. 51

- ▶ Carry out action steps according to the illustration.
- ▶ Continue the set-up procedure on your web-enabled device: [Liebherr SmartMonitoring Dashboard](#)

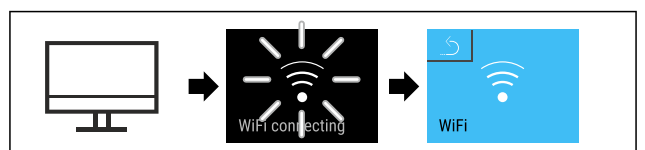

Fig. 52

- ▶ Carry out action steps according to the illustration.
- ▷ Connection is established: WiFi connecting appears. The symbol flashes.

- ▶ Follow the [Liebherr SmartMonitoring Dashboard](#) instructions.
- ▷ Connection is established.

Disconnecting



Fig. 53



Fig. 54

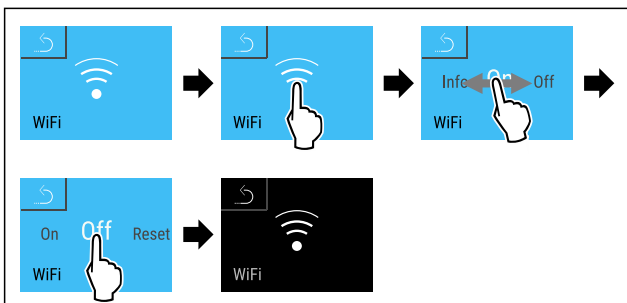

Fig. 55

- ▶ Carry out action steps according to the illustration.
- ▷ There is no connection.

Resetting connection



Fig. 56



Fig. 57

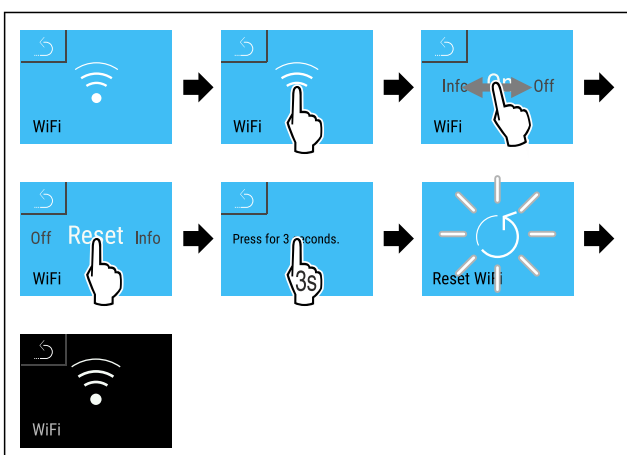

Fig. 58

- ▶ Carry out action steps according to the illustration.
- ▷ The WiFi settings are restored to the factory settings.

6.2.14 LAN connection



Note

Liebherr SmartMonitoring Dashboard is not available in all countries. Check availability via the QR code by entering your model.

Note

Use of the Liebherr SmartMonitoring Dashboard at <https://smartmonitoring.liebherr.com> requires installation of a SmartModule and a commercial MyLiebherr account. When commissioning online you can register using the login data you have, or register again and create a company account.

This setting establishes a wired connection between the appliance and the internet. The connection is controlled via the SmartModule. The appliance can be integrated via the browser-based [Liebherr SmartMonitoring Dashboard](#) and advanced options as well as customised methods relating to control, administration and monitoring can be used.

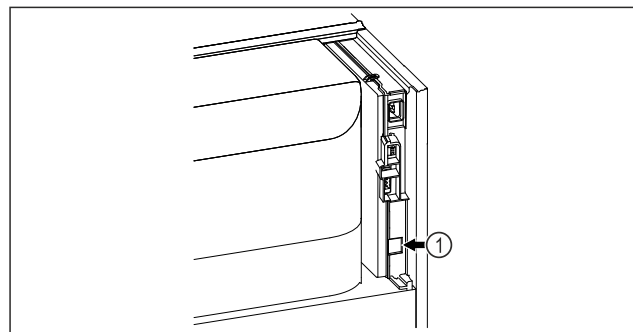

Fig. 59

Make sure that the following requirements are fulfilled:

- SmartModule Fig. 59 (1) is in use.
- A network cable is connected.

Establishing connection

You commission and set up your SmartModule online via the [Liebherr SmartMonitoring Dashboard](#) on your web-enabled device.



Fig. 60

- ▶ Open [Liebherr SmartMonitoring Dashboard](#). (see Fig. 60)
- On the refrigerator or freezer:



Fig. 61

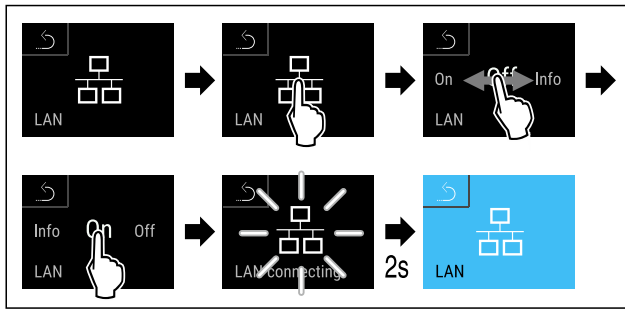

Fig. 62

- ▶ Carry out action steps according to the illustration.
- ▷ Connection is established: LAN connecting appears. The symbol flashes.
- ▶ Follow the [Liebherr SmartMonitoring Dashboard](#) instructions.
- ▷ Connection is established.

Disconnecting



Fig. 63

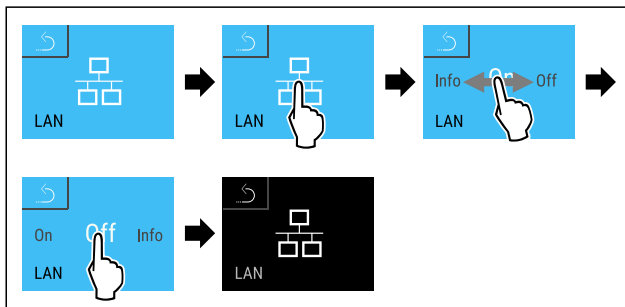

Fig. 64

- ▶ Carry out action steps according to the illustration.
- ▷ There is no connection.

6.2.15 Device information

Use this function to indicate the model name, index, serial number and service number of your device. You will need the device information when you contact customer service. (see 9.3 Customer Service)

This function also opens the Advanced menu. (see 3 Functionality of the Touch & Swipe display)

Indicating the device information



Fig. 65



Fig. 66

- ▶ Carry out action steps according to the illustration.
- ▷ Display indicates device information.



6.2.16 Operating hours

The display shows the appliance operating hours.

Displaying operating hours



Fig. 67



Fig. 68

- ▷ The operating hours appear.

6.2.17 Software

Use this function to indicate the software version of your device.

Indicating the software version



Fig. 69

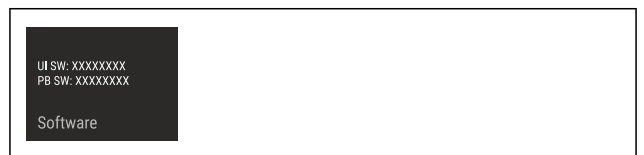

Fig. 70

- ▶ Carry out action steps according to the illustration.
- ▷ Display indicates software version.



6.2.18 Defrosting

The appliance defrosts automatically in normal mode.

Application:

- If there is excessive ice in the interior, the defrosting function can be started manually.

Manually starting automatic defrosting



Fig. 71



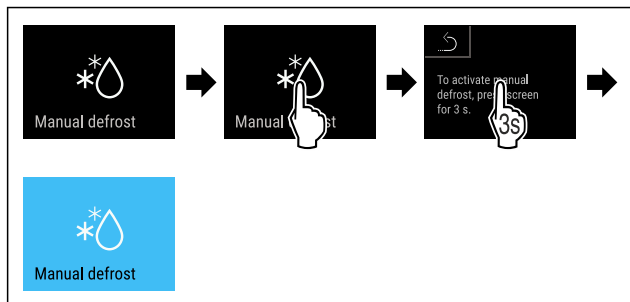

Fig. 72

- ▶ Carry out action steps according to the illustration.
- ▷ Automatic defrosting has been started. The appliance automatically switches back to normal mode once defrosting has finished.

Note

If there is still ice in the interior after starting automatic defrosting several times, defrost the appliance manually. (see 8.1 Defrosting appliance)

Cancelling manually started defrosting



Fig. 73

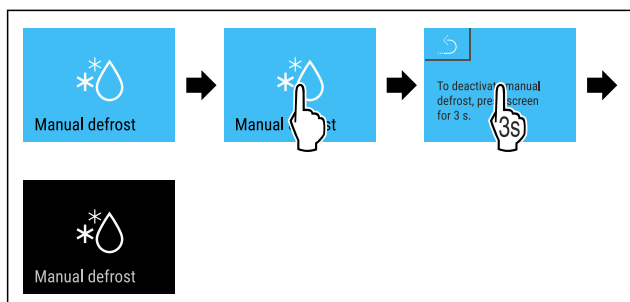

Fig. 74

- ▶ Carry out action steps according to the illustration.
- ▷ Manually started defrosting is cancelled. The appliance automatically switches back to normal mode.

6.2.19 Door alarm



Use this function to activate or deactivate the door alarm. The door alarm sounds if the door is open for too long. The door alarm is activated on delivery. You can set how long the door may be open before the door alarm sounds.

The following values can be set:

- 15 seconds
- 30 seconds
- 60 seconds
- 90 seconds
- 120 seconds
- 150 seconds
- 180 seconds
- Off

Setting the door alarm

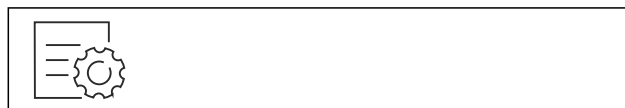

Fig. 75

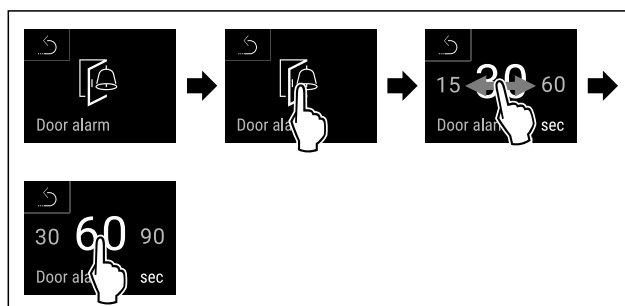

Fig. 77 Example illustration: Switch door alarm from 30 seconds to 60 seconds.

- ▶ Carry out action steps according to the illustration.
- ▷ The door alarm is set.

Deactivating the door alarm



Fig. 78

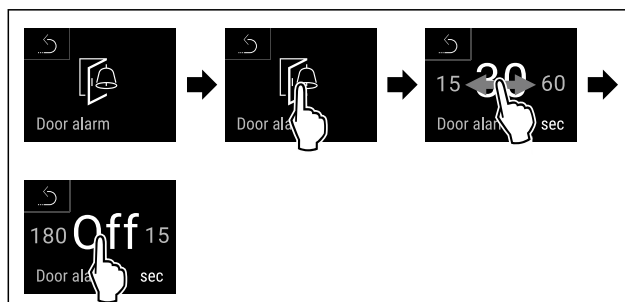

Fig. 79

- ▶ Carry out action steps according to the illustration.
- ▷ The door alarm is deactivated.

6.2.20 Light alarm



This setting allows the visual alarm messages in the display to also be emphasised by flashing appliance lighting.

Activating light alarm



Fig. 80



Fig. 81

- ▶ Carry out action steps according to the illustration.
- ▷ The light alarm is activated.

Controls

Deactivating light alarm



Fig. 82



Fig. 83

- ▶ Carry out action steps according to the illustration.
- ▷ The light alarm is activated.



6.2.21 Demo mode

Demo mode is a special feature for dealers who want to demonstrate appliance features. If you activate demo mode, all refrigeration functions are deactivated.

If you switch on your appliance and a “D” appears on the status display, demo mode is already activated.

If you activate and then deactivate demo mode, the appliance will be reset to factory defaults. (see 6.2.22 Resetting to factory settings)

Activating demo mode

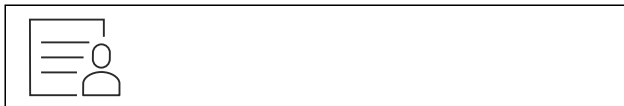

Fig. 84

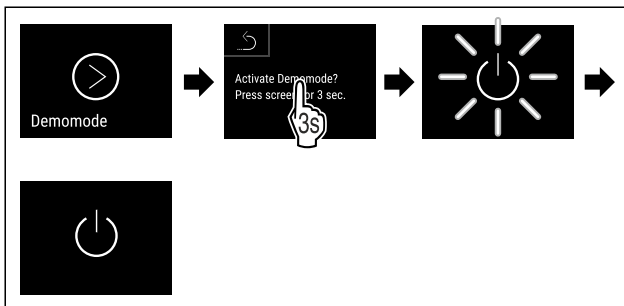

Fig. 85

- ▶ Carry out action steps according to the illustration.
- ▷ Demo mode is activated.
- ▷ Appliance is switched off.
- ▶ Switch on the appliance. (see 4.14 Switching on appliance (first use))
- ▷ “D” appears in the status display.

Deactivating demo mode

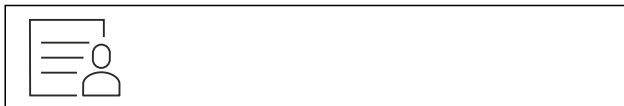

Fig. 86

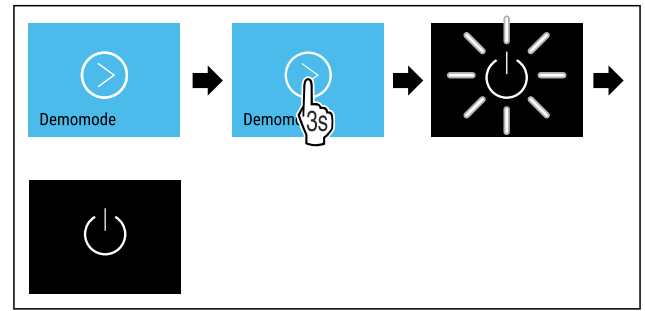

Fig. 87

- ▶ Carry out action steps according to the illustration.
- ▷ Demo mode is deactivated.
- ▷ Appliance is switched off.
- ▶ Switch on the appliance. (see 4.14 Switching on appliance (first use))
- ▷ Appliance is reset to factory settings.



6.2.22 Resetting to factory settings

Use this function to reset all settings to factory defaults. All settings you have made so far are reset to their original settings.

Performing a reset



Fig. 88

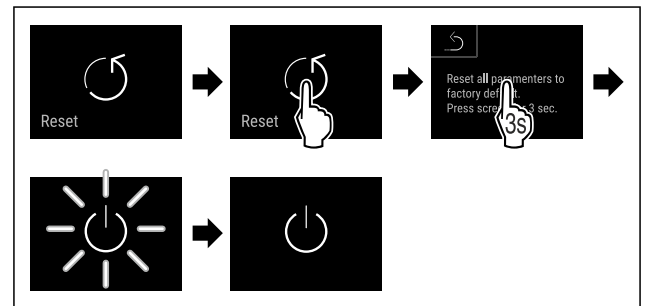

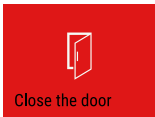



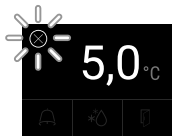

Fig. 89

- ▶ Carry out action steps according to the illustration.
- ▷ Device is reset.
- ▷ Device is switched off.
- ▶ Restart the device. (see 4.14 Switching on appliance (first use))



6.3 Message

6.3.1 Warnings

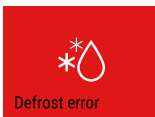
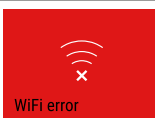
Warnings are issued by means of an acoustic signal and visually via a symbol on the display. The signal gets louder until the warning is acknowledged.

Message (red)	Cause	Remedy
 <p>Close the door</p> <p>Door open</p>	<p>This message appears if the door is open for too long.</p>	<p>Close the door.</p> <p>Tap briefly.</p> <p>Alarm is stopped.</p> <p>Note</p> <p>The time until the message appears can be set. (see 6.2.19 Door alarm)</p>
 <p>Temperature alarm</p> <p>Temperature alarm</p>	<p>This message appears if the temperature does not match the set temperature. Reasons for differences in temperature can be:</p> <p>Warm produce for cooling has been placed inside.</p> <p>Too much warm air has got in while you were sorting out the freezer or removing items.</p> <p>The power was cut off for a prolonged period.</p>	<p>Tap briefly.</p> <p>Information about errors and appliance status are displayed.</p> <p>Tap briefly.</p> <p>Warmest/coldest temperature, date and time are displayed.</p> <p>Tap briefly.</p> <p>The status screen is displayed.</p> <p>The current temperature and the alarm symbol flash red until the set temperature is reached.</p> <p>Check the quality of the refrigerated goods.</p>
 <p>Device failure</p> <p>Error</p>	<p>The appliance is faulty, there is an appliance error or a component of the appliance has a fault.</p>	<p>Store the cooled produce elsewhere.</p> <p>Tap briefly.</p> <p>The error code (e.g. BT021) is displayed.</p> <p>Tap briefly.</p> <p>A further error code is displayed if there is one</p> <p>or</p> <p>Status screen is displayed with flashing error symbol.</p> <p>Swiping or tapping the display will show the error code(s) again.</p> <p>Make a note of error code(s) and contact Customer Service. (see 9.3 Customer Service)</p>  
 <p>Power failure</p> <p>Power cut</p>	<p>The message appears following an interruption to the electricity supply.</p>	<p>Tap briefly.</p> <p>Battery's state of charge, information about errors and appliance status are displayed</p> <p>Tap briefly.</p> <p>Highest temperature, time period and number of electricity supply interruptions are displayed.</p> <p>Tap briefly.</p> <p>The status screen is displayed.</p> <p>The current temperature and the alarm symbol flash red until the set temperature is reached.</p> <p>Check the quality of the refrigerated goods.</p>
 <p>Defrost error</p> <p>Defrost error</p>	<p>The automatic defrosting is not working properly. The previous five defrost cycles were not successful.</p>	<p>Press briefly.</p> <p>Alarm is stopped.</p> <p>Contact Customer Service. (see 9.3 Customer Service)</p>
 <p>WiFi error</p> <p>WiFi error</p>	<p>Wi-Fi connection is interrupted.</p>	<p>Check connection.</p> <p>Press briefly.</p> <p>Alarm is stopped.</p>

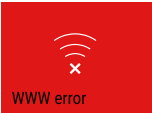
Features

Message (red)	Cause	Remedy
 <p>WWW error, WiFi</p>	This message appears if there is no internet connection via WiFi.	Check connection. Press briefly. Alarm is stopped.
 <p>LAN error</p>	LAN connection is interrupted.	Check connection and network cable. Press briefly. Alarm is stopped.
 <p>WWW error, LAN</p>	This message appears if there is no internet connection via LAN.	Check connection. Press briefly. Alarm is stopped.

6.3.2 Reminders

Reminders appear when you are being asked to do something. They are issued by means of an acoustic signal and visually via a symbol on the display. Acknowledge the message by pressing the confirmation button.

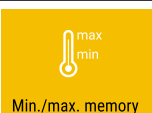
Message (yellow)	Cause	Remedy
 <p>Maintenance reminder</p>	The message appears when the timer for the set maintenance interval has expired.	Press briefly. Reminder is closed. Note The maintenance interval can be set (see 6.2.10 Maintenance interval reminder).
 <p>Recording reminder</p>	The message appears when the temperature recording memory (999 hours) is full.	Press briefly. Reminder is closed. The oldest data is overwritten. Note The temperature recording can be reset. (see 6.2.4 Temperature recording)

7 Features

7.1 Safety lock

The lock in the appliance door is equipped with a safety mechanism.

7.1.1 Locking appliance

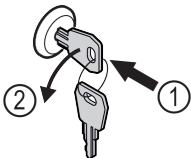

Fig. 90

- ▶ Insert key.
- ▶ Turn key anticlockwise by 90°.
- ▷ The appliance is locked.

7.1.2 Unlocking appliance

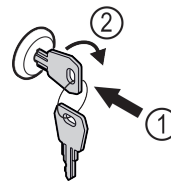

Fig. 91

- ▶ Insert key Fig. 91 (1).
- ▶ Turn key clockwise by 90° Fig. 91 (2).
- ▷ The appliance is unlocked.

8 Maintenance

8.1 Defrosting appliance



WARNING

Improper defrosting of the appliance!
Injuries and damage.

- ▶ Do not use mechanical equipment or other methods to speed up the defrosting process other than those recommended by the manufacturer.
- ▶ Do not use electrical heating or steam-cleaning appliances, naked flames or defroster sprays to defrost.
- ▶ Do not use sharp objects to remove ice.

To maintain the functionality of the appliance, we recommend defrosting it when there is a high buildup of ice. Icing in the interior is determined by the location (e.g. high humidity), settings on the appliance and incorrect user behaviour.

Manual defrosting:

- ▶ Switch off appliance. (see 6.2.2 Switching appliance on and off)
- ▶ Pull out mains plug.
- ▶ Store refrigerated items elsewhere.
- ▶ Leave appliance door open during defrosting process.
- ▶ Absorb any remaining defrost water with a cloth and clean the appliance.

8.2 Cleaning the appliance

8.2.1 Preparing



WARNING

Short-circuit hazard due to live parts!
Electric shock or damage to the electronics.

- ▶ **Switch off the appliance.**
- ▶ Pull out mains plug or switch off fuse.



WARNING

Risk of fire

- ▶ Do not damage the refrigeration circuit.

- ▶ Empty the appliance.
- ▶ Pull out the mains plug.
- ▶ Observe the notes on transporting the appliance. (see 4.3 Transporting appliance)

8.2.2 Cleaning housing

NOTICE

Improper cleaning!
Damage to the appliance.

- ▶ Only use soft cleaning cloths and ph-neutral all-purpose cleaners.
- ▶ Do not use abrasive sponges or steel wool which may cause scratches.
- ▶ Do not use any sharp or abrasive cleaning agents, nor any that contain sand, chloride or acid.



WARNING

Risk of injury and damage as a result of hot steam!
Hot steam can lead to burns and can damage the surfaces.

- ▶ Do not use any steam cleaners!

NOTICE

Risk of damage due to short circuit.

- ▶ When cleaning the appliance, make sure no water gets into the electrical components.

- ▶ Wipe the housing down with soft, clean cloth. If very dirty, use lukewarm water with a neutral cleaner. Glass surfaces can also be cleaned with glass cleaner.
- ▶ Clean condenser coil each year. If the condenser coil is not cleaned, this significantly reduces the efficiency of the appliance.

8.2.3 Cleaning interior



WARNING

Short-circuit hazard due to live parts!
Electric shock or damage to the electronics.

- ▶ **Switch off the appliance.**
- ▶ Pull out mains plug or switch off fuse.



WARNING

Risk of injury and damage as a result of hot steam!
Hot steam can lead to burns and can damage the surfaces.

- ▶ Do not use any steam cleaners!

NOTICE

Improper cleaning!
Damage to the appliance.

- ▶ Only use soft cleaning cloths and ph-neutral all-purpose cleaners.
- ▶ Do not use abrasive sponges or steel wool which may cause scratches.
- ▶ Do not use any sharp or abrasive cleaning agents, nor any that contain sand, chloride or acid.

Note

Do not damage or remove the type plate on the inside of the appliance. The type plate is important for Customer Service. (see 9.3 Customer Service)

- ▶ Open the door.
- ▶ Empty the appliance.
- ▶ Clean interior and equipment parts with lukewarm water and a little detergent. Do not use any gritty or acidic cleaning agent or any chemical solvent.

8.2.4 After cleaning

- ▶ Wipe appliance and equipment parts dry.
- ▶ Connect and switch on appliance.
Once the temperature is sufficiently cold:
- ▶ put in items for refrigeration goods.
- ▶ Repeat cleaning regularly.
- ▶ Clean and dust refrigerators with a heat exchanger (metal grille on the rear of the appliance) once per year.

9 Customer help

9.1 Technical specifications

Temperature range	
Freezing	-9 °C to -26 °C

Customer help

Maximum load of grid shelves ^{A)}	Maximum load of centre grid shelf ^{A)} (see 4.15 Using equipment)
60 kg	10 kg

A) Heavier loads may result in a slight bending of the shelves.

Maximum net capacity
See net capacity on the type plate. (see 1.2 Overview of appliances and equipment)

Lighting	
Energy efficiency class ^{A)}	Light source
This product contains one or more energy efficiency class G light sources	LED

A) The appliance may contain light sources with different energy efficiency classes. The lowest energy efficiency class is indicated.

WLAN frequency specification	
Frequency band	2.4 GHz
Maximum radiated power	<100 mW
Purpose of the wireless equipment	Integration in the local WiFi network for data communication

9.2 Technical fault

Your appliance is designed and built to ensure it works reliably and has a long service life. In the unlikely event that a fault occurs during operation, please check whether the fault is due to an operating error. If this is the case, you will be charged for the cost incurred even if this falls within the warranty period.

You can fix the following faults yourself.

9.2.1 Appliance function

Defect	Cause	Remedy
The appliance is not working.	→ The appliance is not switched on.	▶ Switch on the appliance.
	→ The mains plug is not properly plugged into the socket.	▶ Check the mains plug.
	→ There is something wrong with the fuse in the socket.	▶ Check fuse.
	→ Power cut	▶ Keep the appliance closed. ▶ Protect food: Lay cold storage accumulator on top of the food or use another freezer if the power is off for a prolonged period. ▶ Do not re-freeze defrosted food.
	→ The appliance plug is not properly inserted in the appliance.	▶ Check appliance plug.
Temperature is not cold enough.	→ The appliance door is not closed properly.	▶ Close appliance door.
	→ Ventilation is not sufficient.	▶ Clear ventilation grille and clean it.
	→ The ambient temperature is too high.	▶ Ensure the correct ambient conditions: (see 1.4 Range of use of appliance)
	→ The appliance was opened too many times or for too long.	▶ Wait to see if the appliance goes back to the required temperature by itself. If not, contact Customer Service. (see 9.3 Customer Service)
	→ The temperature is set incorrectly.	▶ Set a colder temperature and check after 24 hours.
	→ The appliance is too close to a heat source (oven, radiator, etc).	▶ Change where the appliance or the heat source are located.

9.3 Customer Service

First check whether you can remedy the fault yourself. If this is not the case, please contact Customer Service.

You can find the address in the enclosed brochure "Liebherr-Service" or at home.liebherr.com/service.



WARNING

Unprofessional repair!

Injuries.

- ▶ Have any repairs and action - not expressly specified - on the appliance and mains cable carried out by service personnel only. (see 8 Maintenance)
- ▶ A damaged mains cable may only be replaced by the manufacturer, the manufacturer's Customer Service or a similarly qualified person.
- ▶ In the case of appliances with an IEC connector, the change may be made by the customer.

9.3.1 Contacting Customer Service

Make sure you have the following appliance data at the ready:

- Appliance name (model and index)
- Service no. (Service)
- Serial no. (S no.)
- ▶ Access the appliance information via the display (see 6.2.15 Device information).
- or-
- ▶ Refer to the type plate for appliance information. (see 9.4 Type plate)
- ▶ Note down appliance information.
- ▶ Inform Customer Service: Report faults and the appliance information.
- ▷ This will help us to provide a fast and focussed service.
- ▶ Follow any further instructions provided by Customer Service.

9.4 Type plate

The type plate is inside the appliance. See appliance overview.

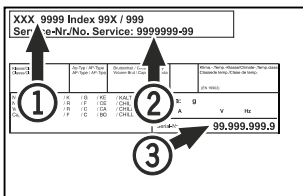

Fig. 92

- (1) Appliance designation (3) Serial No.
(2) Service No.

10 Shutting down

- ▶ Empty the appliance.
- ▶ Switch off the appliance.
- ▶ Pull out the mains plug.
- ▶ Remove appliance connector if required: remove and at the same time move from left to right.
- ▶ Clean appliance (see 8.2 Cleaning the appliance) .
- ▶ If present: Remove covers and insulation from the sensor feed-through to prevent mould forming.
- ▶ Leave the door open so that no bad odours form.

Note

Damage to the appliance and malfunctions!

- ▶ After shutting down, only store the appliance at the permitted room temperature of between -10 °C and +50 °C.

11 Disposal

11.1 Preparing appliance for disposal



Liebherr uses batteries in some of its appliances. In the EU, for environmental reasons, legislation obliges the end user to remove these batteries before disposing of old appliances. If your appliance contains batteries, a corresponding notice is attached.

Lamps If you can remove the lamps yourself without destroying them, also remove these before disposal.

- ▶ Take the appliance out of operation.

- ▶ Appliances with batteries: remove the batteries. For description, see **Maintenance** chapter.
- ▶ If possible: remove lamps without destroying them.

11.2 Disposing of the appliance in an environmentally friendly manner



The appliance still contains valuable materials and must be disposed of separately from unsorted municipal waste.



Li-Ion

Dispose of batteries separately from the old appliance. To do this, you can return the batteries free of charge to retailers as well as recycling centres and collection centres for recyclable materials.

Lamps

Dispose of removed lamps via the respective collection systems.

For Germany:

You can dispose of the appliance free of charge via the class 1 collection containers at the local recycling and recyclable material collection centres. When purchasing a new fridge/freezer, if the sales area > 400 m², retailers will also take back the old appliance free of charge.



WARNING

Leaking coolant and oil!

Fire. The coolant contained in the appliance is eco-friendly, but also flammable. The oil contained in the appliance is flammable. Escaping coolant and oil can ignite if the concentration is high enough and in contact with an external heat source.

- ▶ Do not damage the pipelines of the coolant circuit and the compressor.

- ▶ Observe the notes on transporting the appliance. (see 4.3 Transporting appliance)
- ▶ Transport the appliance without damaging it.
- ▶ Dispose of batteries, lamps and the appliance according to the above specifications.

12 Additional information

Further information on warranty conditions can be found in the enclosed service brochure or on the Internet at <https://home.liebherr.com>.



home.liebherr.com/fridge-manuals

EN Freezer
ORIGINAL OPERATOR'S MANUAL

Issue date: 20240424

Part number index: 7082998-00

Liebherr-Hausgeräte GmbH
Memminger Straße 77-79
88416 Ochsenhausen
Deutschland