



The Storage Choice
For Wine Aficionados

Quality, Design and Innovation

WKgb 4113

LIEBHERR



Recessed door handle: The WKgb 4113, with its elegantly designed recessed door handle, looks perfect in any home or restaurant. Meanwhile its insulated full-black glass door protects fine wines against UV radiation.



LED lighting: The integrated LED lighting in the wine cabinet interior ensures pleasant illumination and an optimum glance at your wine collection.

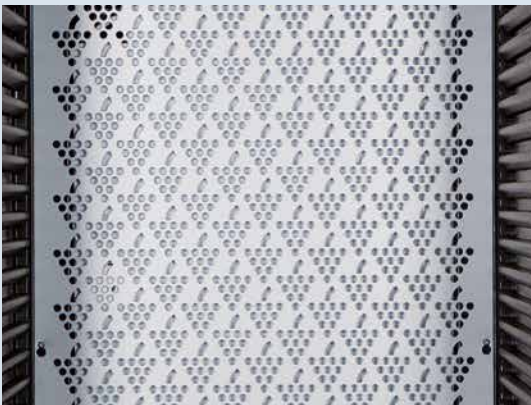

Optimum humidity: Liebherr wine cabinets guarantee an optimum humidity and this ensured the corks are supple in place whilst still allowing the wine to breathe in its maturing process.

Note: Whilst every effort is made to ensure all specifications and information in this flyer are accurate, Liebherr reserves the right to make changes without notification. Where actual appliance measurements, specifications, and ratings are crucial, we recommend that the actual appliance installation instructions that accompany each appliance be checked. Liebherr will not be liable for any loss.

The Barrique **WKgb 4113** wine cabinet provides climatic conditions similar to that of a wine cellar and is perfect for the long-term storage or maturing of fine wines. Interior temperature can be adjusted between +5°C to + 20°C. Our integrated activated carbon filter absorbs odours from the ambient air and prevents the taste of your wines from being impaired.

Additionally, the insulated full-black glass door also provides protection from UV radiation and preserves the quality of wine. With its elegantly designed recessed handle, this wine cabinet looks perfect in any home or restaurant. For added flexibility, optional accessories¹ are available for your selection.

WKgb 4113	
Barrique	LED Wine
°Energy consumption (kWh/yr) 24hr °178 0.487	
Bottle capacity (750ml Bordeaux)	168
Safety glass door	•
Control system Display	Buttons Digital
Digital temperature display	External
Tinted glazed door	Double
Temperature zones	1
Temperature range (°C) Min Max °C	5 20
Suitable for ambient temperature Min Max°C	16 43
Interior light	Vertical LED
Beech wood shelves	5
Presentation shelf Base shelves	Integrated 1
Recirculated air cooling Fresh air supply via activated charcoal filter	• 1
Child proof lock (control panel)	•
Handle design	Recessed
Key lock Label holders	• Optional extra
Temp alarm Door open warning signal	• •
Door hinge	Right, Fix
Gross weight (kg) Net weight (kg)	86 78
Voltage (V) Rated Current (A)	220-240 1.0
Made In	Malaysia

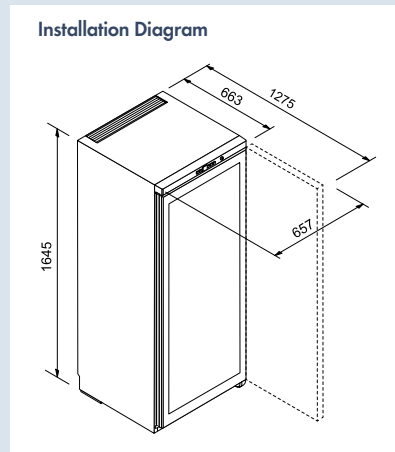

Activated Charcoal Filter
Part no.: 3988129100

° = Measurements taken at +25°C ambient and +12°C interior temperature tested by Liebherr Germany (not to Australian standards).

¹ Optional accessories: Presentation Shelf (Part no. 3711173600), Activated Charcoal Filter (Part no: 3988129100)