

Operating instructions

Countertop freezer

Read the operating instructions before switching on for the first time.

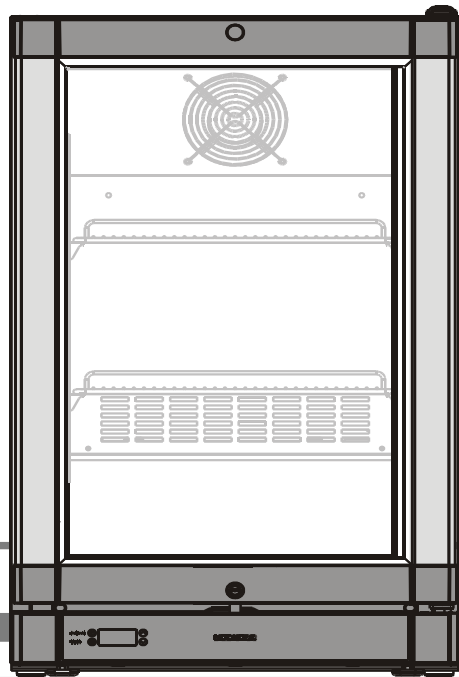

708 4914-00

Fv 913

LIEBHERR

Safety instructions and warnings

- **CAUTION:** This appliance is not intended for use by persons (including children) with reduced physical, sensory or mental capabilities or lack of experience and knowledge, unless they have been given supervision or instruction concerning use of the appliance by a person responsible for their safety.
- **CAUTION:** Children should be supervised to ensure that they do not play with the appliance.
- **CAUTION:** Maximum loading for each shelf is 30kg only!
- **WARNING:** If the supply cord is damaged, it must be replaced by the manufacturer, its service agent or similarly qualified persons in order to avoid a hazard.
- **CAUTION:** Do not store explosives substances such as aerosol cans with flammable propellant in this appliance.
- **CAUTION:** The appliance contains flammable materials and should be handled, serviced and disposed of properly.
- **WARNING:** Keep clear of obstruction all ventilation openings in the appliance enclosure or in the structure for building-in.
- **WARNING:** Do not use any mechanical devices or other artificial aids for defrosting other than those recommended by the manufacturer.
- **WARNING:** Do not damage the refrigerant circuit.
- **WARNING:** Do not use electrical appliances inside the food storage compartments of the appliance, unless they are of the type recommended by the manufacturer.
- This appliance can be used by children of 8 years and above, and also by persons with reduced physical, sensory or mental capabilities or lack of experience and knowledge, if they are supervised or have been instructed on safe use of the appliance and understand the resulting risks. Children must not allow to play with the appliance. Cleaning and user maintenance must not be carried out by children without supervision.
- To prevent injury or damage to the unit, the appliance should be unpacked and set up by two people.
- In the event that the appliance is damaged on delivery, contact the supplier immediately before connecting to the mains.
- To guarantee safe operation, ensure that the appliance is set up and connected as described in these operating instructions.
- Disconnect the appliance from the mains if any fault occurs. Pull out the plug, switch off or remove the fuse.
- When disconnecting the appliance, pull on the plug, not on the cable.
- Any repairs and work on the appliance should only be carried out by the customer service department, as unauthorised work could prove highly dangerous for the user. The same applies to changing the mains power cable.
- Do not allow naked flames or ignition sources to enter the appliance. When transporting and cleaning the appliance ensure that the refrigerant circuit is not damaged. In the event of damage, make sure that there are no ignition sources nearby and keep the room well ventilated.
- Do not stand on the plinth, drawers or doors or use them to support anything else.
- Avoid prolonged skin contact with cold surfaces or chilled/frozen food. This could cause pain, numbness and frostbite. In the case of prolonged skin contact, protective measures should be taken, e.g. gloves should be worn.
- Do not consume food which has been stored for too long, as it could cause food poisoning.
- Electrical components might cause leaking gas to ignite. You may identify such sprays by the printed or a flame symbol.
- If you have a lockable appliance, do not keep the key near the appliance or within reach of children.
- The appliance is designed for use in enclosed areas. Do not operate the appliance outdoors or in areas where it is exposed to splash water or damp conditions.
- When transporting or operating the appliance at an altitude of more than 1500 m above sea level, the glass pane in the door can break due to the reduction in air pressure. Broken fragments are sharp-edged and can cause serious injury.

Range of appliance use

The appliance is suitable solely for cooling food in a domestic environment or similar. This includes, for example, use

- In staff kitchenettes, bed and breakfast establishments,
- By guests in cottages, hotels, motels and other forms of accommodation,
- In catering and similar services in the wholesale trade.

Use the appliance solely as is customary within a domestic environment. All other types of use are inadmissible. The appliance is not suitable for storing and cooling medicines, blood plasma, laboratory preparation or similar substances and products covered by the 2007/47/EC Medical Devices Directive. Any misuse of the appliance may result in damage to or spoilage of the stored goods. Furthermore, the appliance is not suitable for operation in potentially explosive atmospheres.

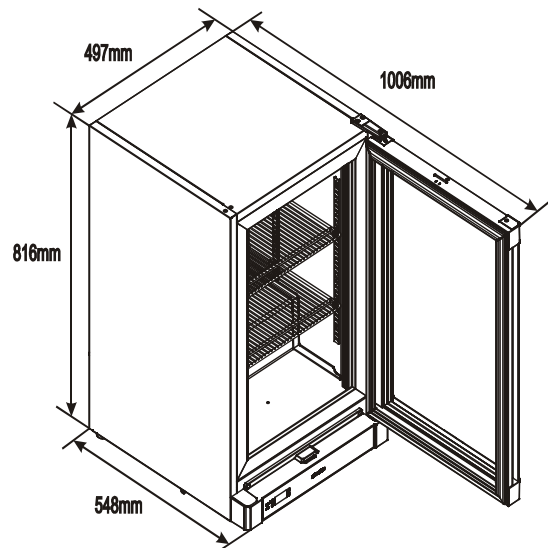

Dimensions:

Height : 816 mm Width : 497 mm Depth : 548 mm

Description of the appliance

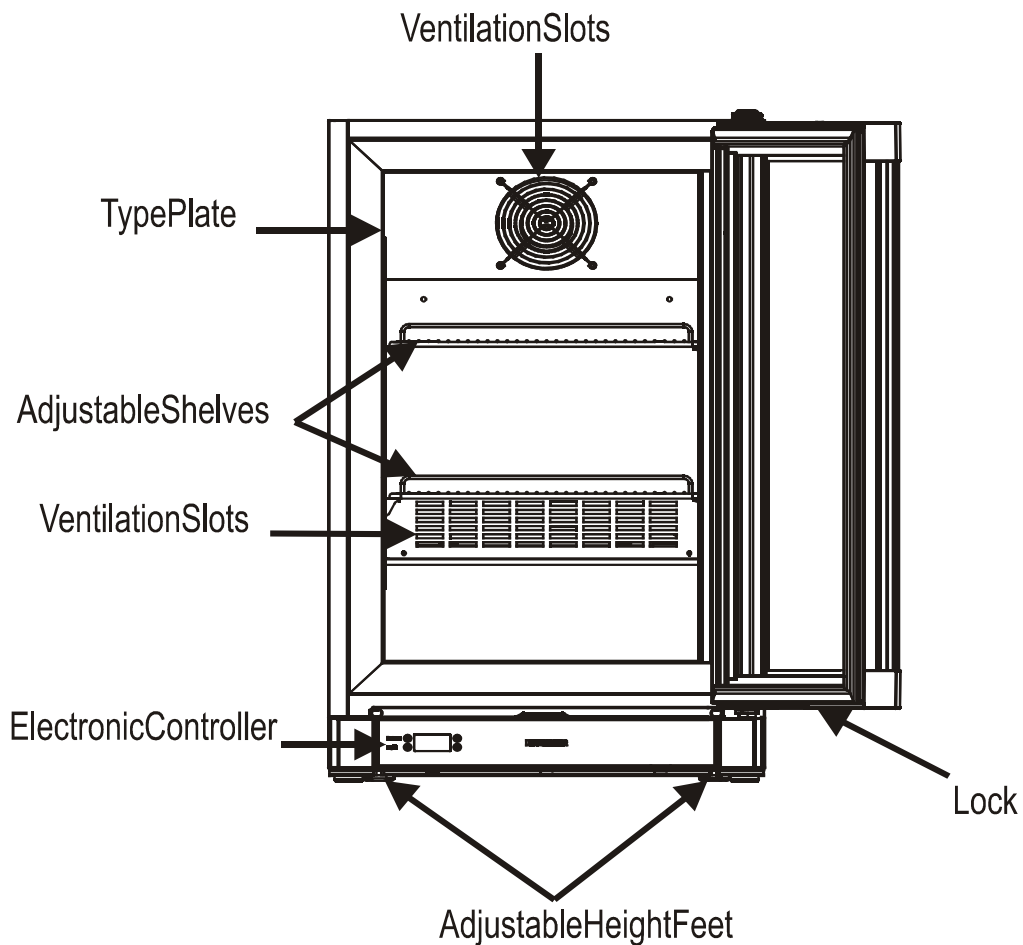

Climate rating

The climate rating indicates the room temperature at which the appliance may be operated in order to achieve full refrigeration performance.

The climate rating is indicated on the type plate.

The position of the type plate is shown in the section entitled Description of the appliance.



Climate rating	Room temperature
0	20°C
3	25°C
4	30°C
7	35°C

Do not operate the appliance outside the specified room temperature range.

Setting up

- Do not place the appliance in direct sunlight or near cookers, radiators and similar sources of heat.
- The floor on which the appliance stands should be horizontal and level. Compensate for uneven floors with the adjustable feet. 
- ATTENTION:** There must be a gap of at least 10 cm between the side enclosure (left and right) and rear enclosure of the appliance against the wall.
- Always ensure there is good ventilation and that the outward flowing air is able to escape. Always install the appliance directly against the wall.
- Do not cover ventilation openings or grille.
- Standard EN 378 specifies that the room in which you install your appliance must have a volume of 1 m³ per 8 g of R 600a / R 290 refrigerant used in the appliance, so as to avoid the formation of inflammable gas/air mixtures in the room where the appliance is located in the event of a leak in the refrigerant circuit. The quantity of refrigerant used in your appliance is indicated on the type plate on the inside of the appliance.

Electrical connection

Only operate the appliance with alternating current (AC).

The permissible voltage and frequency are indicated on the type plate. The position of the type plate is shown in the section entitled Description of the appliance.

The socket must be properly earthed and protected by a fuse.

The tripping current of the fuse must be between 10 A and 16 A.

The socket must not be situated behind the appliance and must be easily accessible.

Do not connect the appliance using an extension cable or extension socket.

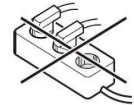

Do not use stand-alone inverters (conversion of direct current to alternating current / three phase current) or energy-saving plugs. Risk of damage to the electronic control system!

Switch the appliance on and off

You are recommended to clean the appliance before switching it on for the first time (see Cleaning).

To switch the appliance on

Connect the appliance to the mains - the appliance is switched on.

To switch the appliance off

Pull out the mains plug - the appliance is switched off.

Operating elements

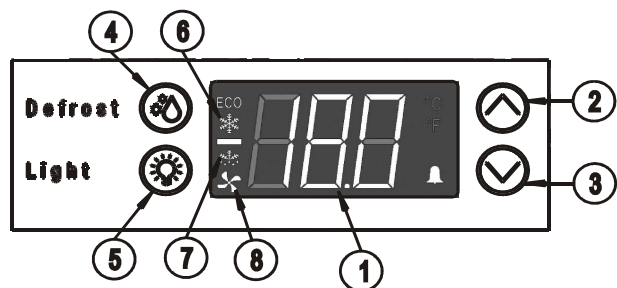



- Temperature display
- Up button
- Down button
- Defrost button
- Light button
- Compressor running symbol
- Defrost running symbol
- Evaporator fan running symbol

Note :

During the cooling system is in defrost mode, the operating noise changes, and no cooling takes place.

Setting the temperature

- Press the UP  button to increase the temperature.
- Press the DOWN  button to reduce the temperature.
- The temperature can be set between $-10^{\circ}\text{C} \sim -25^{\circ}\text{C}$ / $+14^{\circ}\text{F} \sim -13^{\circ}\text{F}$.
- The display will blink for few times and the set temperature will be saved once it stop blinking.

Interior light

LED lighting is used for interior.

- The interior light can be turned on and off using the button 5





Important :

The lighting may only be replaced by the customer service technician or by competent skilled personnel!

Caution - class 1M laser radiation. When cover is removed, do not look directly at light through optical instruments.

Defrosting

The refrigerator compartment defrosts automatically.

- Defrosts also can be manually activated by pressing the  button and the defrost signed 'dEF' (picture 1)  appears on temperature display.



Manual defrosts should not be done during the first 2 hours of operation.

Do not use any mechanical devices or other artificial aids for defrosting other than those recommended by the manufacturer.

Cleaning

Cleaning the appliance at least twice per year.

Before cleaning always switch off the appliance. Pull out the mains plug or switch off.

- Clean the inside, equipment and outer walls with lukewarm water and a little detergent. Do not use abrasive or acid cleaners or chemical solvents.
- Ensure that no cleaning water penetrates into the electrical components or ventilation grille.
- The dust should be removed from the refrigeration unit and heat exchanger - metal grid at the back of the appliance once a year.
- Do not damage or remove the type plate on the inside of the appliance. It is very important for servicing purposes.

Do not use steam cleaners because of the risk of injury and damage.

Cooling

The grid shelves can be moved to accommodate different height bottles or packages.

High-percentage alcohols should be tightly sealed and stored upright.

Do not cover the ventilation slots inside the appliance.

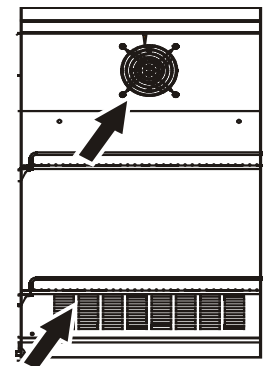

Brightness Control

To adjust the brightness of the LED strips:

- Insert something (coin, screwdriver etc) into knob slot.
- Turn clockwise for brighter illumination.
- Turn anti-clockwise for dimmer illumination.

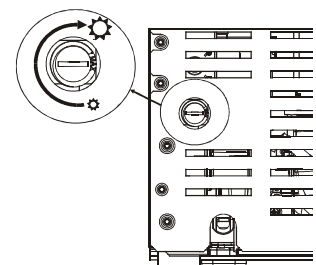

Note: Only applicable for appliance with dimmer

Safety lock

The lock is equipped with a safety mechanism.

Locking the appliance:

1. Insert the key.
2. Push and turn the key 90° counterclockwise

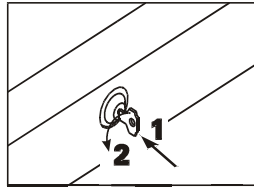

To unlock the appliance, the same procedure must be repeated in the same order.

Shutting your appliance down

If your appliance is to be shut down for any length of time, switch it off by disconnect the plug or unscrew the fuse.

Clean the appliance and leave the door open in order to prevent unpleasant smells.

The appliance complies with the relevant safety regulations and EC Directives 2004/108/EC and 2006/95/EC.

Disposal notes

The appliance contains reusable materials and should be disposed of properly - not simply with unsorted household refuse. Appliance which are no longer needed must be disposed of in a professional and appropriate way, in accordance with the current local regulations and laws.

When disposing of the appliance, ensure that the refrigerant circuit is not damaged to prevent uncontrolled escape of the refrigerant it contains (data on type plate) and oil.

- Disable the appliance.
- Pull out the mains plug.
- Cut through the connection cable.

Malfunctions

If a malfunction occurs during operation, check whether it is due to an operating error.

You may be able to rectify the following faults yourself:

Appliance does not function:

- Is the appliance switched on?
- Is the plug correctly fitted in the mains socket?
- Is the fuse intact?

Loud running noise:

- Is the appliance set up firmly on the floor?
- Does the appliance cause nearby items of furniture or objects to vibrate? Please note that noises caused by the refrigerant circuit cannot be avoided.

The temperature is not low enough:

- Is the temperature setting correct (see "Setting the temperature")?
- Have the excessive amounts of fresh food been placed in the appliance?
- Does the separately installed thermometer show the correct reading?
- Is the ventilation system working properly?
- Is the appliance set up too close to a heat source?

If none of the above causes apply and you cannot rectify the fault yourself, contact the nearest customer service department stating the type designation (1), service number (2) and appliance number (3) as indicated on the type plate. The position of the type plate is shown in the section entitled Description of the appliance.

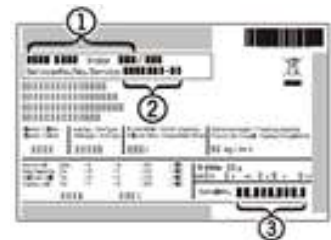

WARNING

Danger of suffocation due to packing material and plastic film!