

LIEBHERR

Use and Care Manual for Refrigerator

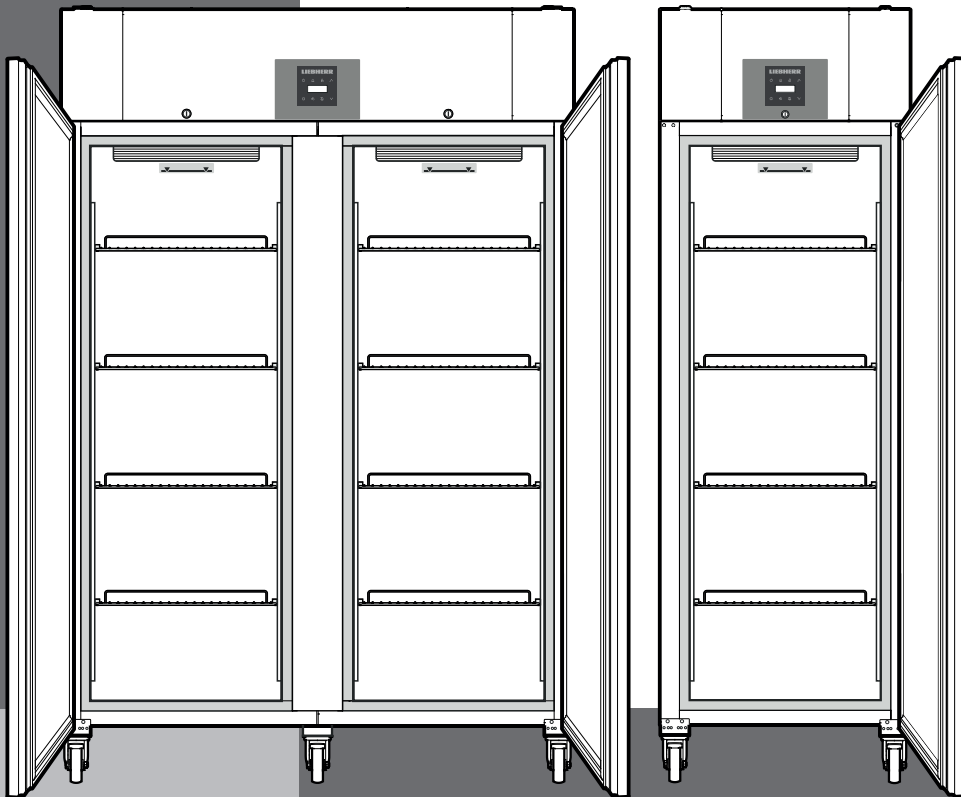

LRT50W2HC
LRT30W1HC
7084 011-02

TABLE OF CONTENTS

Table of Contents	Page
Please Read and Follow these Instructions.....	2
California Proposition 65	2
Disposal of Old Appliance	3
Disposal of this Appliance	3
Disposal of Batteries.....	3
Disposal of Carton	3
R290 Refrigerant	3
Important Safety Information	4
Electrical Safety	4
Blocking for Safety.....	4
Safety Regulations.....	5
External Alarm Outputs	5
Setting Up	5
Supplied Equipment	5
Installing the Equipment	6
Castors.....	6
Dimensions	7
Description of the Appliance	7
Back-up Battery	8
Operating and Control Elements.....	8
Switching the Appliance On and Off	9
Setting the Temperature	9
Door Open Alarm.....	9
Setting the Delay Time for the Door Open Alarm	9
Audible Alarm Settings	10
Deactivating the Audible Alarm Function.....	10
Alarm Messages.....	10
Adjusting the Alarm Parameters.....	11
Calling Up Stored Alarm Events and Reading the Temperature Progression.....	11
Reset HAn.....	11
Resetting the Recorded Temperature Progression $r \bar{t}$	12
Alarm Test	12
Calibrating the Control Sensor	12
Product Sensor.....	12
Calibrating the Product Sensor	13
Switching the Temperature Display Between Control Sensor and Product Sensor	13
Changing the Network Address	13
Resetting the Parameters to Factory Settings.....	13
Setting the Real Time Clock.....	14
Defrosting.....	14
Setting the Display Indication for the Defrost Phase	15
Temperature Display Mode	15
Keypad Lock	15
Interior Light.....	16
Safety Lock	16
Cleaning.....	16
Cleaning the Dust Filter	17
Turning Off the Appliance.....	17
Troubleshooting	18
Customer Service	18
Changing Over Door Hinges Model LRT30W1HC	20

Please Read and Follow these Instructions

These instructions contain Danger, Warning and Caution notes.

This information is important for safe and efficient installation and operation.

Always read and comply with all Danger, Warning and Caution notes!

DANGER!

Danger indicates a hazard which will cause serious injury or death if precautions are not followed.

WARNING!

Warning indicates a potentially hazardous situation which, if not avoided, could result in death or serious injury.

CAUTION!

Caution indicates a potentially hazardous situation which, if not avoided, may result in minor or moderate injury.

IMPORTANT

This indicates information that is especially relevant to a problem-free installation and operation.

California Proposition 65

- This product contains chemicals known to the state of California to cause cancer or reproductive harm.
- This product can expose you to chemicals including Diisononyl Phthalate (DINP) which is known to the State of California to cause cancer. For more information go to www.P65Warnings.ca.gov.
- This product can expose you to chemicals including Di-isodecyl Phthalate (DIDP) which is known to the State of California to cause birth defects or other reproductive harm. For more information go to www.P65Warnings.ca.gov.

IMPORTANT

All types and models are subject to continuous improvement. The manufacturer reserves the right to make modifications to the shape, equipment and technology.

Disposal of Old Appliance

**DANGER!**

Risk of child entrapment.

Child entrapment and suffocation are not problems of the past.

Junked or abandoned refrigerators are still dangerous – even if they will sit for “just a few days.”

If you are getting rid of your old refrigerator, please follow these instructions to help prevent accidents.

Before you discard old appliances:

- Take off the doors.
- Leave the shelves in place so that children may not easily climb inside.
- Cut off the power cable from the discarded appliance. Discard separately from the appliance.
- Be sure to follow your local requirements for disposal of appliances.

Contact the trash collection agency in your area for additional information.

Disposal of this Appliance

This appliance contains flammable gases within the refrigeration circuit and insulation foam.

Contact the municipality or disposal company in your area for information on approved recycling or disposal.

Disposal of Batteries

A rechargeable battery is installed in the appliance.

The battery must be removed when you wish to dispose of the appliance and sent for separate waste treatment for batteries.

Contact a disposal company in your area for information on approved disposal of batteries.

Do not damage or short-circuit the battery.

Disposal of Carton

The packaging is designed to protect the appliance and individual components during transport and is made of recyclable materials.

**WARNING!**

Keep packaging materials away from children. Polythene sheets and bags can cause suffocation!

If possible, please recycle packaging material at a recycling facility.

R290 Refrigerant

**WARNING!**

The refrigerant R290 contained within the appliance is environmentally friendly, but flammable. Leaking refrigerant can ignite.

To prevent possible ignition, follow the warnings below:

- Keep ventilation openings, in the appliance enclosure or in the built-in structure, clear of obstruction.
- To ensure proper ventilation, the clearance between the appliance top and the ceiling must be at least 12 inches.
- Do not use mechanical devices or other means to accelerate the defrosting process, other than those recommended by the manufacturer.
- Do not damage the refrigerant circuit.
- Component parts and power cords shall be replaced with like components performed by factory authorized service personnel only.
- Do not use electrical appliances inside the food storage compartments of the appliance, unless they are of the type recommended by the manufacturer.

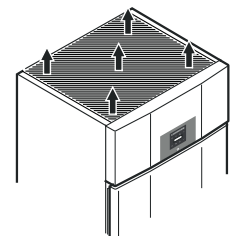

SAFETY

Important Safety Information

- If the appliance is damaged on delivery, contact the supplier immediately before connecting it to the power source.
- To guarantee safe operation, ensure that the appliance is set up and connected as described in this manual.
- Disconnect the appliance from the power source if a fault occurs. Pull out the plug, turn off or disable the power source.
- When disconnecting the appliance, always pull it out by the plug; never pull on the cable.
- Any repairs and work on the appliance should only be performed by the customer service department. Unauthorized work may be dangerous to the user. The power source cable should only be changed or replaced by the customer service department.
- Do not store explosives or sprays using combustible propellants such as butane, propane, pentane, etc. in the appliance. Electrical components might cause leaking gas to ignite. You can identify such sprays by the printed contents or a flame symbol.
- To prevent possible injury due to an electrical shock, be sure to disconnect the power cord or turn off the circuit breaker before cleaning the appliance.
- To avoid injury or damage to the appliance, do not use steam cleaning equipment to clean the appliance.
- Do not operate the appliance in the presence of explosive fumes.
- In the event of a power outage, open the door as infrequently as possible.
- To protect the appliance from possible damage, allow it to stand 1/2 to 1 hour in place before turning on the electricity. This allows the refrigerant and system lubrication to reach equilibrium.

Electrical Safety

Connect this appliance to a 15 amp or 20 amp, 110-120 VAC, circuit which is grounded and protected by a circuit breaker or fuse.

We recommend using a dedicated circuit for this appliance to prevent circuit overload and the chance of interruption to the appliance.

This appliance is equipped with a three-prong (grounding) polarized plug for your protection against possible shock hazards.

Where a two-prong wall receptacle is encountered, contact a qualified electrician and have it replaced with a properly grounded three-prong receptacle in accordance with all local codes and ordinances.



WARNING!

Electrocution hazard.

Electrical grounding required.

- **Do not remove the round grounding prong from the plug.** →
- **Do not use extension cords or ungrounded (two-prong) adapters.**
- **Do not use a power cord that is frayed or damaged.**

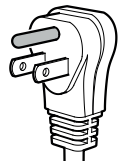

- **Do not use a power strip.** →

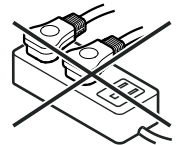

Failure to follow these instructions may result in fire, electrical shock or death.

Blocking for Safety



WARNING!

To avoid a hazard due to instability of the appliance, it must be fixed in accordance with the instructions.

Safety Regulations

The appliance is designed to cool and store laboratory preparations at temperatures of between 28°F and 60°F (-2.2°C and +15.5°C).

The appliance is not suitable for use in explosion-hazard areas.

If valuable or temperature-sensitive substances or products are stored, a separate, continuously monitoring alarm system must be used. This alarm system must be designed so that each alarm status is detected immediately by an authorized person who can then take appropriate action.

IMPORTANT

The appliance is not intended for outdoor use.

The appliance is not intended for storage of blood or blood products.

Climate rating

The climate rating indicates at what room temperature the appliance may be operated to achieve full cooling capacity and what the maximum humidity level in the area around the appliance may be to ensure that no condensation forms on the exterior housing.

Climate Rating	Max. Ambient Temperature	Max. relative humidity
5	104°F (40°C)	40%

The minimum room temperature at the place of installation is 50°F (10°C).

IMPORTANT

Do not operate the appliance outside the specified ambient temperature range.

- The refrigerant circuit has been tested for leaks.
- The appliance complies with current safety regulations C22.2 No. 120-13, UL 471 - 10th Edition

We recommend cleaning the appliance before turning it on for the first time. See **Cleaning**.

WARNING!

Do not allow children to play with the appliance. Children must not climb, sit or stand on the shelves or door.

Failure to follow these instructions may result in death or serious injury.

External Alarm Outputs

The electronic control system is equipped with a floating alarm output and an RS485 interface.

For information about connecting the appliance to an external alarm or temperature monitoring system, please contact your dealer.

Setting Up

CAUTION!

To avoid risk of personal injury or property damage, have two people to move this appliance into place.

Avoid placing the appliance in direct sunlight or near the stove, range top, radiators and similar heat sources.

- Examine the unit and packaging for shipping damage. Contact the carrier immediately if you suspect there is any damage.

Supplied Equipment

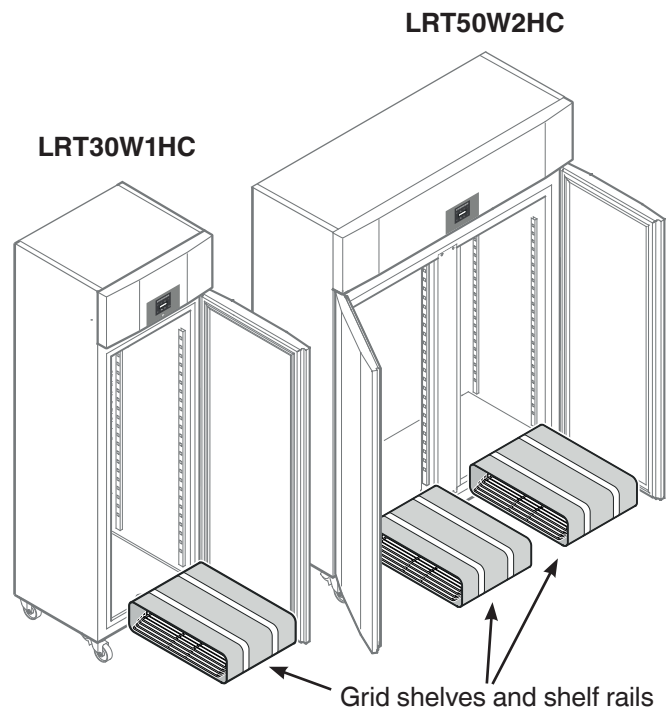

FEATURES

Installing the Equipment

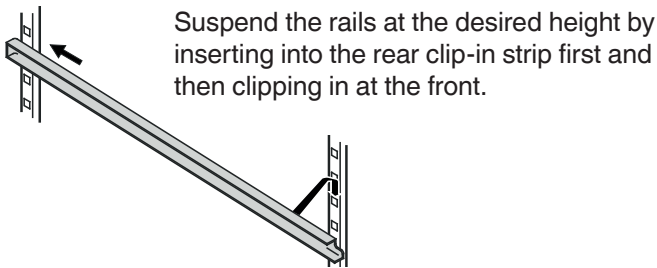
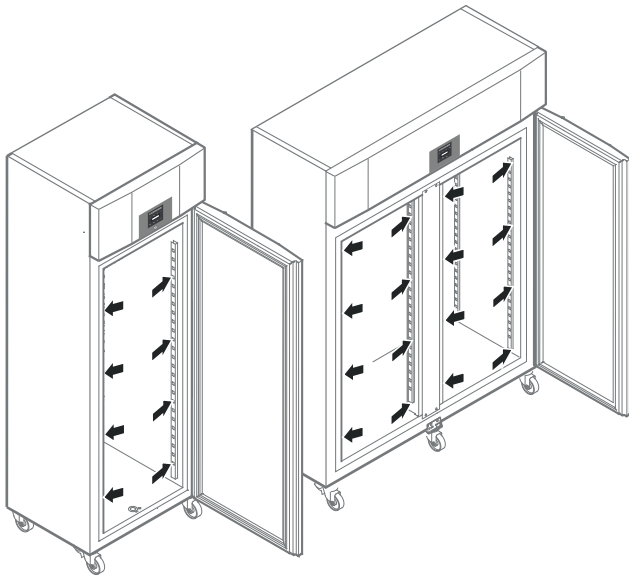

Suspend the rails at the desired height by inserting into the rear clip-in strip first and then clipping in at the front.

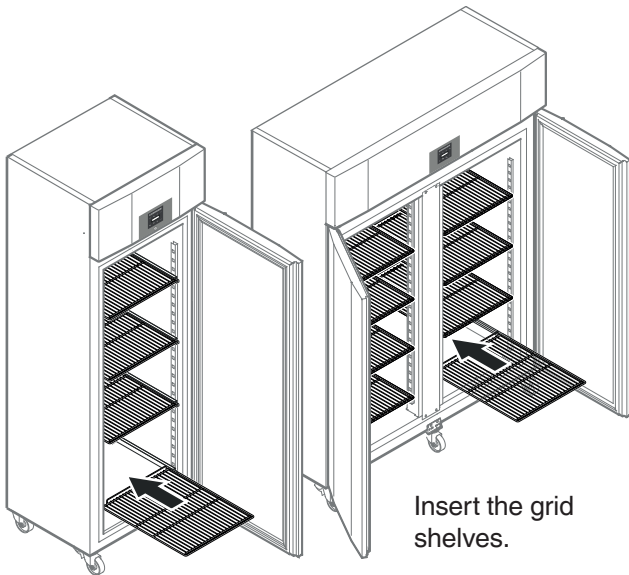

Insert the grid shelves.

Intermediate shelves LRT50W2HC

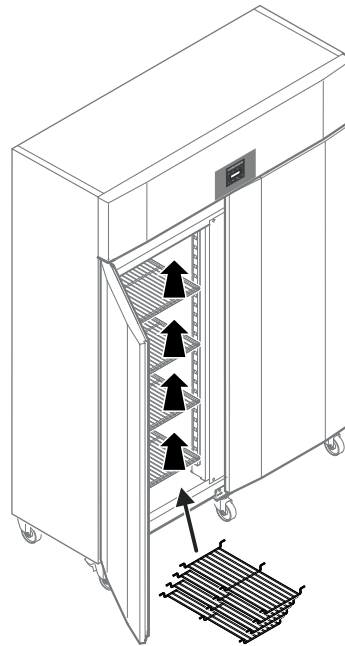

Place the supplied intermediate shelves onto the shelf rails.

IMPORTANT
The maximum load per intermediate shelf is 44 lbs (20 kg).

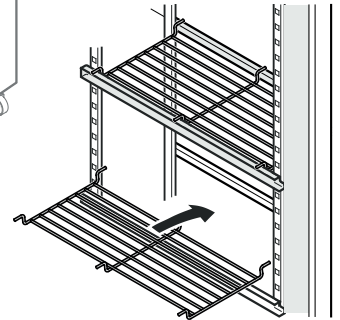

Castors

To easily move the appliance on the floor, it is equipped with castors. The left and right front castors are lockable to keep the appliance in position.

CAUTION!

Risk of injury due to high spring tension.

Do not try to operate the locking lever with your hands.

Always operate with protective footwear.

Locking the castor

Press down the lever at the front with the tip of your shoe until it snaps into place.

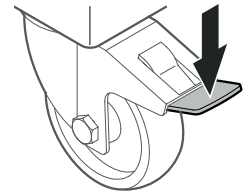

Unlocking the castor

Push back the lever at the top with the tip of your shoe until it snaps back to the initial position.

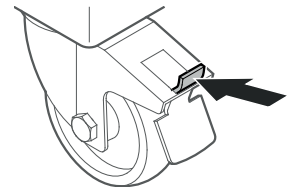

Dimensions

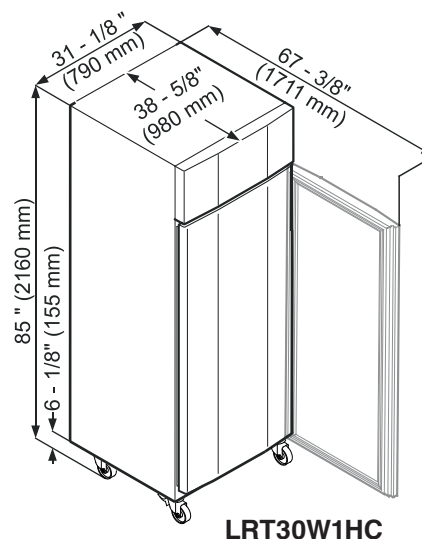
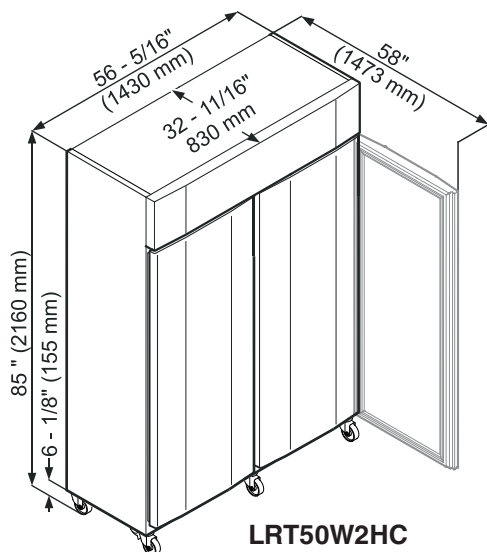

Description of the Appliance

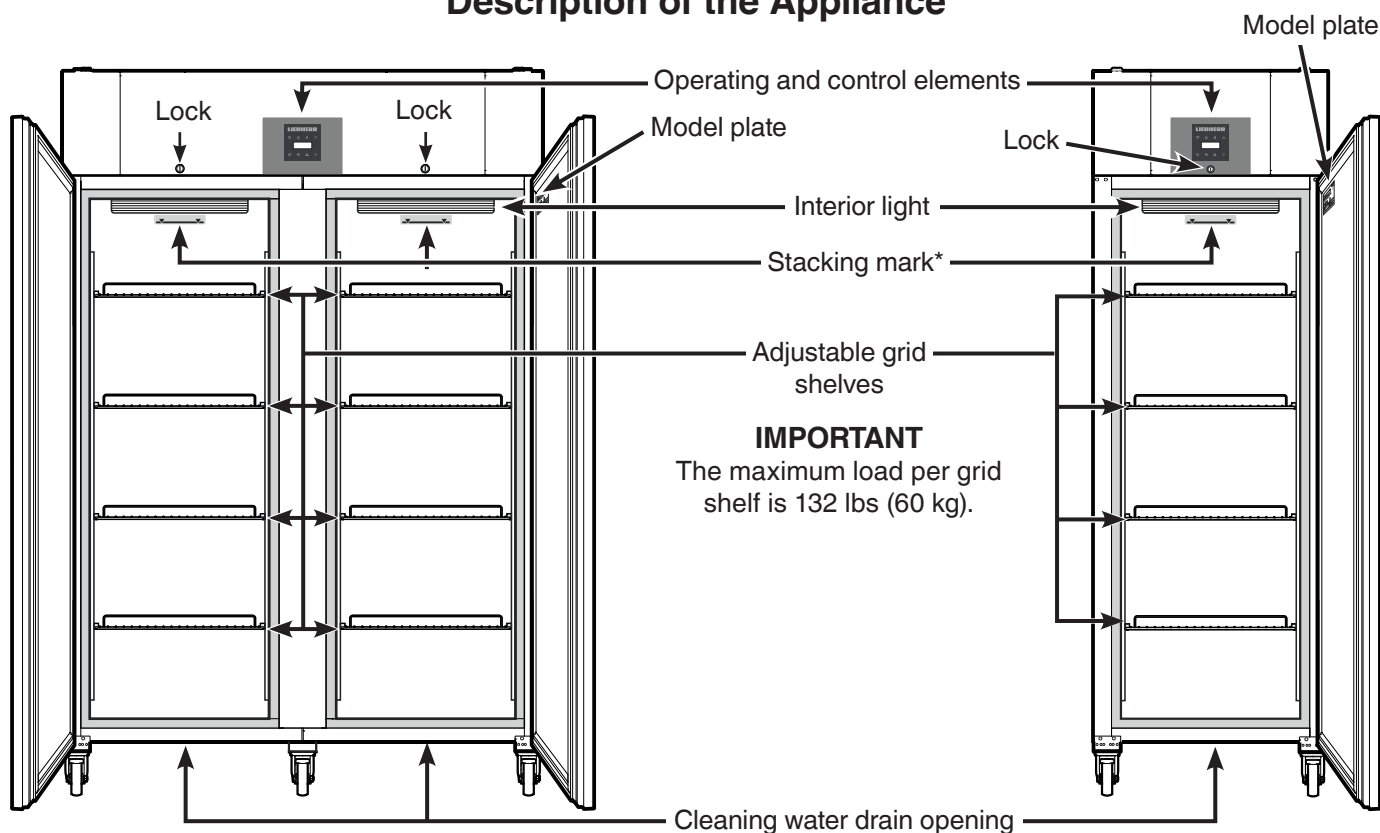

* **Stacking mark** →

Only load the top shelf up to the stacking mark. This is important to ensure that the air can circulate properly and the temperature is even throughout the interior.

A drain hose with an R 3/4 connection can be fitted to the underside of the appliance. The water which collects in the interior during cleaning can be drained off in this way. An angled connector is supplied with the appliance.

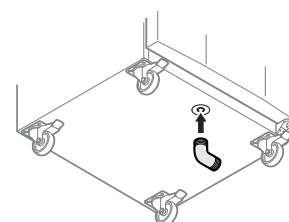

OPERATION

Back-up Battery

Before the appliance is turned on, the battery installed in the compressor compartment must be connected.

This battery ensures that alarms are always reported, even in the event of a power failure.

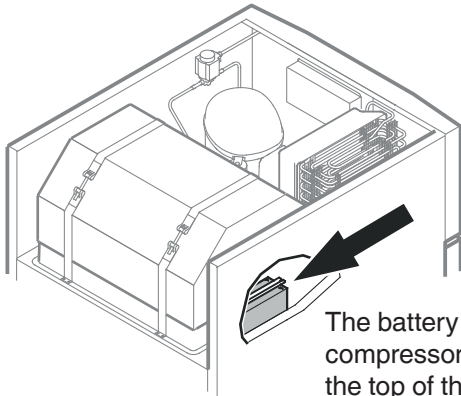

The battery is installed in the compressor compartment at the top of the appliance.

IMPORTANT

The back-up battery should be connected before the appliance is turned on. Otherwise, a fault message will be displayed (LED flashes and **bEtE** appears).

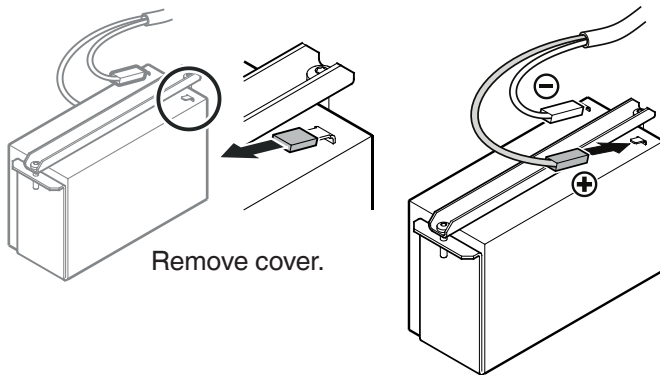

Remove cover.

Attach the connector to the positive pole on the battery.

Operating and Control Elements



- On/Off button (switching the appliance on and off)
- AlarmLog button (for calling up stored alarm events and reading the temperature progression)
- Keypad lock
- Up button (for navigating in the menu and increasing values)
- Down button (for navigating in the menu and decreasing values)
- Audible alarm Off button
- Defrost button (for manually activating the defrost function)
- Enter button

Symbols in the display

- Compressor is running
- LED flashing. The compressor will start after the pressure in the refrigerant circuit has equalized.
- Fan in the interior is running
- Appliance is defrosting
- Product sensor is activated
- LED flashing and **bEtE** appears in the display. The real time clock must be reset.
- Interior light is on
- HACCP function is activated
- LED flashing. A power outage or interior temperatures outside the permitted range have been recorded.
- Alarm function
- A fault has occurred in the appliance. Contact the customer service department.
- Digital display

Switching the Appliance On and Off

Connect the appliance to the electrical outlet - the **OFF** indicator and the temperature display flash alternately.

Switching the appliance on



Keep the  button pressed for approx. 3 seconds until the temperature display lights up.

No alarm sounds or is displayed when the appliance is switched on for the first time.

If the appliance is disconnected from the electrical outlet for a long time after it has been switched on for the first time and if the temperature inside the appliance rises above the upper alarm limit, this will be detected as a fault by the electronic control system ( appears in the display).

When the appliance is switched on again, this display must be reset as shown below.

- Press button .

- Press  +  for 5 seconds. Display = .

The  LED will now be lit permanently.

- Press  for 5 seconds. The electronic control system switches back to normal operation.

Switching the appliance off

Keep the  button pressed for approx. 3 seconds - the **OFF** indicator and the temperature display flash alternately.

Setting the Temperature

- Press  for 1 second. The temperature display flashes.

- To increase the temperature (warmer): press .

Note

Keep the button pressed down to change the temperature setting continuously.

- To reduce the temperature (colder): press .

- Press  again.

The desired temperature setting is saved.

The temperature can be set at between -2.2°C and +15.5°C (28°F and 60°F).

Door Open Alarm

If the door is left open for more than 1 minute, the audible alarm signal will sound and *door* and the temperature indication flash alternately in the display.



If the door must be opened for a lengthy period in order to place items into the appliance, cancel the audible alarm signal by pressing the  button.



The alarm switches back to standby when the door is shut.



Setting the Delay Time for the Door Open Alarm



The delay time until the audible alarm sounds after the door has been opened can be adjusted.

- Press  for 5 seconds. Display = .

- Press  until  appears in the display.

- Press . Display =  (minute).
Setting range = 1 - 5 minutes.

- Use buttons  and  to select the desired setting.

- Press . Display = .









- Press  for 5 seconds. The electronic control system switches back to normal operation.

Power failure alarm

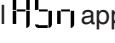
In the case of a power failure, the audible warning signal will sound and *b t P* will be shown in the display.





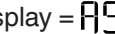

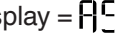

Audible Alarm Settings

The audible alarm will be muted for the current alarm after the  button has been pressed. Complete the following steps if you want the audible alarm function to reactivate automatically.

- Press  for 5 seconds. Display = .
- Press  until  appears in the display.
- Press . Display = .
- Press . Display = .
- Press . Display = .

Automatic reactivation of the audible alarm is now active.

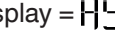
The delay time until the audible alarm sounds again must be set.









- Press . Display = d.
- Press . Display = .
- Time in minutes after which the audible alarm will sound again after the  button has been pressed. Setting range = 1 - 120 minutes.
- Use buttons  and  to select the desired setting.
- Press . Display = d.
- Press  for 5 seconds. The electronic control system switches back to normal operation.

Deactivating the Audible Alarm Function

The audible alarm function can be completely deactivated if necessary.



Note

In this case, the sentence “**The audible alarm signal will sound**” in these operating instructions must be skipped when reading the section in question.

- Press  for 5 seconds. Display = .
- Press  until  appears in the display.
- Press . Display = .
- Use buttons  and  to select the desired setting.

 = audible alarm function activated

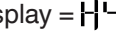
 = audible alarm function deactivated.

- Press . Display = .
- Press  for 5 seconds. The electronic control system switches back to normal operation.

Alarm Messages

1. LED flashes

If  appears in the display, the appliance has a fault. Consult your nearest customer service point.

2. The temperature display flashes alternately with H | or L |

The interior is too warm (HI) or too cold (LO). The audible alarm sounds (unless the audible alarm function has been deactivated).

3. HA / HF / LED flashes

There has been a power outage (HF) of some length or the interior was too warm or too cold (HA) during a certain period of time.

Up to three alarm events can be stored and called up.



Adjusting the Alarm Parameters

The alarm limits (difference to the set temperature) and the alarm delay (delay until alarm sounds) can be adjusted.

Note



After a door has been opened or a defrosting process, the alarm delay Ad will be extended by an additional delay time (60 minutes). This additional delay time must not be changed.

This means that a temperature alarm will appear later after a door has been opened or a defrosting process than is actually set using parameter Ad.

- Press  for 5 seconds. Display = r15.
- Press \wedge until AL appears in the display. (AL = lower alarm limit)
- Press . Display = temperature difference in °F.
- Use buttons \vee and \wedge to select the desired setting.





IMPORTANT

Set positive values only.

- Press . Display = AL.
- Press \wedge . Display = AH (upper alarm limit).
- Press . Display = temperature difference in °F.
- Use buttons \vee and \wedge to select the desired setting.

IMPORTANT

Set positive values only.

- Press . Display = AH.
- Press \wedge . Display = Ad.
- Press . Display = alarm delay in minutes.
- Use buttons \vee and \wedge to select the desired setting.
- Press . Display = Ad.
- Press  for 5 seconds. The electronic control system switches back to normal operation.

Calling Up Stored Alarm Events and Reading the Temperature Progression

- Press . Display = HAr1.
- Scroll through the list using \vee or \wedge .

HAr1 Number of temperature alarms

HA Last temperature alarm

HA | Last temperature alarm but one

HAr2 Temperature alarm before HA |

HF r1 Number of power outages

HF Last power outage

HF | Last power outage but one

HF r2 Power outage before HF |

r t Period in hours in which the maximum and minimum interior temperatures were measured

r H Maximum (highest) measured temperature

r L Lowest measured temperature



- Select the required item using the  button. Press this button again to return to the list.

Note

You can exit the menu at any time by pressing  for 5 seconds.



If no button is pressed within 60 seconds, the electronic control system switches back automatically.

Reset HAn

- Press . Display = HAr1.
- Press  for 5 seconds. Display = r t 5.
- Press  for 5 seconds. The electronic control system switches back to normal operation.

Resetting the Recorded Temperature Progression $r\bar{t}$

Complete the following steps if you want to reset the value saved for $r\bar{t}$ in the previous section to 0.

- Press . Display = $H\bar{A}r$.
- Press ∇ until $r\bar{t}$ appears in the display.
- Press . Display = $0-999$.
- Press ∇ for 5 seconds. Display = $r\bar{t}E5$.

The values for $r\bar{H}$ and $r\bar{L}$ (highest and lowest measured interior temperature) are then reset to the current interior temperature.

- Press  for 5 seconds. The electronic control system switches back to normal operation.

Alarm Test

This test checks the function of the internal and any external connected alarm devices. The appliance's refrigerating function remains switched on during this test.

- Press  + ∇ for 5 seconds.
- The display changes to a temperature value of 0.2°F below the set upper alarm limit.
- The temperature value L now rises by 0.1°F every 2 seconds.
- When the upper alarm limit is reached, $H\bar{I}0$ appears in the display. An external alarm device connected to the floating alarm output is now activated.
- The temperature value continues to rise up to 0.2°F above the upper alarm limit.
- The same process then takes place automatically for the lower alarm limit. $L\bar{I}0$ appears in the display.

The electronic control system automatically switches back to normal operation.

Cancelling the test prematurely

- Press  for 5 seconds.

Note

If the values of the upper and lower alarm limit (**AL** and **AH** in **Adjusting the Alarm Parameters**) are set to 0, $H\bar{-}$ and $L\bar{-}$ will appear in the display during this test.

Note





For a realistic temperature alarm test, an additional delay time (60 minutes) applies as well as the adjustable alarm parameters AL, AH and Ad.

After a door has been opened or a defrosting process, the alarm delay Ad will be extended by an additional delay time (60 minutes). This additional delay time must not be changed.

This means that a temperature alarm will appear later after a door has been opened or a defrosting process than is actually set using parameter Ad.

Calibrating the Control Sensor (standard sensor for temperature control)

Possible tolerances of the control sensor (the displayed temperature compared to the actual interior temperature) can be offset with this function.





- Press  for 5 seconds. Display = $r\bar{t}5$.
- Press \wedge until $r\bar{t}C\bar{I}$ appears in the display.
- Press . Display = correction value set at the factory.
- Use buttons ∇ and \wedge to increase or decrease the correction value in 0.1°F increments.
- Press . Display = actual (corrected) interior temperature.
- Press . Display = $r\bar{t}C\bar{I}$.
- Press  for 5 seconds. The electronic control system switches back to normal operation.

Product Sensor (optional accessory)

The temperature may be measured or recorded at any point in the interior using the product sensor.

For information about ordering and connecting the product sensor, contact your dealer.

Activating the sensor





- Press  for 5 seconds. Display = $r\bar{t}5$.
- Press ∇ until $r\bar{A}3$ appears in the display.
- Press . Display = 0 .
- Press \wedge . Display = 1 .
- Press . Display = $r\bar{A}3$.
- Press  for 5 seconds. The electronic control system switches back to normal operation.

If $- - -$ appears in the display, the product sensor has not been activated.





If $E\bar{C}$ appears in the display, the product sensor has not been connected, or is faulty.

Calibrating the Product Sensor

Possible tolerances of the product sensor (the set temperature compared to the actual interior temperature) can be offset with this function.

- Press  for 5 seconds. Display = $r^1 5$.
- Press \wedge until $r^1 \square$ appears in the display.
- Press . Display = $\square \square$.
- Use buttons \vee and \wedge to increase or decrease the correction value in 0.1°F increments.
- Press . Display = actual (corrected) product sensor temperature.
- Press  for 5 seconds. The electronic control system switches back to normal operation.





Switching the Temperature Display Between Control Sensor and Product Sensor

- Press  for 5 seconds. Display = $r^1 5$.
- Press \wedge . Display = $r^1 \square$.
- Press . Display = \square (control sensor).
- Press \wedge . Display = \square (product sensor).
- Press . Display = $r^1 \square$.
- Press  for 5 seconds. The electronic control system switches back to normal operation.

If the product sensor is activated,  appears in the display.



Changing the Network Address

When connecting several appliances via the RS485 interface, each appliance must have its own network address.

- Press  for 5 seconds. Display = $r^1 5$.
- Press \vee until $H \square$ appears in the display.
- Press . Display = \square .
- Use button \vee or \wedge to change the network address (1 - 207).
- Press . Display = $H \square$.
- Press  for 5 seconds. The electronic control system switches back to normal operation.

Resetting the Parameters to Factory Settings

The alarm limits and sensor calibration values can be reset to the factory settings using this function.

- Disconnect the power cord.
- Keep  pressed down and connect the power cord.
Display = $\square r \square$.
- Press . Display = $\square \square \square$.

The electronic control system automatically switches back to normal operation.





Setting the Real Time Clock

The real time clock is preset (CET). Other time zones or summer/winter time must be adjusted manually.







Note

The time and date values in this section are depicted with 0. The actual numbers displayed when setting the real time clock may vary.

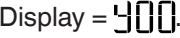





Activating the clock setting

- Press  for 5 seconds. Display = .
- Press . Display = .

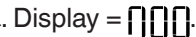

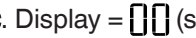



Setting the year

- Press . Display = . Year 0 - 99
- Press . Display =  (single or double digit).
- Set the year by pressing the   buttons.
- Press  = save new setting.

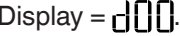





Setting the month

- Press . Display = . Month 1 - 12
- Press . Display =  (single or double digit).
- Set the month by pressing the   buttons.
- Press  = save new setting.

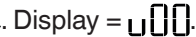

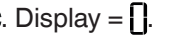



Setting the day

- Press . Display = . Day 1 - 31
- Press . Display =  (single or double digit).
- Set the day by pressing the   buttons.
- Press  = save new setting.







Setting the day of the week

- Press . Display = .
Day of the week: 1 = Monday, 7 = Sunday.
- Press . Display = .
- Set the day of the week by pressing the   buttons.
- Press  = save new setting.

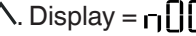
Setting the hour

- Press . Display = . Hour 0 - 23
- Press . Display =  (single or double digit).
- Set the hour by pressing the   buttons.
- Press  = save new setting.

Setting the minute

- Press . Display = . Minute 0 - 59
- Press . Display =  (single or double digit).
- Set the minute by pressing the   buttons.
- Press  = save new setting.

Exiting the clock setting

- Press  for 5 seconds. The electronic control system switches back to normal operation.

Note



When  appears in the display, the real time clock must be reset.

Defrosting

The appliance defrosts automatically. The defrost water drains into a tray near the refrigeration unit and evaporates automatically through the compressor heat.

Activating the Defrost Function manually

When the appliance door has been left open for a long time, the evaporator may become frosted. The defrost function can then be activated manually.









- Press  for 3 seconds. Display =  + .



The electronic control system switches back to normal operation after the evaporator is defrosted.



The defrost function can be stopped earlier by pressing the  button again.

Display = .



Setting the Display Indication for the Defrost Phase

- Press  for 5 seconds. Display = .
- Press  until  appears in the display.
- Press . Display = .
- Use buttons  and  to select the desired setting.

 =  + alternating display of  and the current temperature in the interior of the appliance.

 =  + temperature before the start of the defrost phase (factory setting).







 = Symbol  + .

- Press . Display = .
- Press  for 5 seconds. The electronic control system switches back to normal operation.

Temperature Display Mode



You can choose the **unit of temperature** for the display in degrees Fahrenheit or degrees Celsius.

The factory setting is degrees Celsius.

- Press  for 5 seconds. Display = .
- Press . Display = .
- Use buttons  and  to select the desired setting.

 = °C











 = °F

- Press . Display = .
- Press  for 5 seconds. The electronic control system switches back to normal operation.







Keypad Lock

The keypad lock ensures that no unintentional changes are made to the electronic control system.

Setting a PIN code for the keypad lock function

- Press  for 5 seconds. Display = .
- Press  until  appears in the display.
- Press . Display = .
- Use button  or  to choose a PIN code between 1 and 999.
- Press  at the desired code number.
- Press  for 5 seconds. The electronic control system switches back to normal operation.

Activating the keypad lock







- Press . Display = .
- Enter the PIN code using button  or .
- Press . Display = .

All functions except  and  are locked.

Note

If an incorrect PIN code is entered, the electronic control system switches back to normal operation without activating the keypad lock.

Deactivating the keypad lock

- Press . Display = .
- Enter the PIN code using button  or .
- Press . Display = .

All functions are enabled.

Note

If an incorrect PIN code is entered, the keypad lock remains active.

OPERATION

Interior Light

The interior light will always switch on when the appliance door is opened.

The  symbol appears in the display.

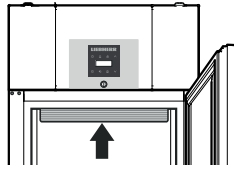

The interior light will go out after the door is closed.

The light intensity of the LED light corresponds to laser class 1/1M.

IMPORTANT

The light cover may only be removed by customer service staff.

CAUTION!

Risk of eye damage.

If the cover is removed, do not look directly at the light through optical lenses from a close distance.

Safety Lock

The lock is equipped with a safety mechanism.

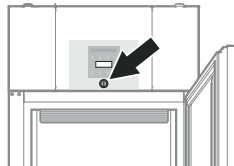

Locking the appliance

- Insert the key and push as shown by arrow 1.
- Turn the key 180° counterclockwise 2.



Unlocking the appliance

- Insert the key and push as shown by arrow 1.
- Turn the key 180° clockwise 2.



WARNING!

Risk of child entrapment and suffocation due to a locked appliance door.

Keep the key in a safe place out of reach of children and not in the vicinity of the appliance.

Cleaning

WARNING!

- To prevent possible injury due to an electrical shock, be sure to disconnect the power cord or turn off the circuit breaker before cleaning the appliance.
- To avoid injury or damage, do not use steam cleaning equipment to clean the appliance.

Cleaning the appliance interior

- Remove the grid shelves.

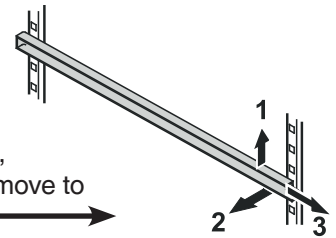

- Remove the shelf rails. Lift the rail at the front (1), move inwards (2) and remove to the front (3).

- Remove the plug from the drain opening.

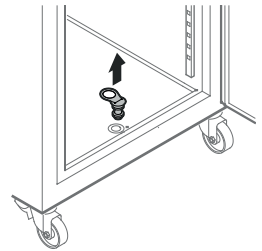

- Clean the inside of the appliance and equipment parts with lukewarm water and a little detergent.
- Thoroughly dry all parts with a cloth.
- Do not damage or remove the model plate on the inside of the appliance. It is very important for servicing your appliance.
- Insert the shelf rails as shown in **Installing the Equipment**.
- Insert the grid shelves.
- Insert the plug into the drain opening.

IMPORTANT

To avoid malfunctions due to heavy frost on the evaporator, the plug must be inserted.

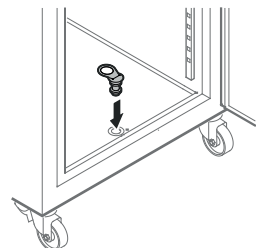

Cleaning the appliance outside

- Clean the door surface and outer walls with lukewarm water and a little detergent or a good-quality stainless steel cleaner.

IMPORTANT

Do not use abrasive or scouring pads or sponges. Do not use concentrated cleaning agents. Never use abrasive or acid-based cleaners or chemical solvents. Otherwise, the stainless steel surface will be permanently damaged.

- Ensure no cleaning water penetrates into the electrical components. →

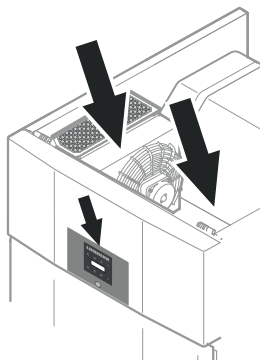

Turning Off the Appliance

If the appliance is to be left switched off for any length of time, complete the following steps to disconnect the power failure alarm battery from the electronic control system.

- Keep the  button pressed for approx. 3 seconds.
- > The **OFF** indicator and the temperature display flash alternately.
- Remove the connector of the battery. →

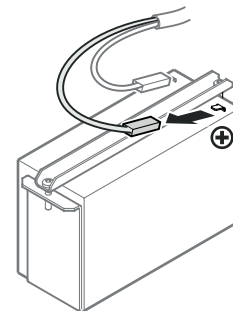

Cleaning the Dust Filter



WARNING!

Electrocution hazard.

Do not clean the dust filter when the appliance is connected to the electrical outlet.

Disconnect the power cord or turn off the circuit breaker before cleaning the dust filter.

IMPORTANT

Clean the dust filter at least twice per year.

- Remove the dust filter by moving it upwards.
- Clean the filter with water and detergent.
- Dry the dust filter and reinstall it.

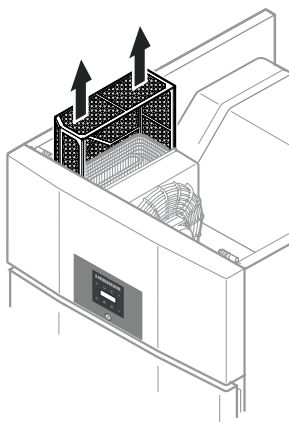

TROUBLESHOOTING

Troubleshooting

Your appliance is designed and manufactured for a long life and reliable operation.

If a problem occurs during operation, check whether it is due to an operating error.

Please note that even during the warranty period, you may be responsible for certain repair costs.

Problem	Possible cause and remedy
Appliance does not work, display is off.	<ul style="list-style-type: none"> - Is the appliance turned on? - Is the power cord properly inserted in the outlet? - Is the circuit breaker or fuse in working order?
Motor seems to run too long.	<ul style="list-style-type: none"> - Is the ambient temperature too hot? See Safety Regulations. - Has the appliance been opened too often or left open too long?
The temperature is not cold enough.	<ul style="list-style-type: none"> - Is the temperature setting correct? See Setting the Temperature. - Does a separately installed thermometer show the correct reading? - Is the ventilation system working properly? - Is the appliance set up too close to a heat source?
Temperature alarm test does not work as required.	- See „Adjusting the alarm parameters“ and „Alarm test“
Error codes displayed	Cause and further action
E0 or E1 or E2 or rE	Sensor error. > Contact the customer service department.
EE or EF	Error in the electronic control system. > Contact the customer service department.
LO	Temperature in the interior is too low. > Contact the customer service department.
HI	Temperature in the interior is too high (warm). > First make sure that the door is closed properly. If the HI display does not disappear after approx half an hour, contact the customer service department.
dor	The appliance door has been left open for more than 1 minute. > Close the door.
Etc	Real time clock error. > Reset the real time clock.
btE	Back-up battery error. > Check if the battery is connected properly. See Back-up Battery . If the connection is correct and the error code is still displayed, contact the customer service department.
HF or HA	There has been a power outage (HF) of some length or the interior was too warm or too cold (HA). > See Calling Up Stored Alarm Events and Reading the Temperature Progression .

Customer Service

If none of the above possible causes apply, and you can not rectify the fault yourself, contact the customer service department. Indicate the type (1) of appliance, service number (2) and the appliance / serial number (3) as shown on the model plate.

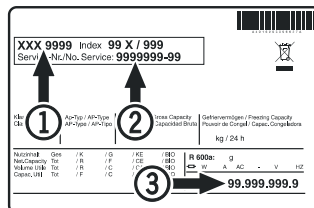

The position of the model plate is shown in the section entitled **Description of the Appliance**.

COMMERCIAL LABORATORY AND MEDICAL PRODUCTS

FULL THREE YEAR WARRANTY

For three years from the date of original purchase, your Liebherr warranty covers all parts and labor to repair or replace any part of the product which proves to be defective in materials or workmanship under normal and proper use and maintenance as specified by Liebherr and upon proper installation and start-up in accordance with the Owner's Use and Care Guide supplied with each Liebherr unit.

TERMS APPLICABLE TO EACH WARRANTY

This warranty will apply to products purchased and located in the United States and Canada. Products must be purchased in the country where service is requested. Any part covered under the above warranties that is determined by Liebherr to have been defective within the time frame is limited to the repair or replacement, including labor charges, of defective parts or assemblies. The labor warranty will include standard straight time labor charges only and reasonable travel time, as determined by Liebherr. This warranty is void for any misuse of the intended application of these products.

All service provided by Liebherr under the warranty must be performed by authorized Liebherr service representatives, unless otherwise specified by Liebherr. The warranty does not cover any parts or labor to correct any defect or damage caused by negligence, accident, fire, flood, acts of God, improper use, improper maintenance, improper delivery, improper installation, power interruptions, power surges, incorrect electric current, voltage or supply, use of extension cords, improper grounding, removal and reinstallation of the product if it is not installed in accordance with published installation instructions or in an inaccessible location, service cost or service call to instruct the user on the proper use of the product or repairs to parts or systems resulting from unauthorized modifications made to the product repairs when the product is used in a manner that is contrary to published user or operator instructions and/or installation instructions.

Liebherr is not responsible for economic loss, profit loss or direct, indirect or consequential damages, losses or other costs and expenses resulting from any spoilage of any items stored in a Liebherr refrigeration system including refrigerators, freezers, and wine coolers whether they be food, medicine, wine or otherwise. In no event will Liebherr have any liability or responsibility whatsoever for damage to surrounding property, including but not limited to cabinetry, floors, ceilings and other structures or objects around the product. You are solely responsible for any structure and setting for the product including but not limited to all electrical, plumbing or other connecting facilities, for proper foundation/flooring and for any alterations including without limitation cabinetry, walls, flooring and shelving. Warranties are void if the original serial numbers have been removed, altered or cannot be readily determined. Liebherr reserves the right to amend or alter this warranty and/or any warranty terms at Liebherr's discretion.

THE REMEDIES DESCRIBED ABOVE FOR EACH WARRANTY ARE THE ONLY ONES WHICH LIEBHERR WILL PROVIDE, EITHER UNDER THESE WARRANTIES OR UNDER ANY WARRANTY ARISING BY OPERATION OF LAW. LIEBHERR WILL NOT BE RESPONSIBLE FOR ANY CONSEQUENTIAL OR INCIDENTAL DAMAGES ARISING FROM THE BREACH OF THESE WARRANTIES OR ANY OTHER WARRANTIES, WHETHER EXPRESS, IMPLIED OR STATUTORY.

Some states/provinces do not allow the exclusion or limitation of incidental or consequential damages so the above limitation or exclusion may not apply to you. This warranty gives you specific legal rights and you may also have other legal rights which vary from state to state, or province to province.

For all other warranty inquiries or to receive parts and/or service and the name of the Liebherr authorized service representative nearest you, for the USA and Canada, contact the Liebherr designated national service provider at **service-commercial.us@ liebherr.com** or call **1-844-LICOSVC (1-844-542-6782)** or contact your authorized Liebherr dealer or distributor.

CHANGING OVER DOOR HINGES

Changing Over Door Hinges Model LRT30W1HC

Door hinges should only be changed by a trained expert.

Changing over the door hinges requires two people.

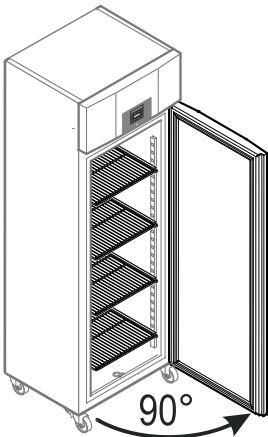

1. Open the door approx. 90°.

IMPORTANT

The door must be opened 90° before the lower hinge bracket is removed.

This will hold the self-closing mechanism that is integrated into the door in the required position for installation.

IMPORTANT

If the door is removed and reinstalled in the closed position, this will lead to destruction of the self-closing mechanism on the first opening of the door.

CAUTION!

Risk of injury and damage due to a falling appliance door.

The door must be held secure by one person to ensure that a second person can remove or install the hinge components.

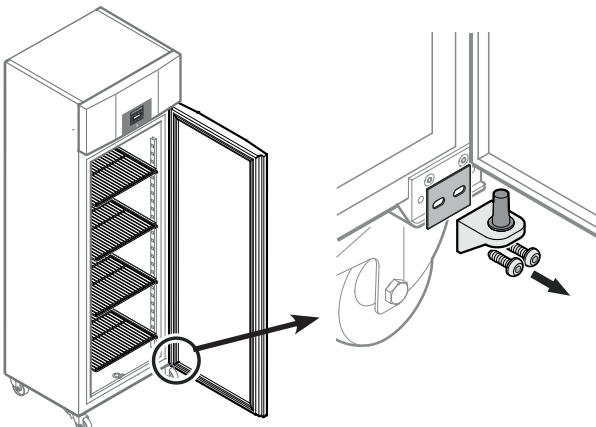

2. Remove the hinge bracket and spacer plate.
Remove the door downwards.

3. Remove the hinge components from the hinge bracket.

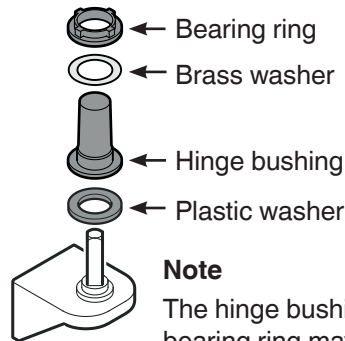

Note

The hinge bushing with brass washer and bearing ring may stick in the door mounting when you pull out the hinge bracket and, in this case, must be removed from it.

4. Remove bearing ring from upper door mounting.

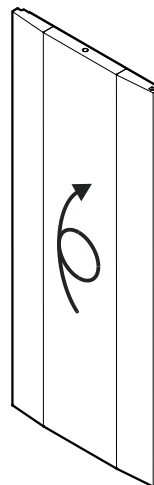
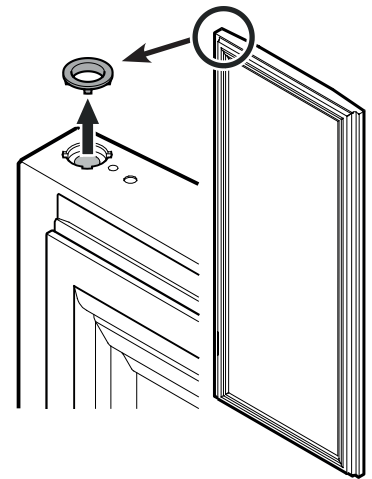

5. Turn the door by 180°.

6. Insert the bearing ring and hinge bushing into the upper door mounting.

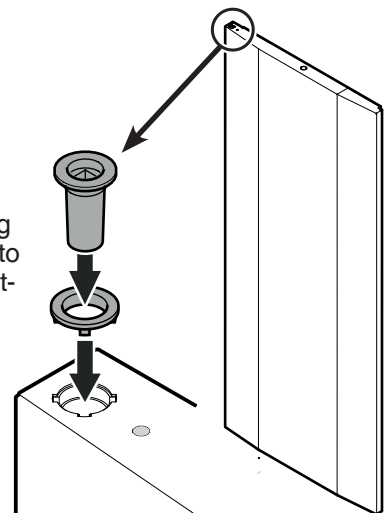

CHANGING OVER DOOR HINGES

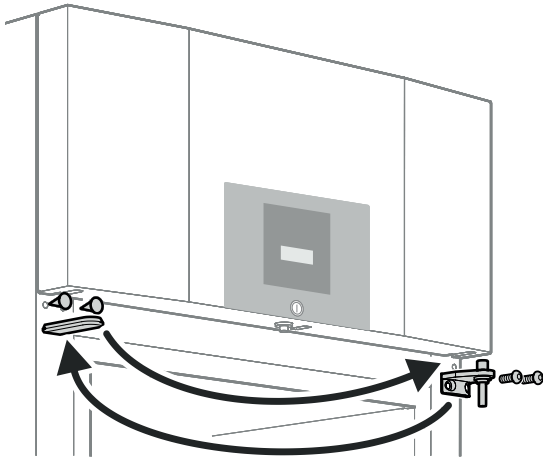

7. Transfer upper hinge bracket and covers to the opposite side.

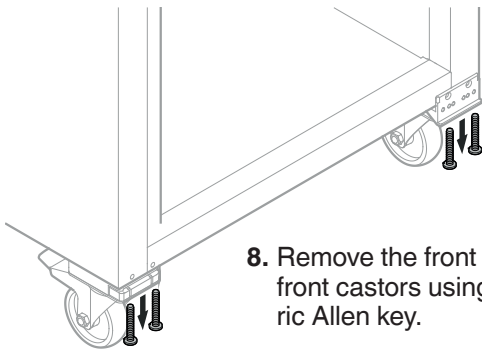

8. Remove the front screws of the front castors using a 4 mm metric Allen key.

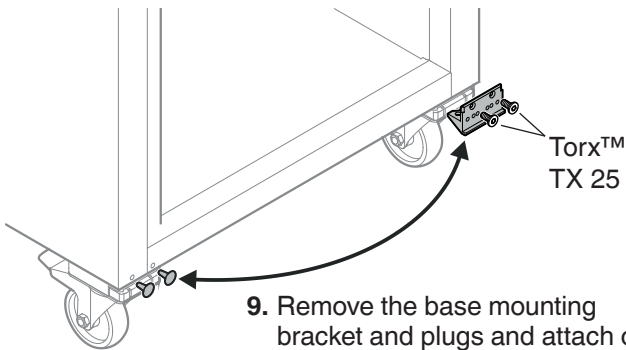

9. Remove the base mounting bracket and plugs and attach on the other side.

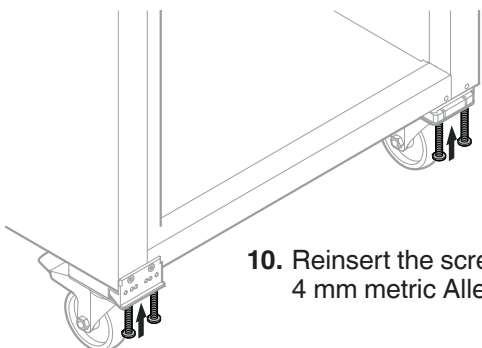

10. Reinsert the screws, using a 4 mm metric Allen key.

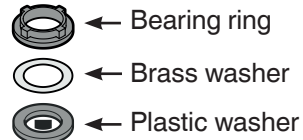

11. Fit the hinge components on the hinge bracket.

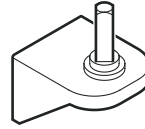

12. Keeping the door open at 90°, suspend in top square pin.

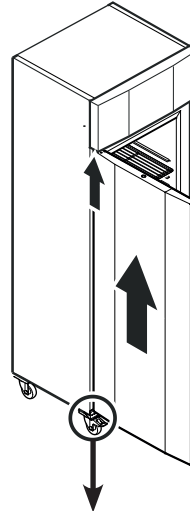

IMPORTANT

It is essential that the door is open at an angle of 90° during installation.

If the door is installed in the closed position, this will lead to destruction of the self-closing mechanism on the first opening and closing of the door.

13. Install the hinge bracket with the fitted hinge components in the lower door mounting.

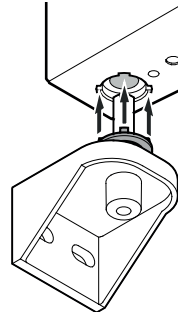

Note

The tabs on the bearing ring must fit into the recesses of the door mounting during installation. If necessary, rotate the upper ring.

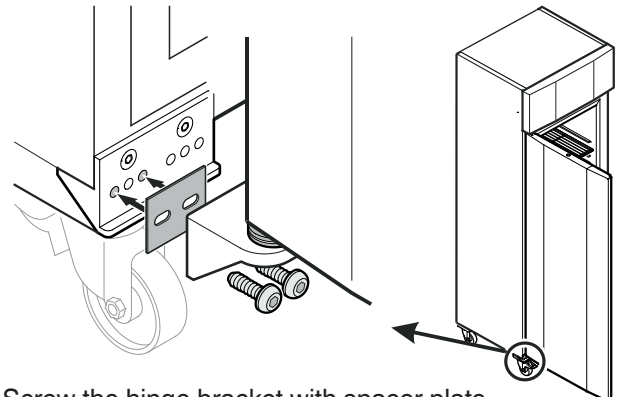

14. Screw the hinge bracket with spacer plate into place using a 4 mm metric Allen key.

IMPORTANT

Tighten the screws firmly.

For Service in the U.S. and Canada

Toll Free: **1-844-LICOSVC or 1-844-542-6782**

Email: **service-commercial.us@liebherr.com**



www.liebherr-appliances.com