

Operating instructions

Combined refrigerator-freezer

Read the operating instructions before switching on for the first time

Page 36

EN

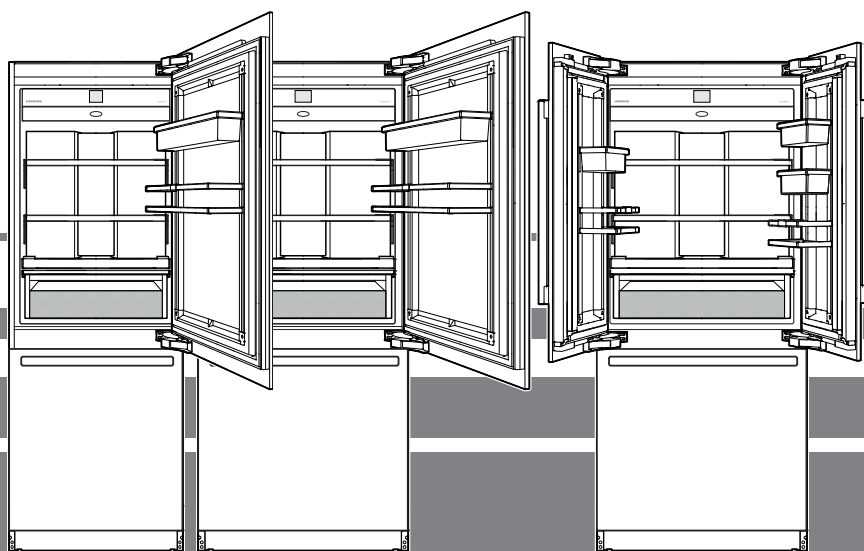

7080 406-01



ECBN 94 / ECBN 96 / ECBN.. 97.. / ECBN.. 99..

LIEBHERR



Content

Priority of warnings.....	36
Symbols on the appliance:	36
Safety instructions and warnings	37
Disposal notes.....	38
EPREL database:	38
Range of appliance use.....	38
Climate rating	38
Description of the appliance.....	39
Control panel	40
Fast access to information	40
Switching the appliance on	40
Main menu.....	41
Setting the temperature.....	42
Setting the temperature (refrigerator compartment)	42
Setting the temperature (freezer compartment).....	43
Setting the temperature (BioFresh-Plus compartment)	43
SuperCool	44
SuperFrost.....	45
Notes on freezing	45
Safety instructions and warnings for the IceMaker	46
IceMaker description.....	46
Switching the IceMaker on	46
Switching the IceMaker off	47
Switching the IceMaker to maximum ice production.....	47
PartyMode.....	48
HolidayMode	48
SabbathMode.....	49
Switching the appliance off	49
Maintenance message	50
Maintenance confirmation.....	50
Setup menu	51
SmartDeviceBox (not supplied in all countries).....	53
Description of the SmartDevice display	53
Alarm messages	54
Equipment	57
Water dispenser	57
BioFresh-Plus compartment	58
Cleaning	58
Maintenance menu.....	60
Maintenance.....	61
Additional functions.....	64
Saving energy	69
Malfunctions.....	69
Shutting your appliance down	69

Priority of warnings

 DANGER!	identifies a situation involving direct danger which, if not obviated, may result in death or severe bodily injury.
 WARNING!	identifies a dangerous situation which, if not obviated, may result in death or severe bodily injury.
 CAUTION!	identifies a dangerous situation which, if not obviated, may result in minor or medium bodily injury.
NOTICE	identifies a dangerous situation which, if not obviated, may result in damage to property.
Note	identifies useful information and tips.

Symbols on the appliance:

	This symbol may be located on the compressor. It relates to the oil in the compressor and makes reference to the risk that: Swallowing or inhaling can be fatal. This advice is only relevant to recycling. There is no danger in normal operation.
	This symbol is located on the compressor and indicates the danger of flammable materials. Do not remove the sticker.
	This or a similar sticker may be located on the rear of the appliance. This sticker indicates that there are vacuum insulation panels (VIP) or perlite panels in the door and/or housing. This advice is only relevant to recycling. Do not remove the sticker.

Note

All types and models are subject to continuous improvement. The manufacturer reserves the right to make modifications to the shape, equipment and technology.

Safety instructions and warnings

- **WARNING:** do not seal ventilation openings on the appliance housing or enclosure.
- **WARNING:** only use the mechanical devices or other aids recommended by the manufacturer to help speed up the defrosting process.
- **WARNING:** do not damage the refrigerant circuit.
- **WARNING:** do not use any electrical devices in the refrigerator compartment which do not comply with the design recommended by the manufacturer.
- **WARNING:** the mains cable must not be damaged while installing the appliance.
- **WARNING:** multi-sockets or distributor strips and other electronic devices (such as halogen transformers) must not be positioned and operated at the rear of appliances.
- **WARNING:** danger of injury through electric shock. There are live parts under the cover. Only have the interior LED light replaced or repaired by customer service staff or trained personnel.
- **WARNING:** risk of injury from the LED lamp. The light intensity of the LED light complies with risk group RG 2. If the cover is defective, do not look directly at the light through optical lenses from close distance. This may damage your eyes.
- **WARNING:** this appliance must be secured as described in the operating instructions (installation instructions) to rule out any potential risks due to its instability.
- Do not stand on the plinth, drawers or doors or use them to support anything else.
- This appliance may be used by children aged 8 and over and by people with reduced physical, sensory or mental abilities or a lack of experience and expertise if they are supervised or have been instructed on the safe use of the appliance and have understood the risks associated with it. Children must not be allowed to play with the appliance. Cleaning and user maintenance must not be carried out by children without supervision. Children aged between 3 and 8 are allowed to load and unload the appliance.
- Do not store any explosive substances, such as aerosol containers with flammable propellant gas, inside the appliance.
- To prevent injury or damage to the unit, the appliance should be unpacked and set up by four people.
- After unpacking it, check the appliance for signs of damage. Contact the supplier if it is damaged. Do not connect the appliance to the mains power supply.
- Avoid prolonged skin contact with cold surfaces (e.g. chilled/frozen products). If necessary, take safety action (e.g. gloves).
- Do not consume food which has been stored for too long, as it could cause food poisoning.
- All repairs and work on the appliance may only be carried out by customer service personnel or other trained personnel. The same applies to changing the mains power cable.
- Only carry out repair and other work on the appliance when the mains plug has visibly been disconnected.
- Only install, connect and dispose of the appliance as described in these operating instructions.
- In the event of a fault, pull out the plug or switch off the fuse.
- When disconnecting the appliance from the mains, pull on the plug. Do not pull on the cable.
- If you have a lockable appliance, do not keep the key near the appliance or within reach of children.

Description of the appliance

ECBN9471/ECBN..97..

ECBN 9671 /ECBN.. 99.1

ECBN 9673 /ECBN.. 99.3

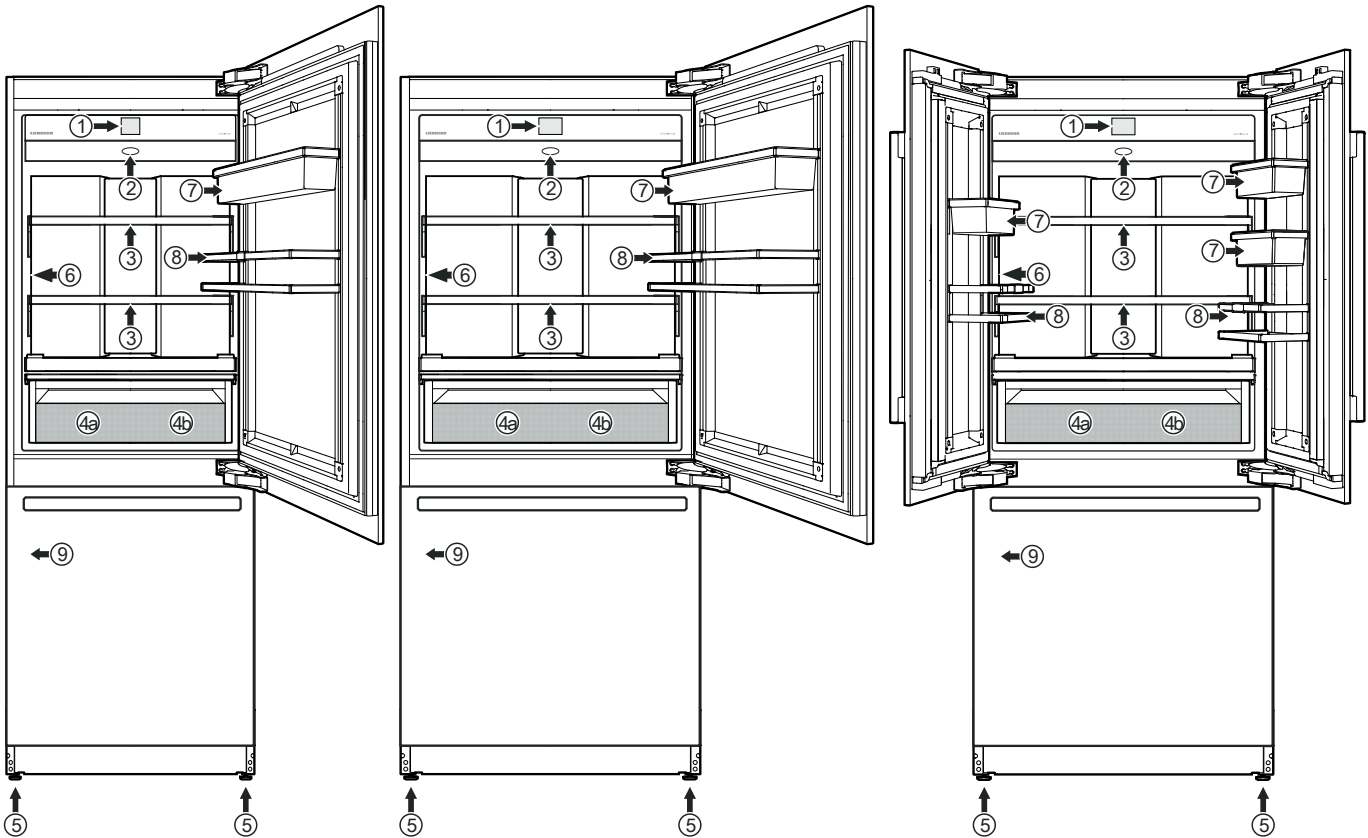

- (1) Control panel
- (2) Air filter
- (3) Adjustable shelves (max. 20 kg)
- (4a/b) BioFresh-Plus drawer. For storing food at a temperature of either 0°C or -2°C.
- (5) Adjustable-height feet
- (6) Water dispenser
- (7) Adjustable door rack
- (8) Bottle rack *
- (9) Type plate (behind the drawer on the left-hand side)
- (10) Water filter (behind the ventilation grille)
- (11) IceMaker (inside the drawer) and removable ice cube bin
- (12) Freezer drawer

} ECBN 9471 /ECBN.. 97.. (max. 25 kg)
 } ECBN 9671 /ECBN.. 99.1 (max. 30 kg)
 } ECBN 9673 /ECBN.. 99.3 (max. 15+15 kg)

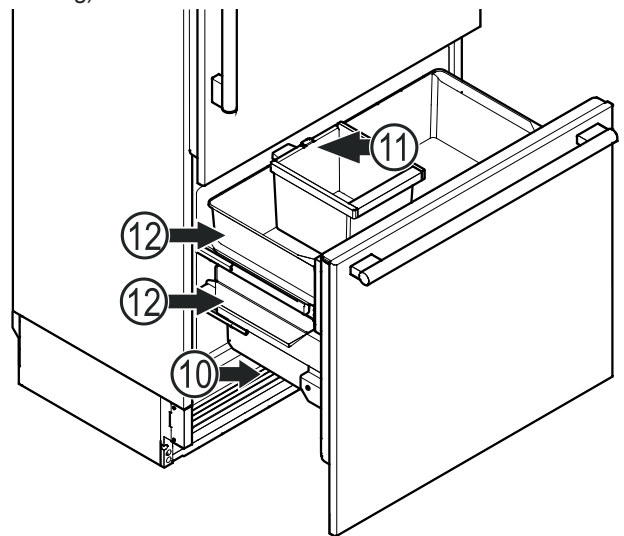

* Depending on model and options

Control panel

Three different actions to operate the control panel.

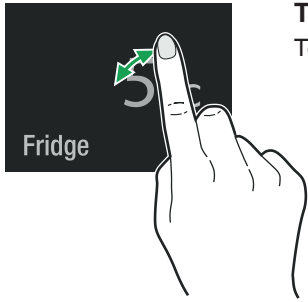

Touch

Touch to activate functions.

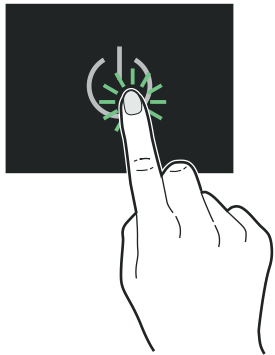

Press

Press for approx. 2 seconds to activate functions.

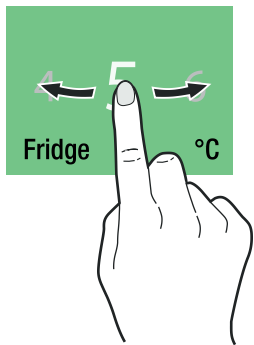

Slide

Slide to right or left to navigate in the menu or to search for values.

Switching the appliance on

Touch

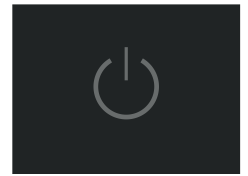

Slide to your language and touch



Available languages:

- German
- Portuguese (Brazil)
- French
- Spanish
- Italian
- English (GB)
- English (US)
- Chinese
- Russian

Slide to the desired temperature unit and touch

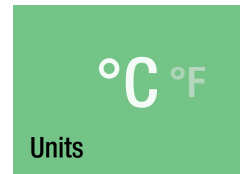
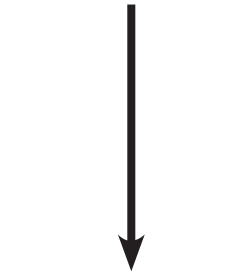

Touch to confirm or slide to the right to change the previous settings again.

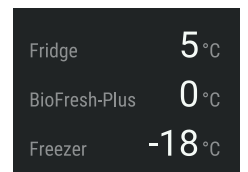
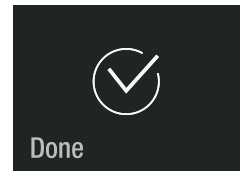





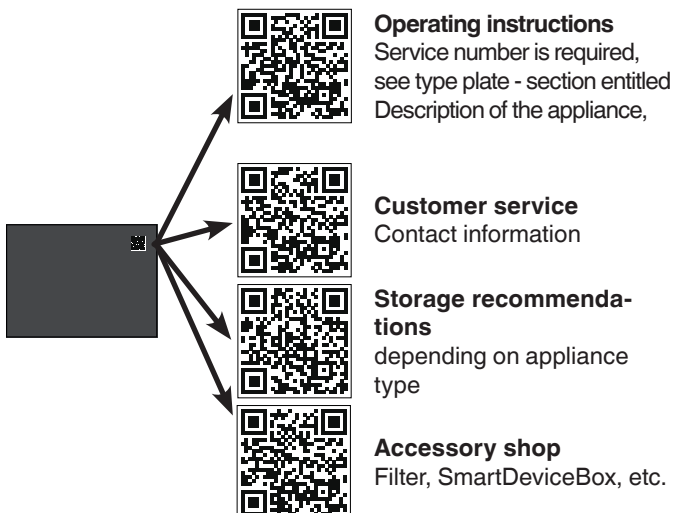





Fast access to information

(models ECBN.. 97../99.. only)



Main menu

Navigation through the main menu. The following functions are available.

 Fridge	Refrigerator compartment temperature display and temperature setting.
 BioFresh-Plus	BioFresh-Plus compartment temperature display and temperature setting.
 Freezer	Freezer compartment temperature display and temperature setting.
 SuperCool	For maximum cooling with time limit and automatic return to normal operating mode.
 SuperFrost	To freeze fresh food as rapidly as possible to ensure that the nutritional value, appearance and flavour of the food remain intact.
 IceMaker	To switch the IceMaker on or off and to maximum ice production.
 PartyMode	For permanent maximum cooling.
 HolidayMode	Switches the appliance to an energy-saving operating mode; the temperature in the refrigerator compartment is increased to 15°C.
 SabbathMode	Appliance operating mode for Sabbath and holidays. Complies with STAR-K Kosher Certification.
 	Switching the appliance on or off.

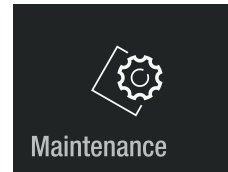

Describes how to change the filters and clean the water dispenser and dust filter.

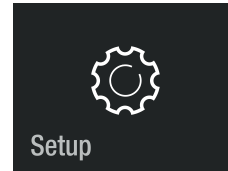

Allows the adjustment of display brightness and includes the appliance information (service number, model name, serial number).

Note

The temperature in the appliance's compartments may rise significantly if the door is left open for a lengthy period.

Setting the temperature

Slide to the desired zone.
Touch

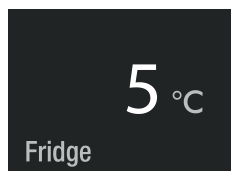

or



or

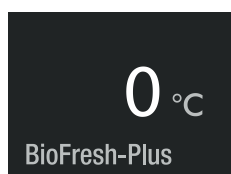

Note

The temperature in the warmest section of the appliance may be higher than the set value.

Setting the temperature (refrigerator compartment)

Standard setting is 5 °C.

Touch

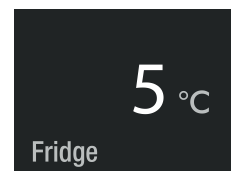

Slide to the desired target temperature and touch.



The number flashing at the bottom right shows the actual interior temperature. It disappears when the target temperature is reached.

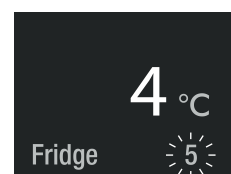

Close the appliance door.

Display when the door is opened again.

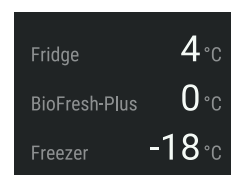

The refrigerator temperature display flashes if the actual refrigerator temperature is different to the target temperature. It stops flashing when the target temperature is reached.

The temperature can be set between 2°C and 7°C.

Setting the temperature (freezer compartment)

Standard setting is -18°C.

Touch



Slide to the desired target temperature and touch.

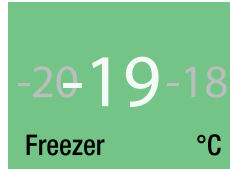

The number flashing at the bottom right shows the actual interior temperature. It disappears when the target temperature is reached.



Close the appliance door.

Display when the door is opened again.



The temperature display flashes if the actual interior temperature is different to the target temperature. It stops flashing when the target temperature is reached.

The temperature can be set at between -14°C and -27°C.

Setting the temperature (BioFresh-Plus compartment)

Standard setting is 0°C.

Touch

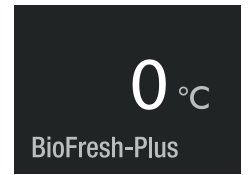

Slide to the desired target temperature and touch.

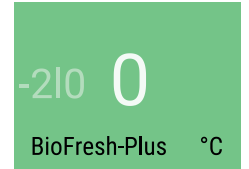

or

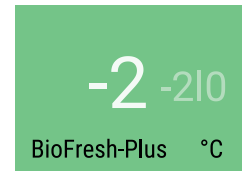

or

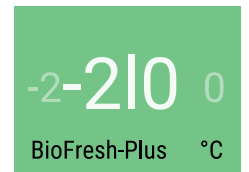

An additional drawer divider must be inserted to select -2°C/0°C.

Temperature range on the left-hand side of the drawer: -2°C
Temperature range on the right-hand side of the drawer: 0°C

Note

There is no need to remove the drawer divider for setting to 0°C or -2°C. The temperature will be adjusted in both compartments of the drawer.

For dual temperature please ensure the drawer divider is inserted.



Pull the drawer straight out, grip at the back and lift out.

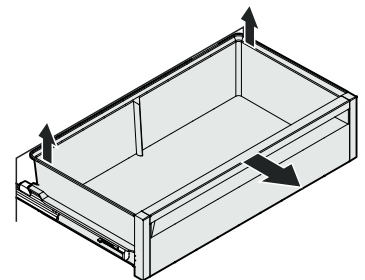

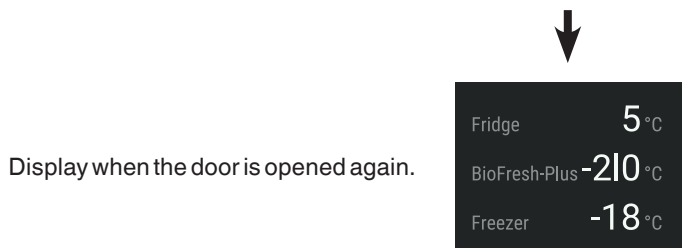
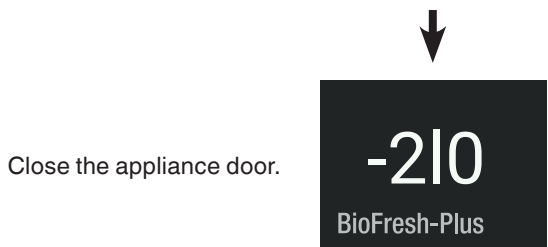
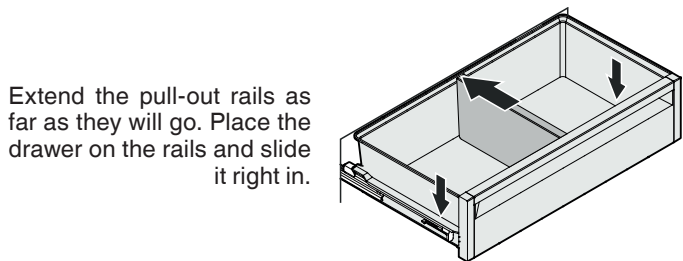
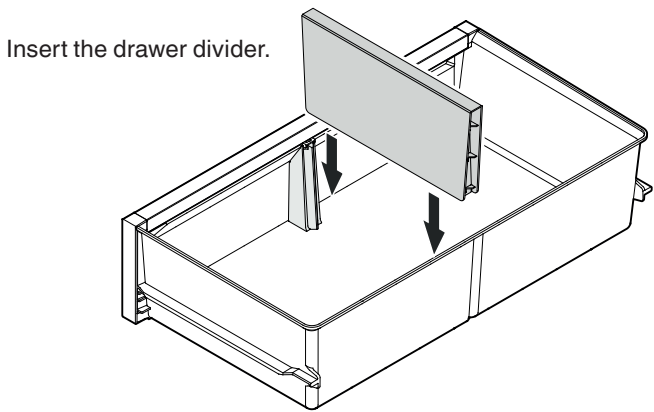
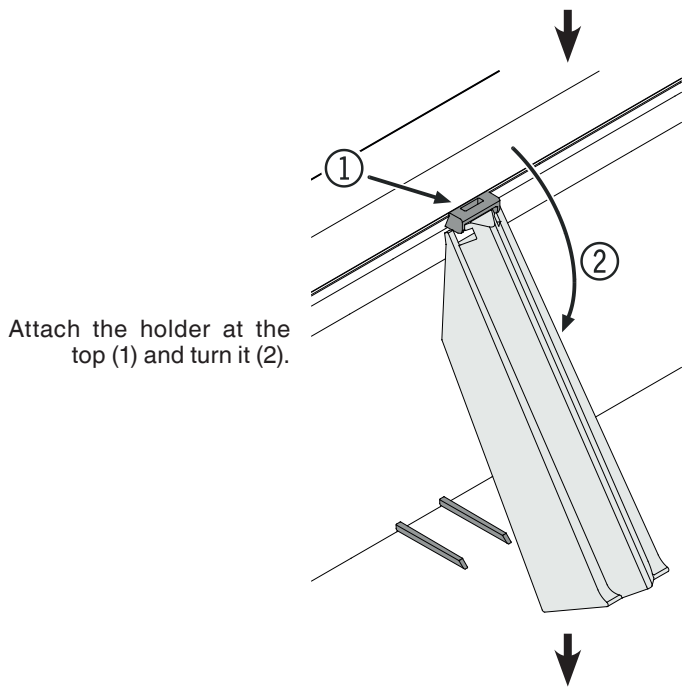

SuperCool

Activate SuperCool if you wish to cool large quantities of food rapidly. The set temperature is 2°C.

Touch

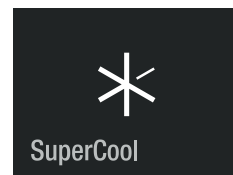

SuperCool is activated. At the top right, the remaining run time of 6 hours is visible. When this time is up, the appliance switches back to normal operation.

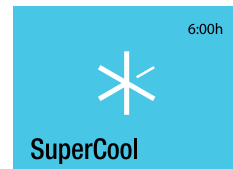

Close the appliance door.

Display when the door is opened again.

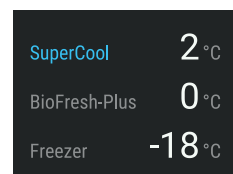

To change the temperature, SuperCool must be deactivated. Touch the display.

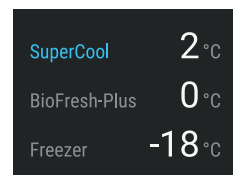

Touch

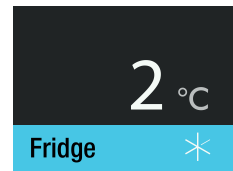

Touch

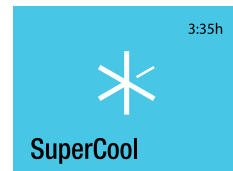

SuperCool is deactivated.

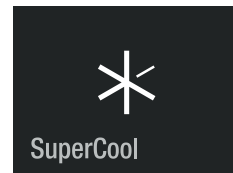

SuperFrost

Fresh food should be frozen completely and as rapidly as possible. This is provided by the SuperFrost feature and ensures that the nutritional value, appearance and flavor of the food remains intact.

The maximum amount of food in kg which can be frozen in 24 hours is shown on the type plate (**Freezing capacity**).

Touch



SuperFrost is activated.

Wait 24 hours. Then place the food inside and close the appliance door.

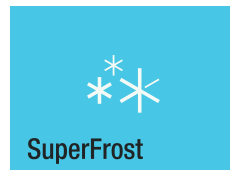

Display when the door is opened again.

The SuperFrost function switches off automatically after between 30 and 65 hours depending on the quantity of food placed inside.

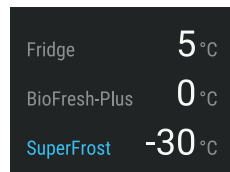

To deactivate SuperFrost earlier, touch the display.

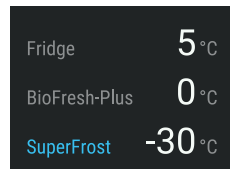

Touch

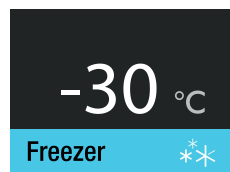

Touch

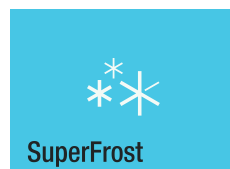

SuperFrost is deactivated.

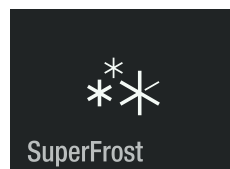

Notes on freezing

- Always store identical food items together.
- Pack food which you are freezing yourself in quantities appropriate to your household. To ensure that the food freezes right through, the following quantities should not be exceeded per package:
 - fruit, vegetables: up to 1 kg,
 - meat: up to 2.5 kg.
- Pack frozen food in standard freezer bags or reuseable plastic, metal or aluminium containers.
- Do not allow fresh food which is to be frozen to come into contact with food already frozen. Always keep packs dry in order to avoid them sticking together.
- Always write the date and contents on the pack and do not exceed the stated storage time for the food.
- Do not freeze bottles and cans which contain carbonated drinks as they might burst.
- Only take out as much food as is immediately required for thawing. Use food which has been thawed in prepared meals as quickly as possible.

Frozen food can be thawed in the following ways:

- in a fan oven
- in a microwave oven
- at room temperature
- in the refrigerator

Safety instructions and warnings for the IceMaker

- The IceMaker is designed exclusively to make ice cubes in quantities needed by a household.
- All repairs and work on the IceMaker may only be done by customer service personnel or other appropriately trained personnel.
- **Do not consume or use the first three batches of ice. This applies both to using the appliance for the first time and also using it after it has not been used for a long period of time.**
- **The manufacturer cannot accept liability for damage caused by equipment or water lines between the solenoid valve and the water supply.**

IceMaker description

The IceMaker is in the top drawer of the appliance.

The ice cubes fall out of the IceMaker into the drawer.

When the ice reaches a certain level in the drawer, the appliance stops producing ice automatically.

After you start the IceMaker for the first time, it may take up to 24 hours before the first ice cubes are ready.

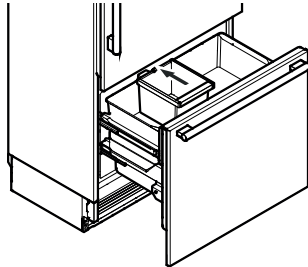

Note

The first three batches of ice must not be consumed or used.

Switching the IceMaker on

Touch

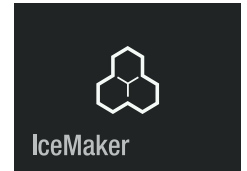

Slide to the left.

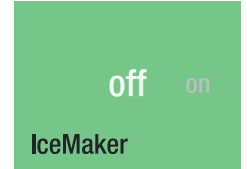

Touch

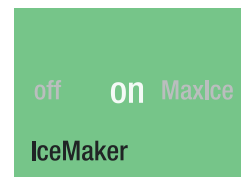

The IceMaker is switched on.



The production capacity is 100 to 120 ice cubes in 24 hours at a temperature of -18°C in the freezer compartment.

Switching the IceMaker off

Note

Additional steps required to decommission the appliance or for a lengthy absence.

- Switch off the water supply.
- Wait for 24 hours or until the water alarm appears.
- Disable the IceMaker.

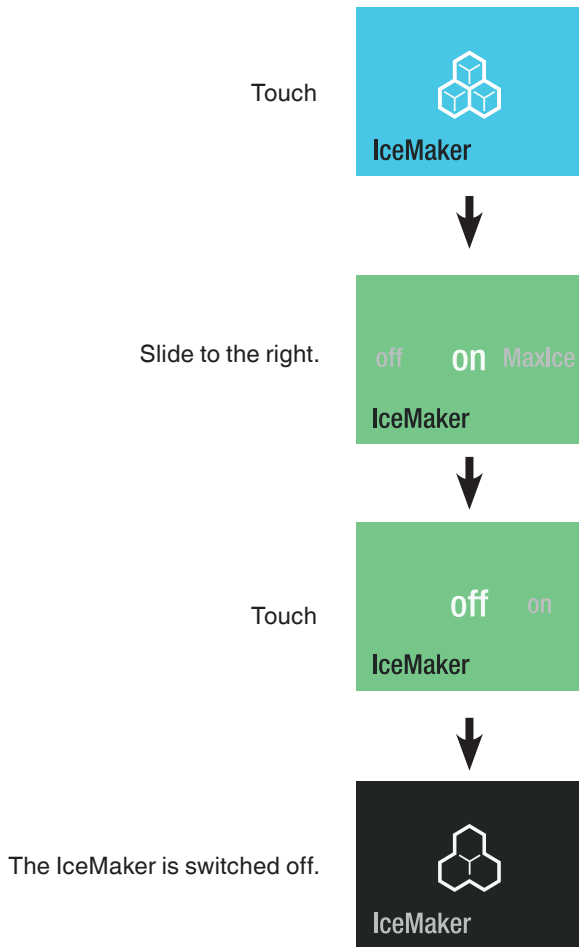

Switching the IceMaker to maximum ice production

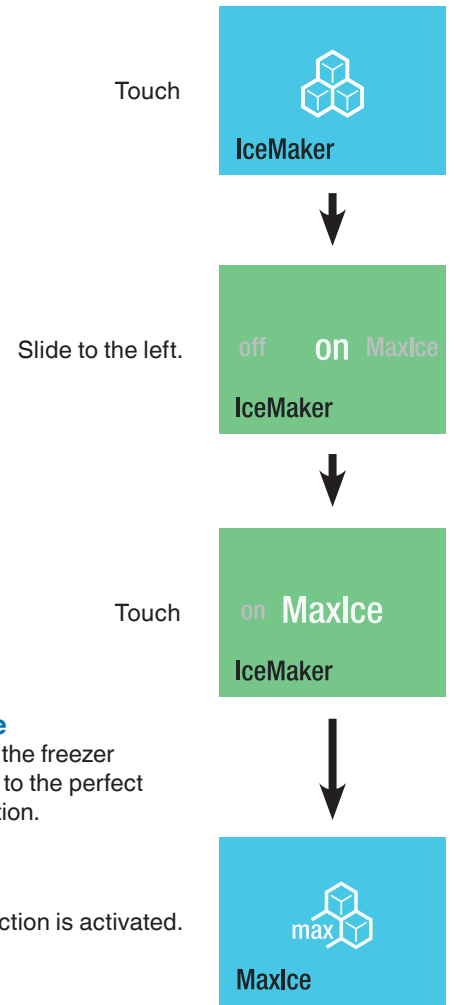

Note

The temperature in the freezer compartment is set to the perfect level for ice production.

The MaxIce function is activated.

Note

Maximum ice production is switched off after 36 hours.

The production capacity is approx. 150 ice cubes in 24 hours.

Be aware that this increases the energy consumption slightly.

PartyMode

When a large amount of cold food or beverages is needed: place all the food and beverages in the appliance one day before and activate PartyMode. SuperCool is activated in the refrigerator compartment and maximum ice production in the freezer compartment.

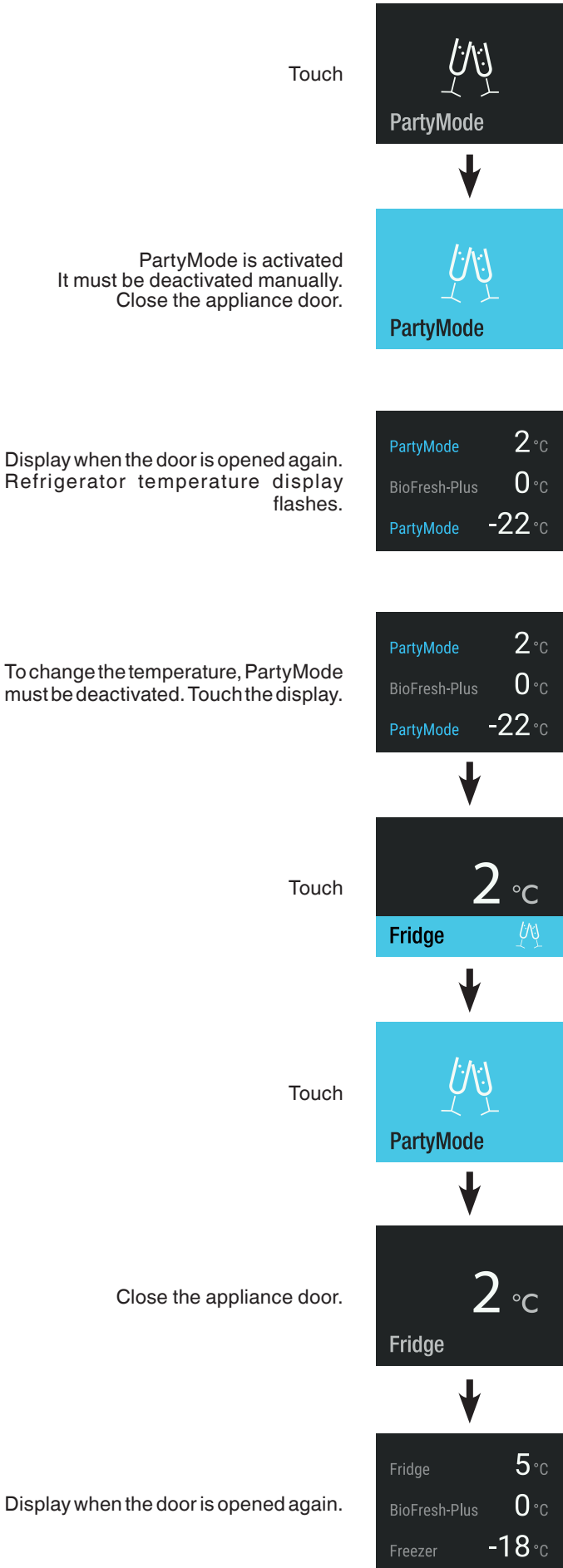

HolidayMode

Before a lengthy absence, use up all the food in the refrigerator compartment and activate HolidayMode. This ensures that no unpleasant odours develop inside the appliance, even if the appliance door is closed. (The temperature in the refrigerator compartment is increased to 15°C.) The current cycle for ice cubes will be completed in the freezer compartment and the IceMaker will be disabled.

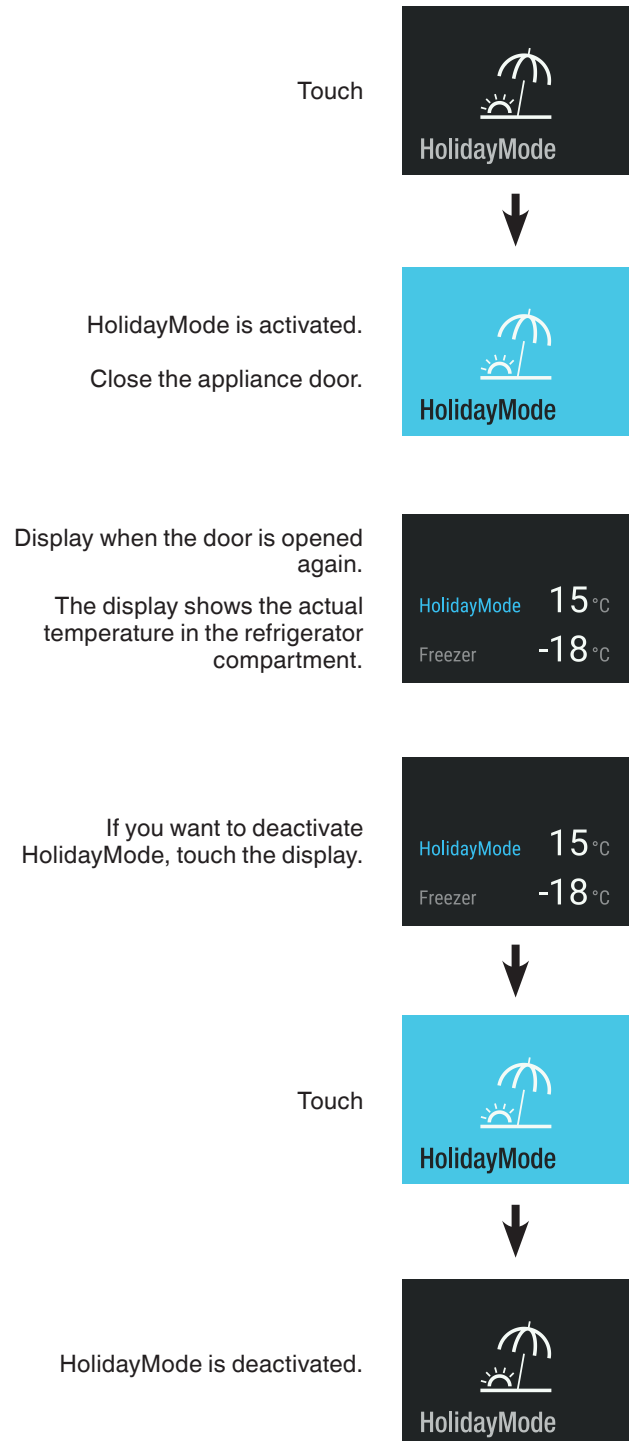

SabbathMode

When SabbathMode is active, some electronic functions are switched off to comply with STAR-K Kosher Certification.

- The lighting remains off.
- The cooling fan remains in its actual state: if it is on, it remains on; if it is off, it remains off.
- There is no door alarm.
- There is no temperature alarm.
- Defrost cycles are independent of the number of times and length of door openings.
- The appliance will return to SabbathMode after a power failure.

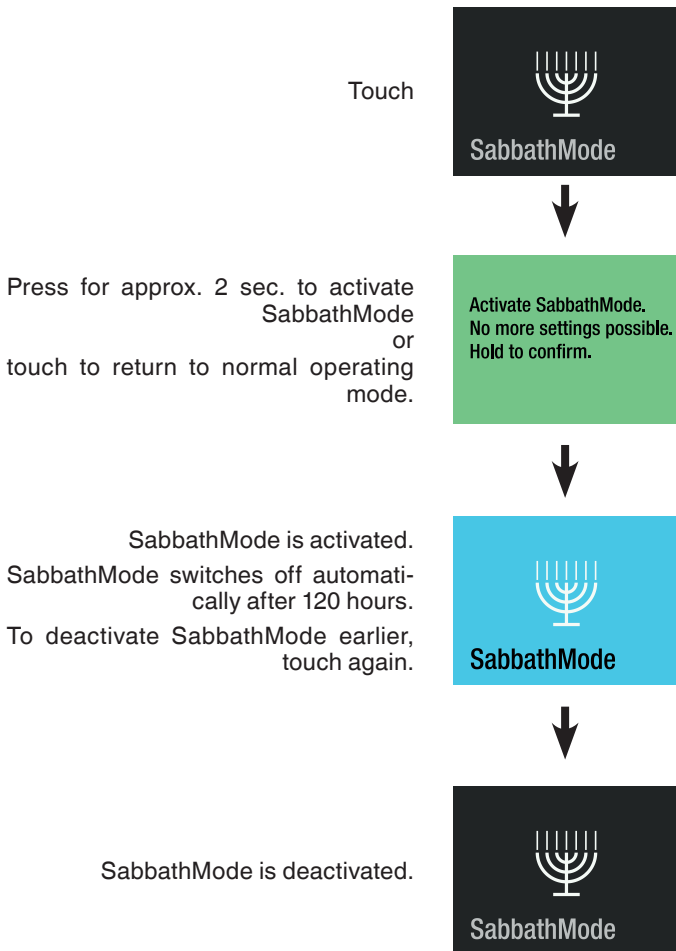

Switching the appliance off

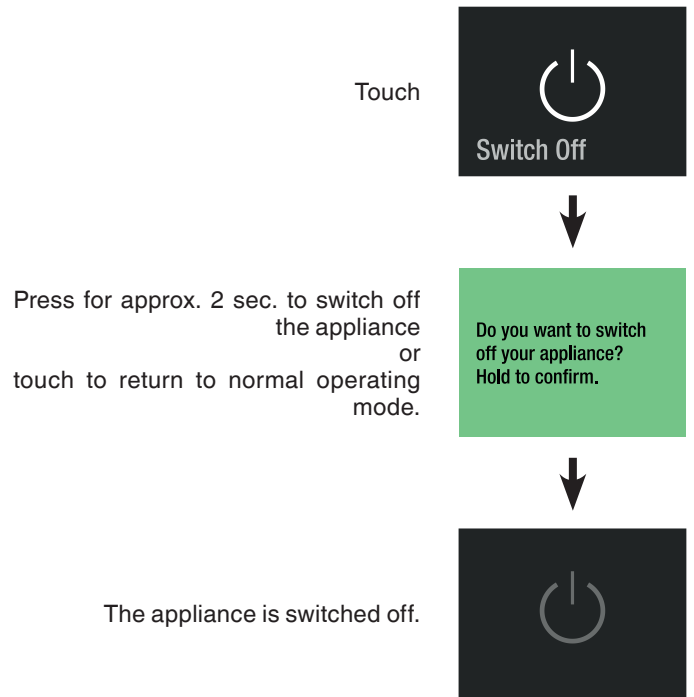

Maintenance message

In regular intervals of operation of the appliance, the maintenance message comes on (6 months). Filters need to be changed. The water dispenser needs to be flushed. The dust filter needs to be cleaned.

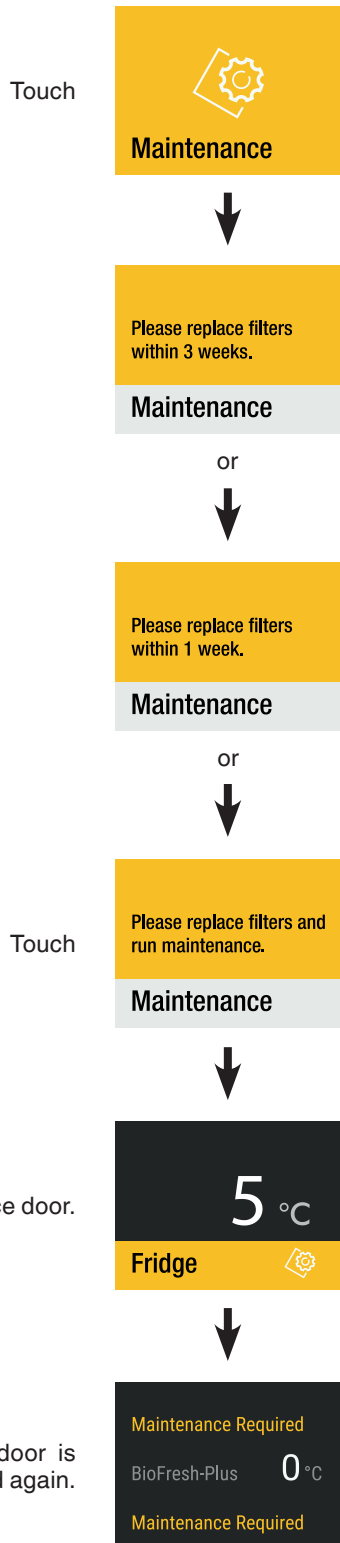

Close the appliance door.

Display when the appliance door is opened again.

Obtain water filter and air filter from your dealer and complete the maintenance procedure.

Maintenance confirmation

Note

Remove ice cubes from the IceMaker before starting maintenance.

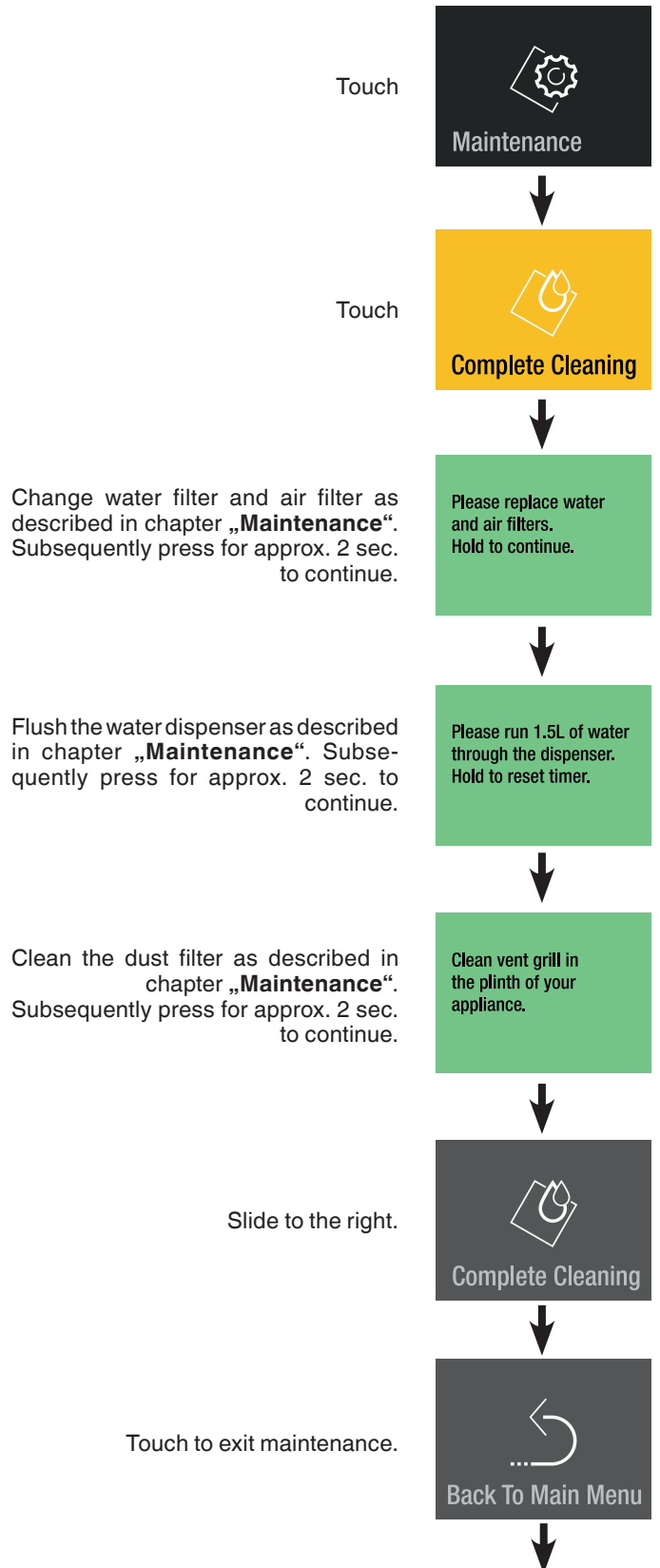

Touch

Touch

Change water filter and air filter as described in chapter „Maintenance“. Subsequently press for approx. 2 sec. to continue.

Flush the water dispenser as described in chapter „Maintenance“. Subsequently press for approx. 2 sec. to continue.

Clean the dust filter as described in chapter „Maintenance“. Subsequently press for approx. 2 sec. to continue.

Slide to the right.

Touch to exit maintenance.

Note

The first three batches of ice must not be consumed or used, a reminder appears.

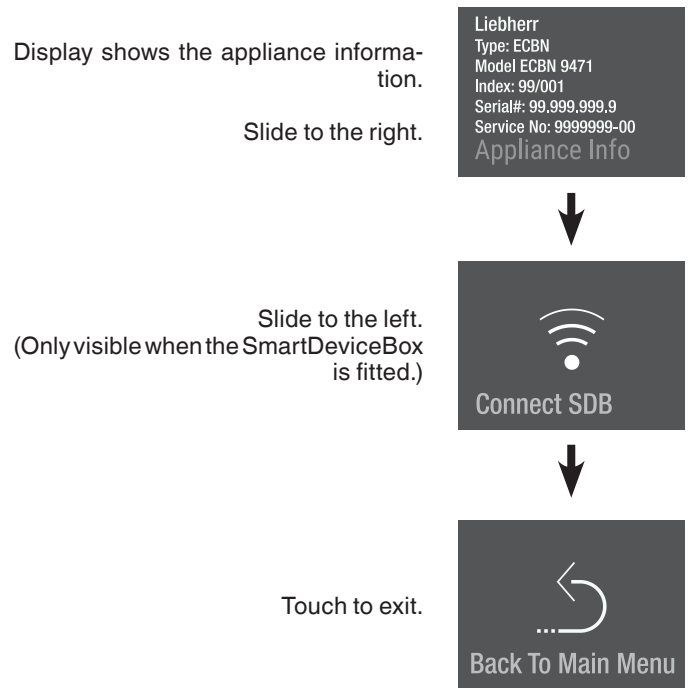
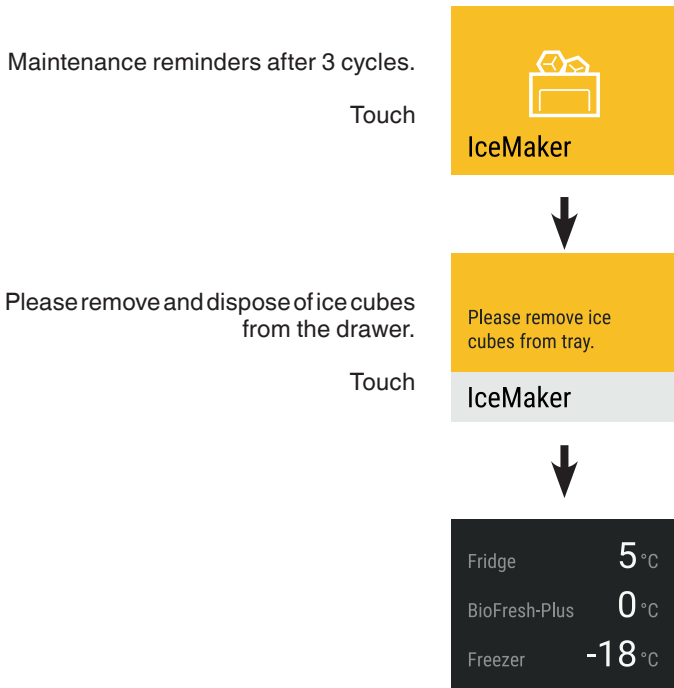

Setup menu

Includes the adjustment for display brightness, language, units, activation of the SmartDeviceBox and the appliance information.

Display brightness

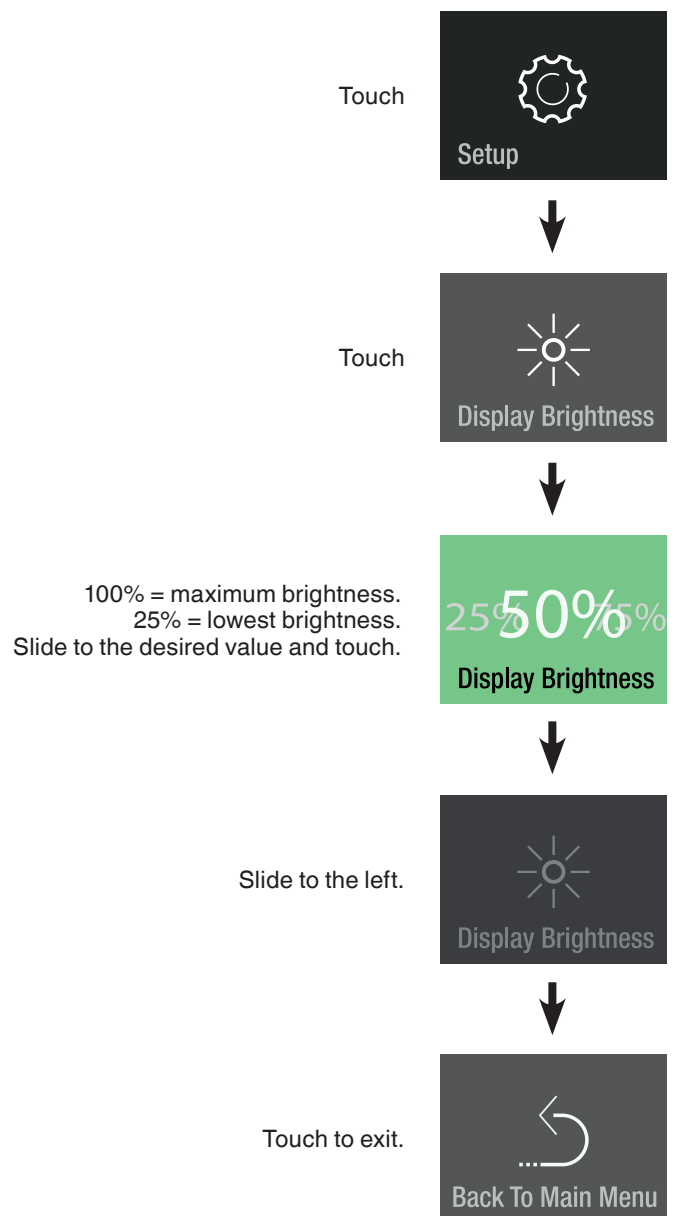
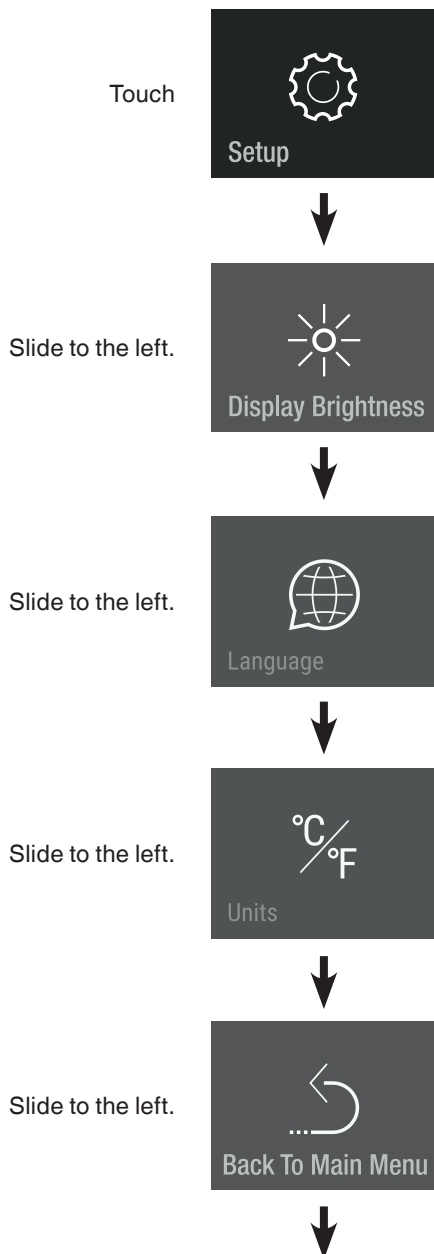

Language

Touch



Slide to your language and touch



Available languages:

- German
- Portuguese (Brazil)
- French
- Spanish
- Italian
- English (GB)
- English (US)
- Chinese
- Russian

Slide twice to the left.

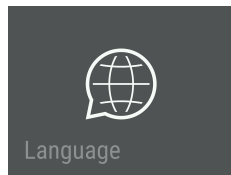

Touch to exit.

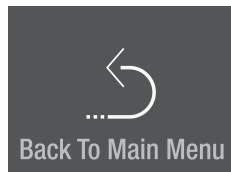

Units

Touch

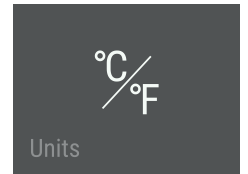

Slide to the desired temperature unit and touch

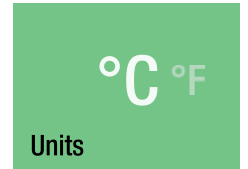

Slide to the left.

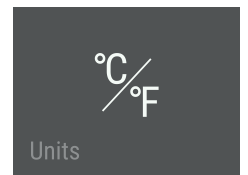

Touch to exit.

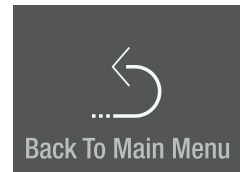

SmartDeviceBox (not supplied in all countries)

The appliance is ready for integration into a smart home system and for extended services.

You will find more information about availability and prerequisites and the individual options on the website smartdevice.liebherr.com.



Download the "SmartDevice" app to your mobile device.

Start the app on your mobile device and follow the instructions.

SmartDevice functions are not available in all countries.

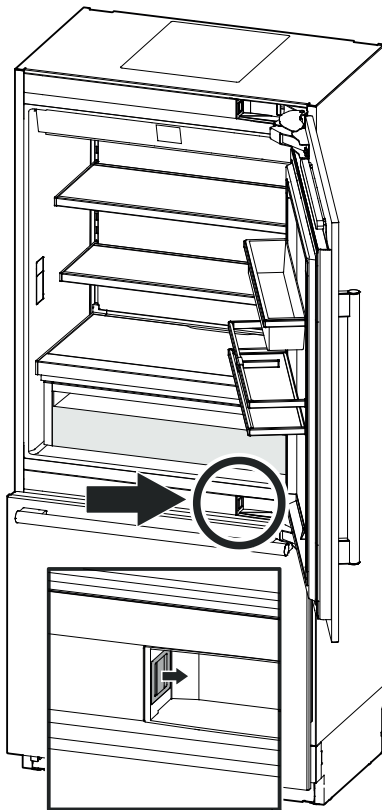

Description of the SmartDevice display

SmartDeviceBox is inserted.

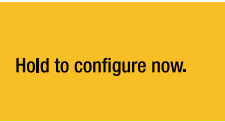

Display to start the WLAN connection.



The symbol flashes.

Connection to WLAN is in progress.



The router credentials are displayed.

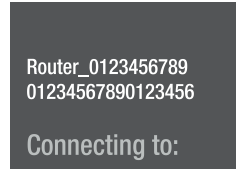

Appliance is connected to WLAN.



Connection reset.

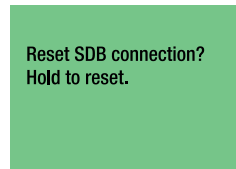

This message informs you of any router or Internet problems.



Alarm messages

Door open alarm

Door has been left open for longer than 60 seconds.

Action
Close the appliance door.



Electronic fault alarm

Electronic fault.
Touch



Action
Contact the customer service department, stating the failure code displayed.

Touch



Touch

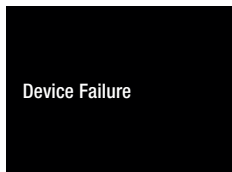

Press for approx. 2 seconds to read failure code again.



Temperature alarm

Touch



The interior temperature was too high.

Touch



Touch

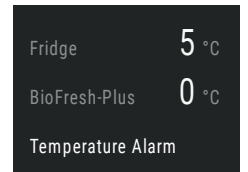

Action
Check the quality of the stored food.
The alarm display disappears as soon as the set temperature is reached.



Water alarm

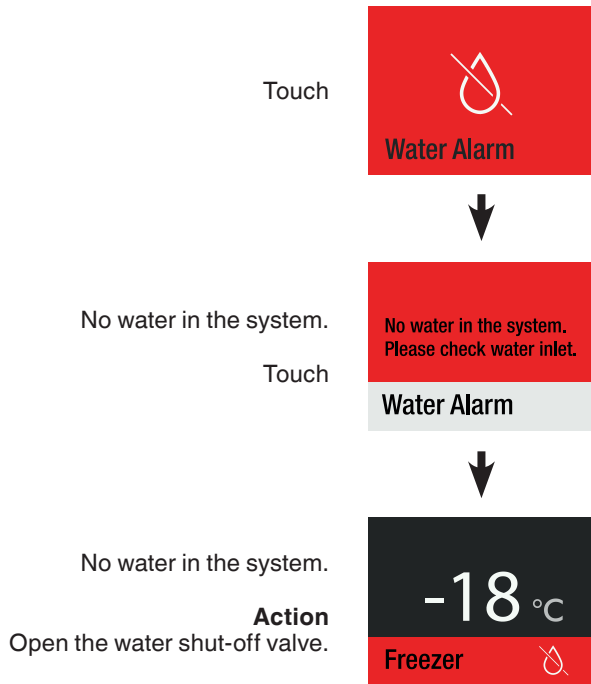

Power alarm

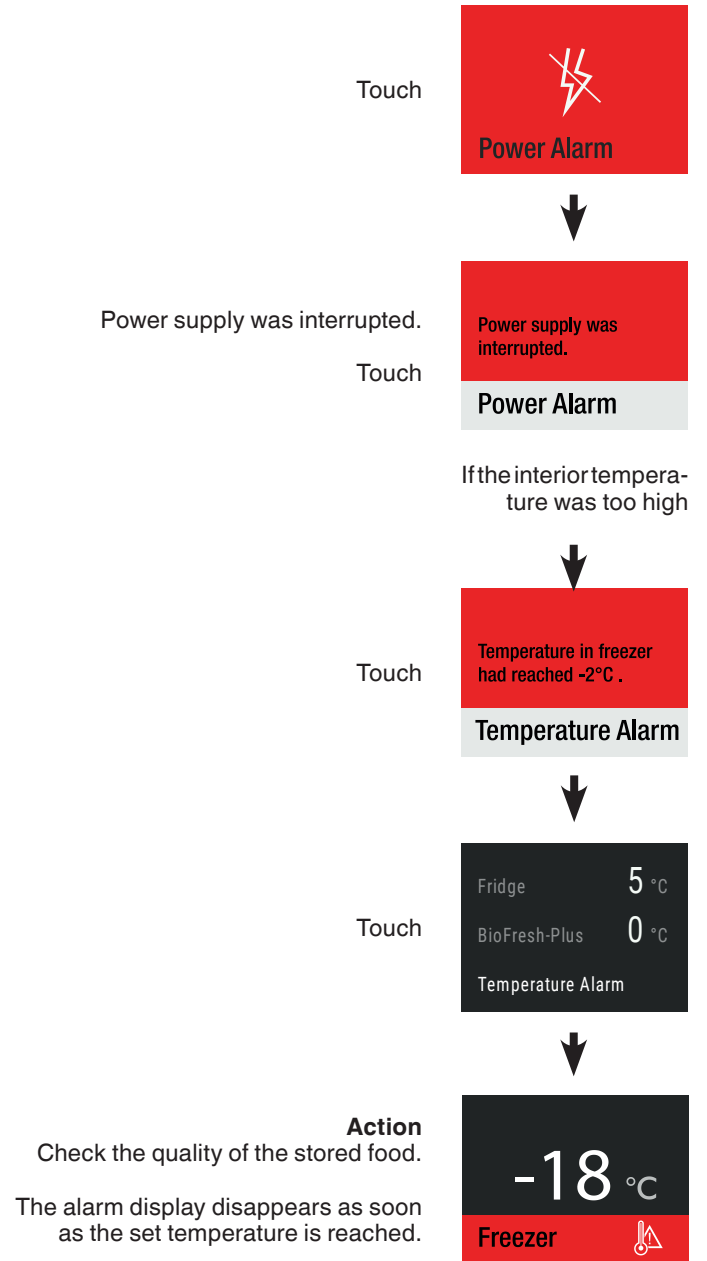

IceMaker alarm

Touch



Action

Contact the customer service department, stating the failure code displayed.



Touch

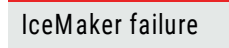

The IceMaker is disabled. There is no need to move any items to another appliance.



The menu will continue to show the "IceMaker failure" error until it has been rectified by the customer service team.



Connection failure

Touch



Action

Contact the customer service department, stating the failure code displayed.

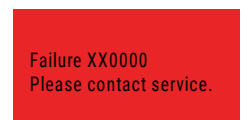

Touch



The connection is disabled. There is no need to move any items to another appliance.



The menu will continue to show the "Connection failure" error until it has been rectified by the customer service team.



Equipment

You can position the shelves and door racks at different heights as required.



Risk of injury and damage.

Do not attempt to adjust a shelf or door rack with food on it.

Only adjust an empty shelf or door rack.

Repositioning the shelves

Removing

Lift the shelf up and remove.

Installing

Insert the hooks of the shelf into the openings of the clip-in strip at the desired height and push down.

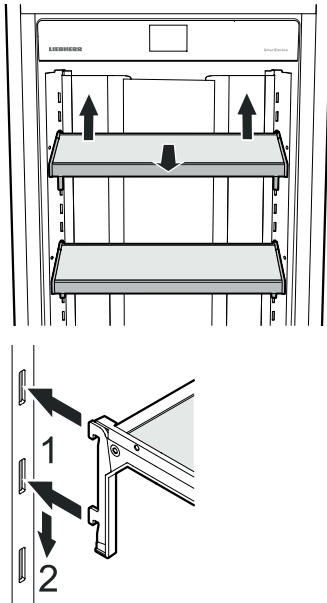

Repositioning the door racks

Removing

Lift the rack up and remove.

Installing

Insert the hooks of the rack into the openings of the clip-in strip at the desired height and push down.

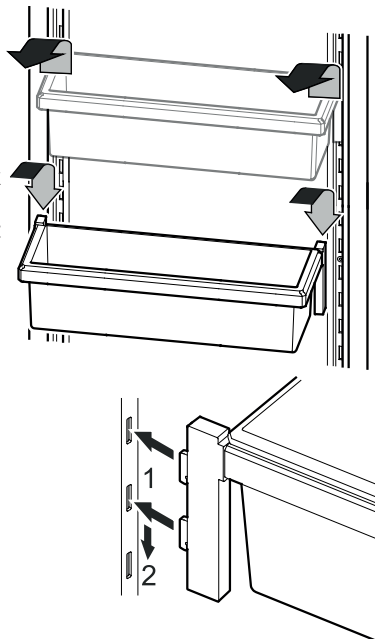

Bottle holder *

You can protect the bottles from falling over when the door is opened and closed.

Move the bottle holder to the desired position.

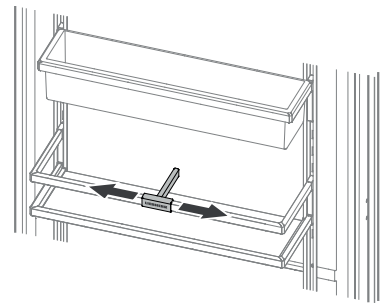

Bottle tray

The tray above the BioFresh drawers can be used for storing bottles horizontally.

Remove glass plate.

Note

When storing tall bottles (higher than 230 mm), the bottle rack must be relocated to a higher position to avoid collision.

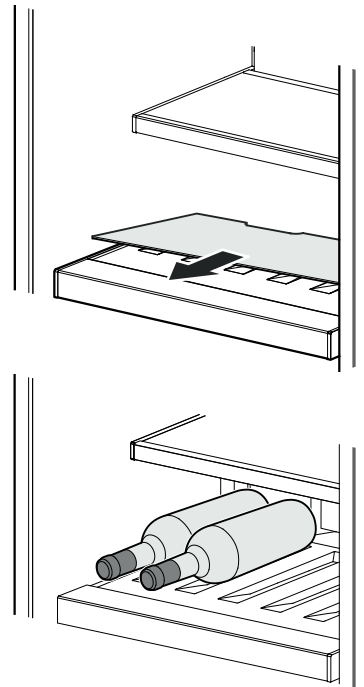

Water dispenser

Press a drinking glass against the bottom part of the dispenser. The top part moves out and the water flows into the glass.

(max. actuation duration 2 minutes → waiting time before reuse 4 minutes)

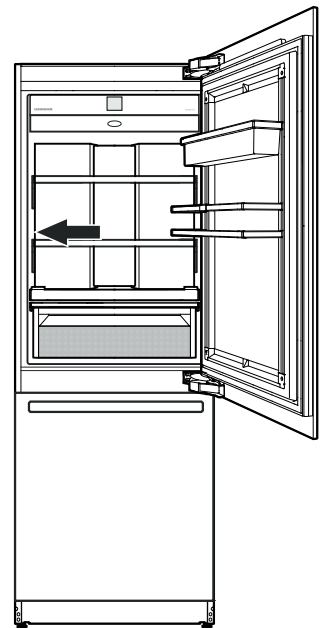
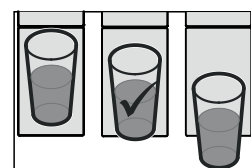
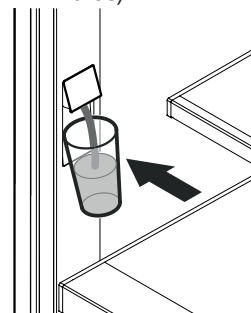

Note

The water temperature is determined by the appliance setting and the water intake temperature.

* Depending on model and options

BioFresh-Plus compartment

Set the temperature of the BioFresh-Plus compartment in accordance with the type of stored food. See chapter „Setting the temperature (BioFresh-Plus compartment)“

Set to 0°C (factory setting) for storing fruit, vegetables, meat, cold meats or dairy products.

Set to -2°C for storing fish or seafood. Storage time is 3 days at the most.

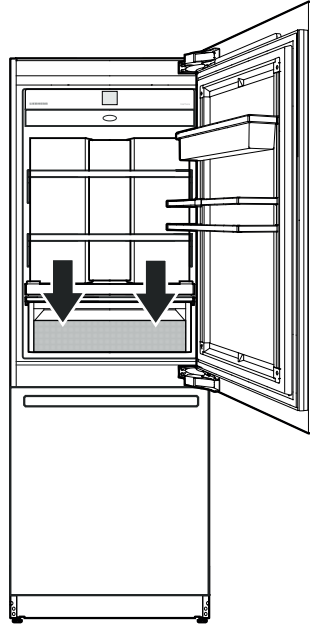

Notes

- The humidity in the compartment depends on the moisture content of the food and the frequency with which a drawer is opened.
- The fresher the product and the higher its quality, the longer the storage life.
- Unwrapped animal and vegetable foods should be stored separately in the drawers. If there is not enough space for them to be stored separately, make sure that they are wrapped. Do not allow different types of meat to come into contact with one another but keep them packaged separately so as to avoid premature bacterial spoilage.
- The following products should not be stored in the BioFresh-Plus compartment: hard cheese, potatoes, cold-sensitive vegetables such as cucumber, aubergines, avocados, semi-ripe tomatoes, courgettes and all cold-sensitive tropical fruits such as pineapples, bananas, grapefruit, melons, mangos, papayas, etc.

Cleaning



- To prevent possible injury due to an electric shock, be sure to disconnect the mains cable or switch off the fuse before cleaning the appliance.
- To avoid injury or damage, do not use steam cleaning equipment to clean the appliance.
- To avoid short-circuits, ensure no cleaning water penetrates into the electrical components when cleaning the appliance. Do not use a sponge or cloth that is overly wet.
- Surfaces which may come into contact with food and accessible drain systems must be cleaned at regular intervals.
- Take food out of the appliance and store it in a cool place.
- Rinse or flush the water system after 5 days if it has not been used, refer to chapter „Maintenance menu“.

Remove the glass shelves and door racks. Refer to chapter „Equipment“.

- Remove the drawers.

Pull the drawer straight out, grip at the back and lift out.

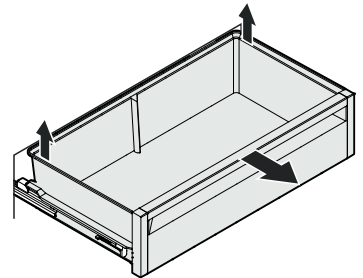

- Pull the freezer drawer upwards by its right and left bottom corners (1). Push the container backwards (2). Set the container to an angle and remove it (3).

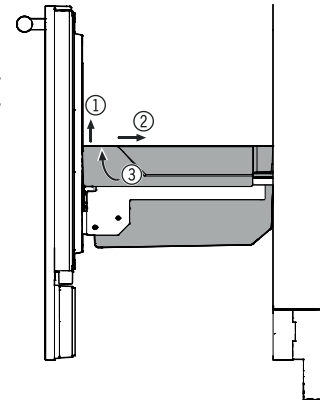

- The bottommost freezer drawer must be removed to clean the glass plate in the freezer compartment.

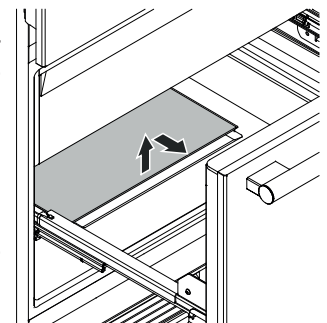

- Clean the inside of the appliance and equipment parts with lukewarm water and a little detergent.

Note

Do not use abrasive sponges or scourers, do not use concentrated cleaning agents and never use cleaning agents containing sand, chloride or acid or chemical solvents.

- Clean the pull-out rails with a slightly dampened cloth only.

Note

No cleaning water must be allowed to get into the pull-out rail guides.

- Dry all parts well with a cloth.
- Do not damage or remove the type plate on the inside of the appliance. It is very important for servicing purposes.

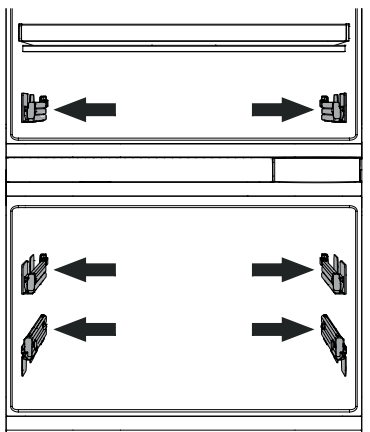

- Install the drawers.
- Extend the pull-out rails as far as they will go. Place the drawer on the rails and slide it right in.

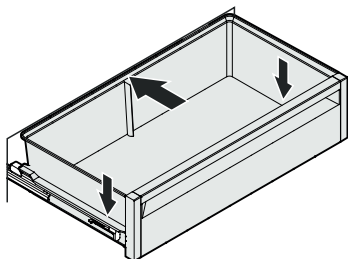

- Install all equipment parts and replace the food in the appliance. Refer to chapter „**Equipment**“.
- Switch the appliance on.

Maintenance menu

Maintenance can be carried out independently of the specified regular intervals. The maintenance menu includes the following steps.

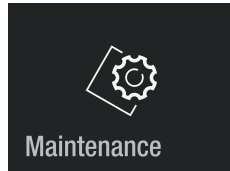

Complete cleaning
For complete maintenance of the appliance.

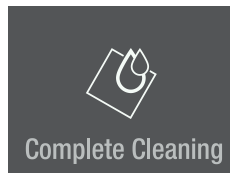

→ Please replace water and air filters.
Hold to continue.

→ Please run 1.5L of water through the dispenser.
Hold to reset timer.

→ Clean vent grill in the plinth of your appliance.

Clean dispenser
To interrupt the water supply for cleaning the dispenser outlet.



→ Please clean water dispenser.
Hold to activate water dispenser.

New water filter
To flush and reset maintenance timer.



→ Please replace water filter.
Hold To continue.

→ Please run 1.5L of water through the dispenser.
Hold to reset timer.

New air filter
To reset maintenance timer.

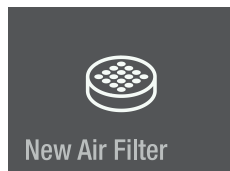

→ Please replace air filter.
Hold to reset timer.

Clean rinse
To flush the water dispenser when the dispenser has not been used for a longer period of time.

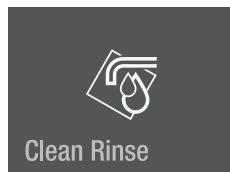

→ Please run 1.5L of water through the dispenser.

To return to the main menu.

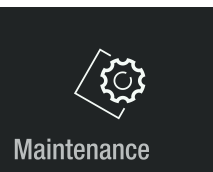
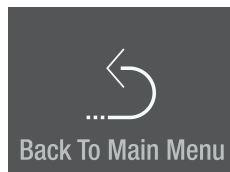

Maintenance

New water filter

The inserted water filter absorbs deposits in the water and reduces the taste of chlorine.

Note

To avoid reduction of the water flow rate of the dispenser, the water filter should be changed at least at the indicated maintenance intervals.

If noticeable water flow reduction occurs, the water filter should be changed sooner.

Note

It is not necessary to switch off the water supply when removing or inserting the filter.

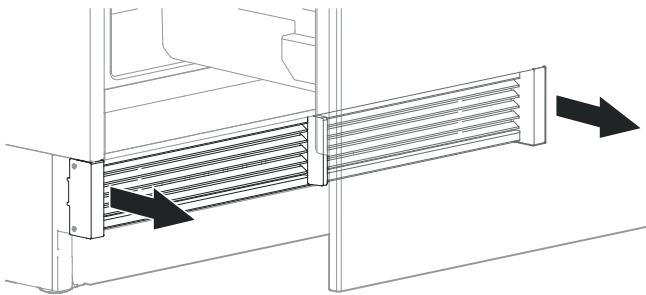

Remove the ventilation grille.

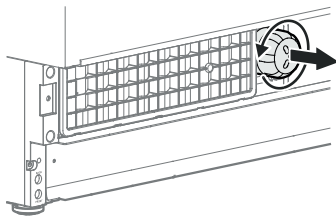

Turn the water filter anti-clockwise and remove it.

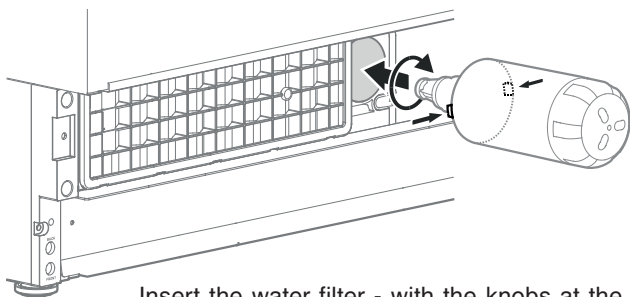

Insert the water filter - with the knobs at the front in a horizontal position - as far as it will go and turn clockwise until it snaps in.

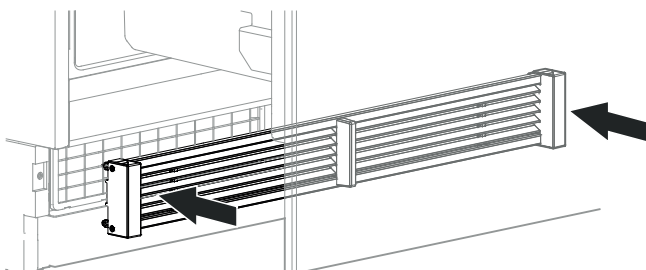

Mount the ventilation grille.

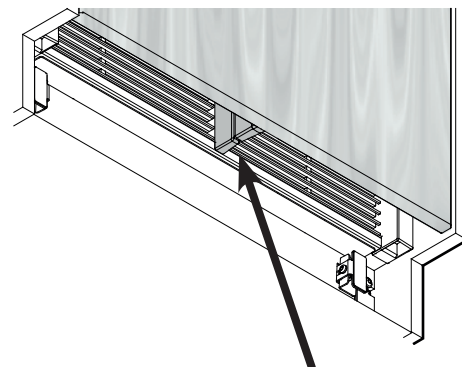

Check that there is no gap between the appliance air divider and the door air divider.

Note

There will be a gap if the ventilation grille is fitted incorrectly.

Touch



Press for approx. 2 sec.

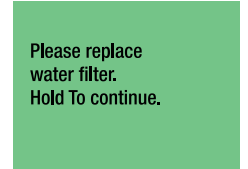

Press for approx. 2 sec.

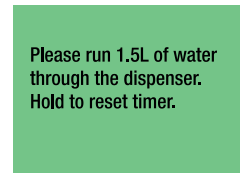

Flush approx. 1.5 l of water through the dispenser and discard.

The timer for water filter change is reset.

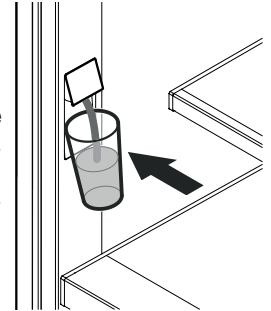

Slide 3 times to the left.



Touch to exit the menu.

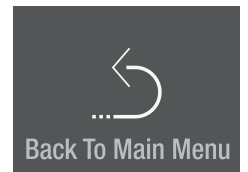

Dispenser cleaning

The dispenser outlet and the surrounding area can be cleaned without disconnecting the appliance from the electrical power supply.



Message

The water supply is stopped now.

Please clean water dispenser. Hold to activate water dispenser.

- Press in the bottom part of the dispenser so that the top part moves out.
- Clean the water outlet and the surrounding area.
- Release the bottom part of the dispenser.

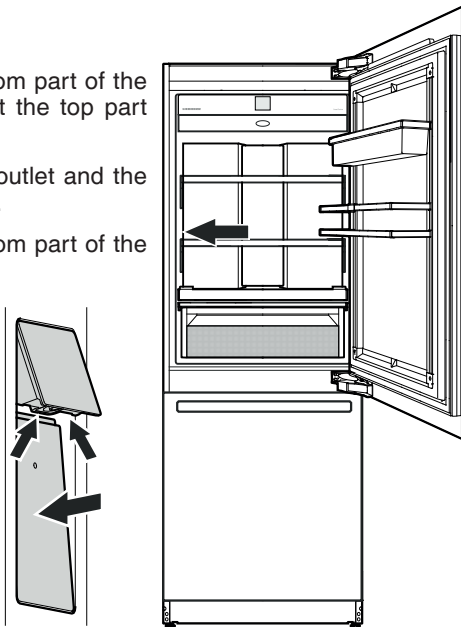

Press for approx. 2 sec.

Please clean water dispenser. Hold to activate water dispenser.



The water dispenser is ready for use again.

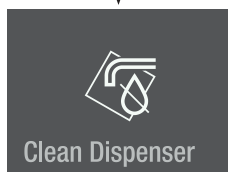

If the water flow is no longer even, the aerator must be replaced (see contact details on the back of this manual).

New air filter

The air filter absorbs odours from the appliance interior. It should be changed at least at the indicated maintenance intervals.



Message

Please replace air filter. Hold to reset timer.

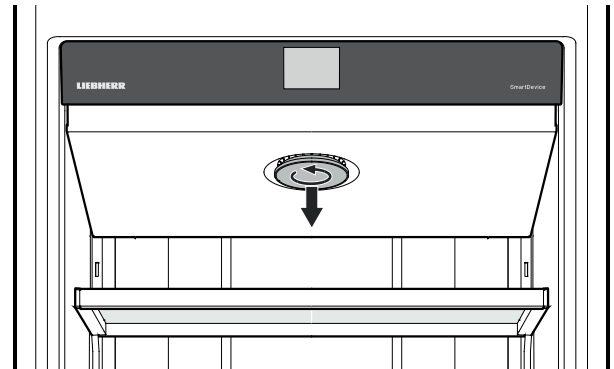

Turn the cover anticlockwise and remove it.

Turn the air filter anti-clockwise and remove it.

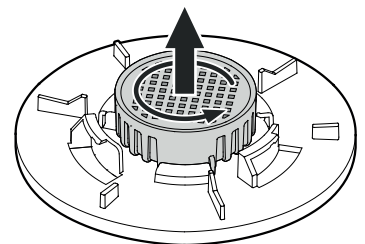

Insert the new air filter and turn clockwise until it snaps in.

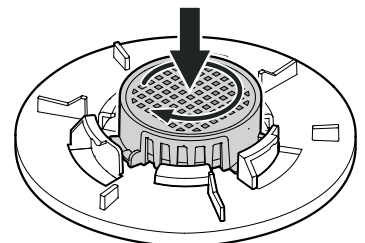

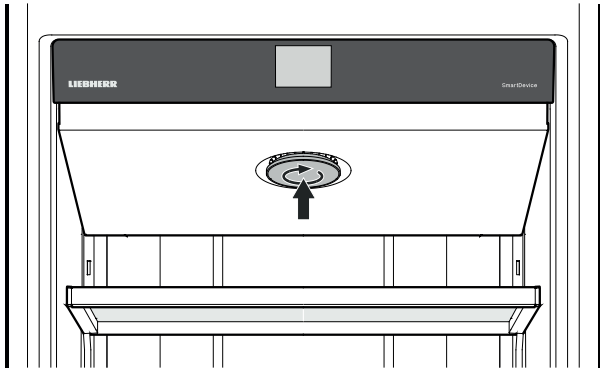

Insert the cover and turn clockwise until it snaps in.

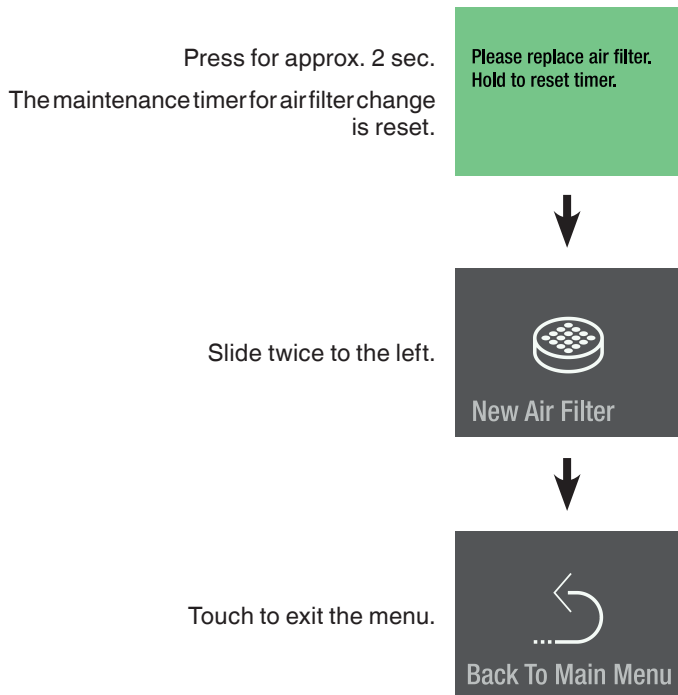

Clean rinse

When the water dispenser has not been used for one week or more, flush the pipeline.

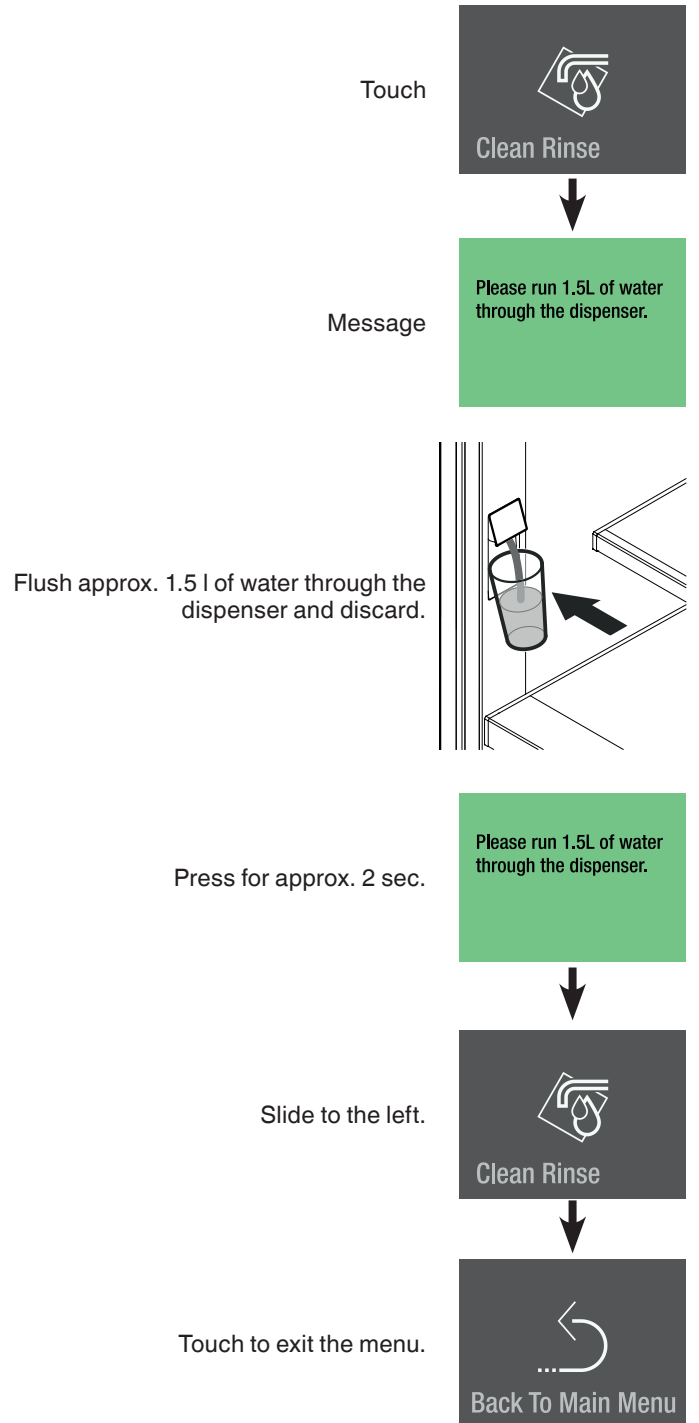

Cleaning the dust filter

Clean the dust filter in the plinth area at least at the indicated maintenance intervals.

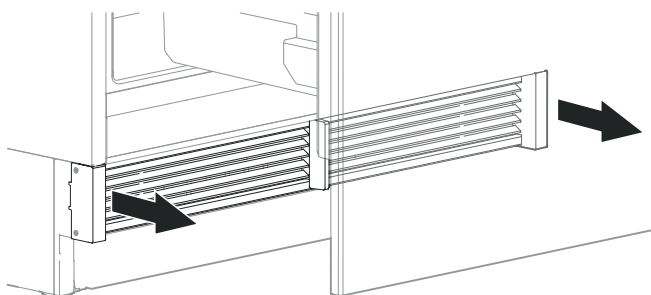

Remove the ventilation grille.

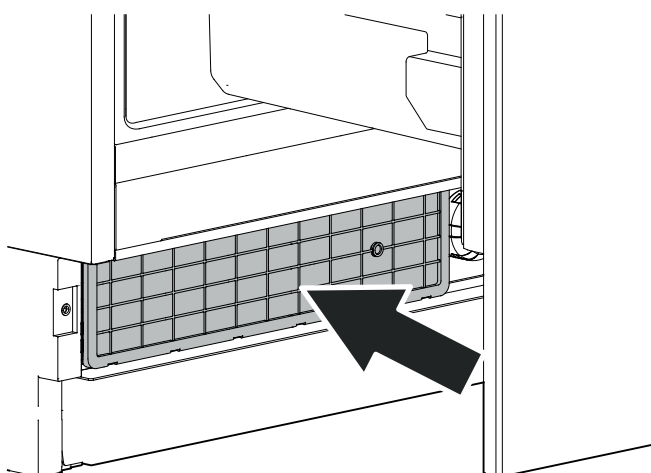

Clean the dust filter with a vacuum cleaner.

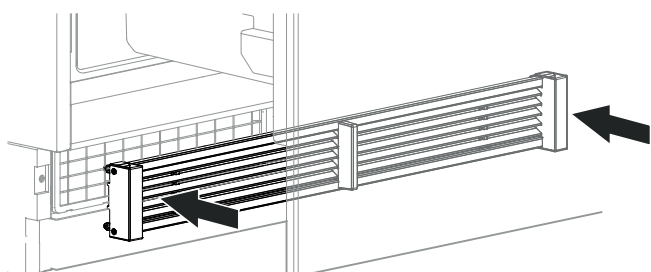

Mount the ventilation grille.

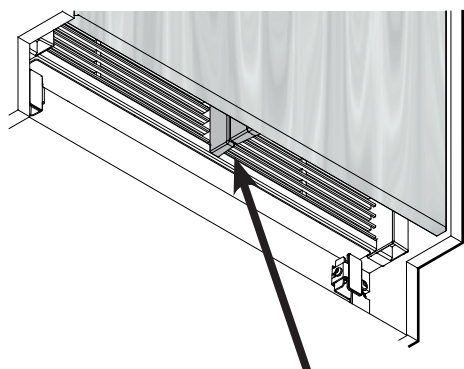

Check that there is no gap between the appliance air divider and the door air divider.

Note

There will be a gap if the ventilation grille is fitted incorrectly.

Additional functions

- BioFresh temperature adjustment
- BioFresh-Plus temperature adjustment
- Water pressure adjustment
- Heating control (ECBN 9673 / ECBN.. 99.3 only)
- Activating the defrost function manually
- Reset to factory settings
- DemoMode

Touch

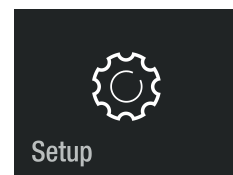

Slide to the right.

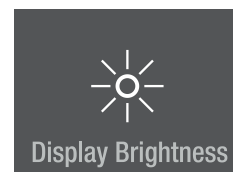

Press for approx. 2 sec.

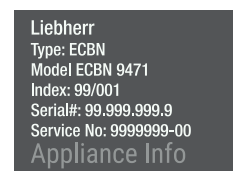

Slide to left or right.

Enter code 151.

If a wrong code is entered, the display switches back to the appliance information.

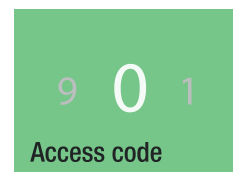

Navigate through the menu.

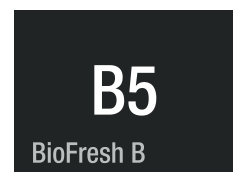

BioFresh temperature adjustment (right-hand side of the drawer)

The temperature in the drawer is kept at a constant value of around 0°C. It can be adjusted to slightly warmer or colder.



For values B4 - B1, the temperature in the drawers can drop to below 0°C. Food may freeze.

Note

Do not increase or reduce it by more than one step. Check the temperature in the BioFresh-Plus compartment during the next few days. If it is still not at the required temperature, increase or reduce the value again by one step.

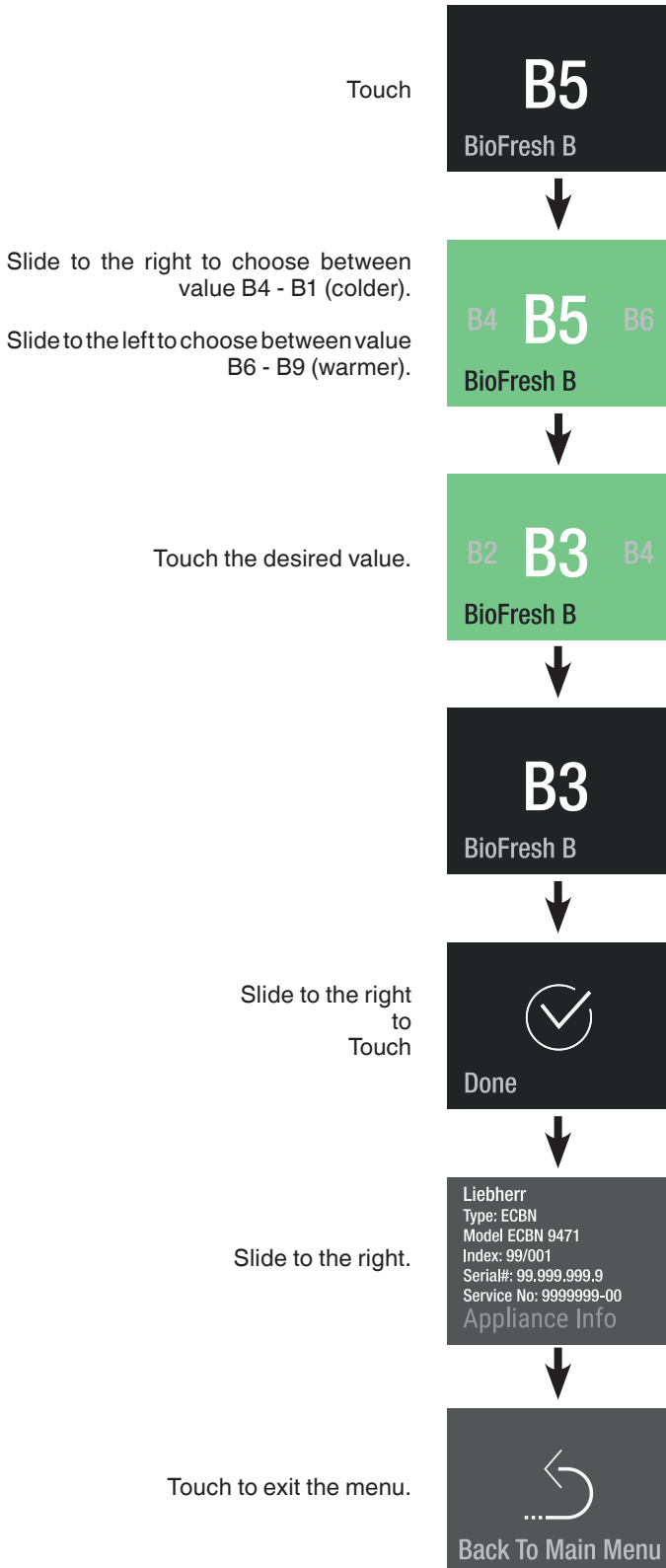

BioFresh-Plus temperature adjustment (left-hand side of the drawer)

The temperature in the drawer can be set to 0°C or -2°C. Both fixed temperature settings can be adjusted respectively to slightly warmer or colder.

Note

Do not increase or reduce it by more than one step. Check the temperature in the BioFresh-Plus compartment during the next few days. If it is still not at the required temperature, increase or reduce the value again by one step.

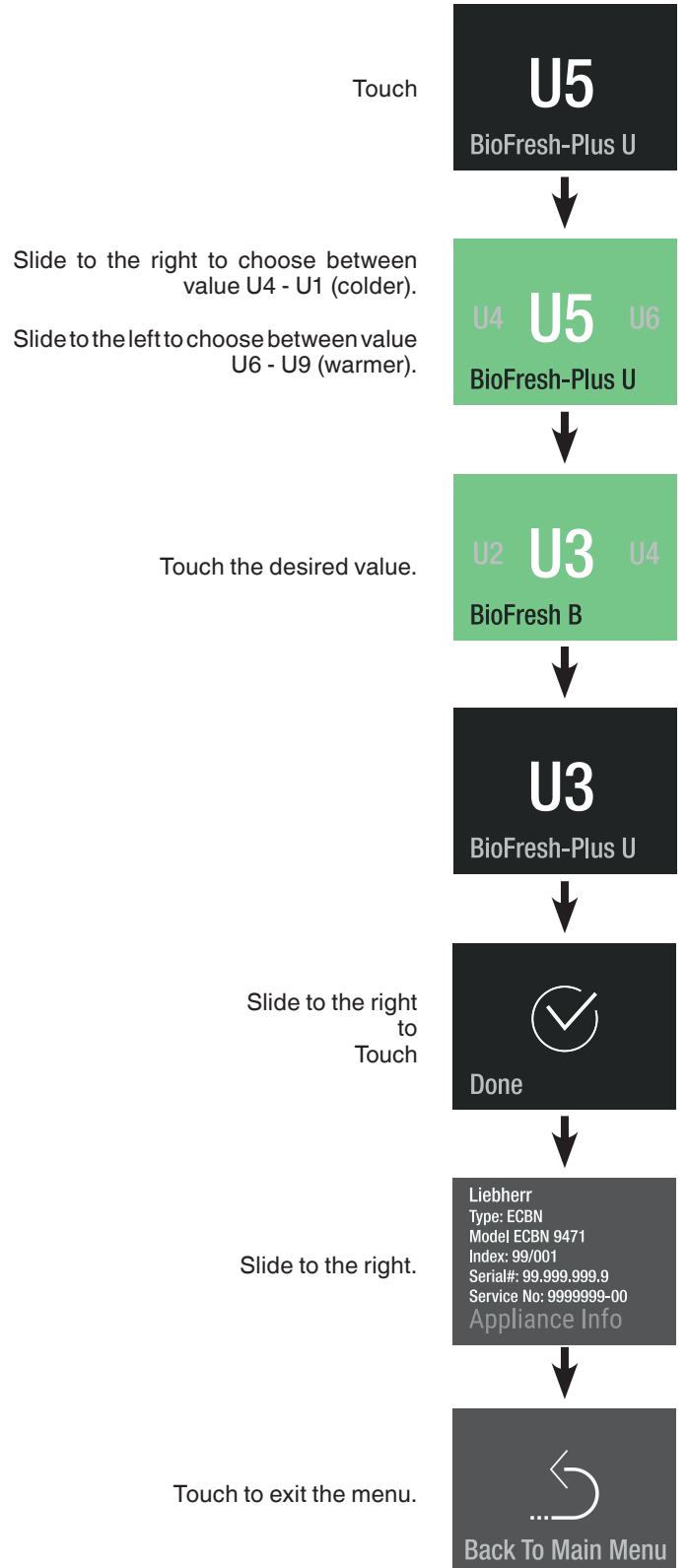

Water pressure

If the ice cubes produced by the IceMaker are too small (the first few batches are always smaller), the inflowing water quantity can be adjusted.

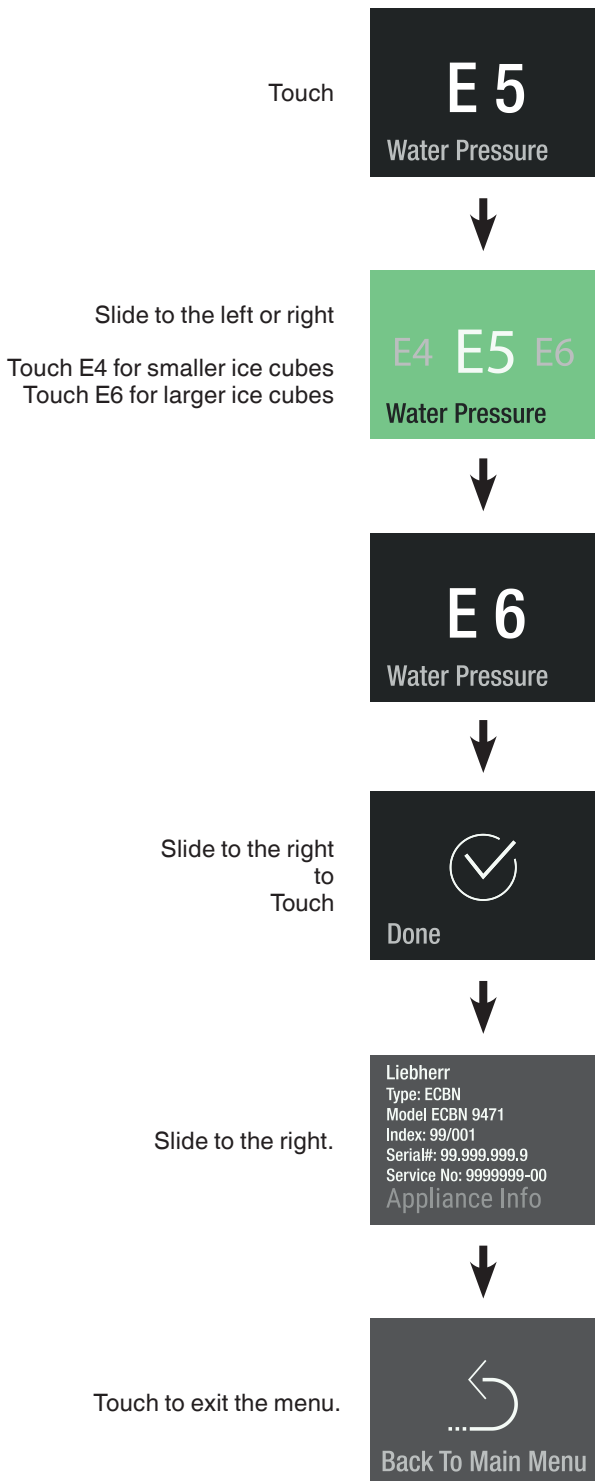

IMPORTANT

Do not increase for more than one step. If the adjusted value is too high, the ice cube tray of the ice maker could overflow.

Check the ice cube size within the next days. If the ice cubes are still smaller than desired, increase the value for one step again.

Heating control (ECBN 9673 / ECBN.. 99.3 only)

If condensation forms on the seal on the refrigerator doors, this can be rectified by activating the seal heating system.

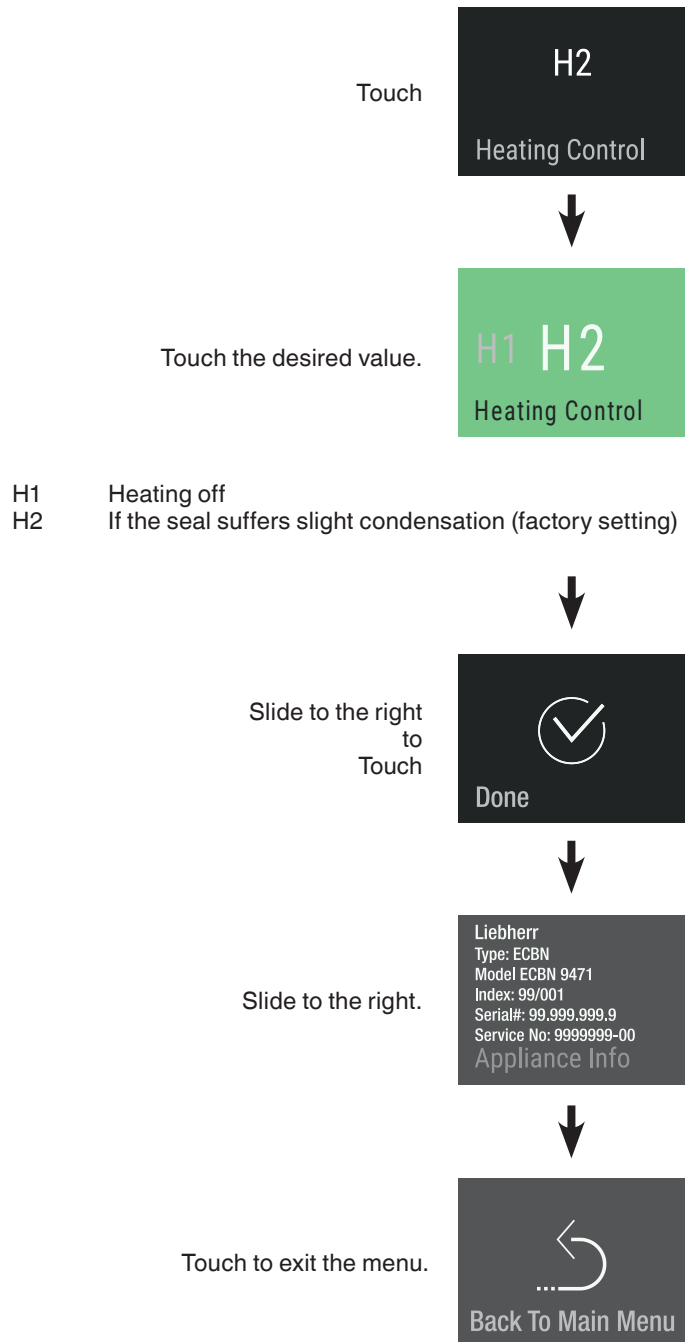

H1 Heating off
H2 If the seal suffers slight condensation (factory setting)

Manual defrost

The appliance defrosts automatically. The defrost function can be activated manually for service applications.

Freezer compartment

Refrigerator compartment

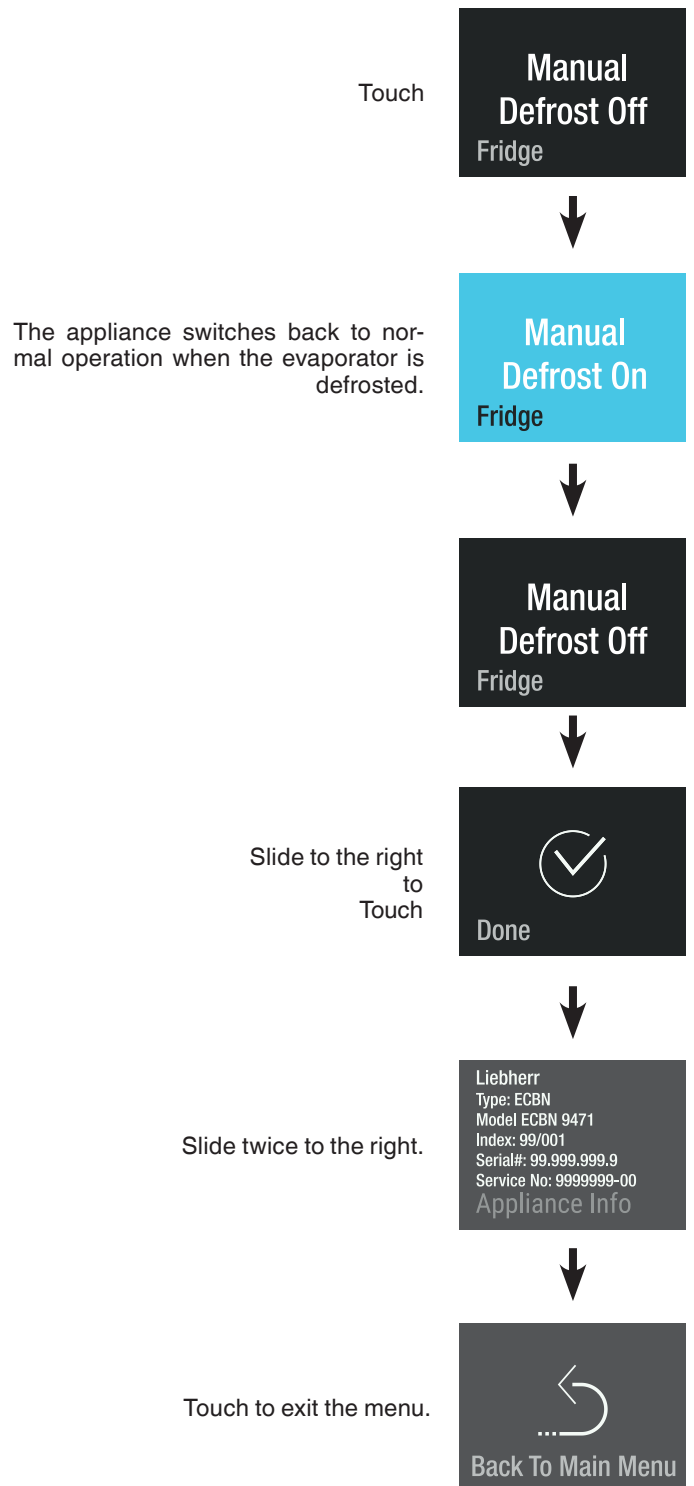
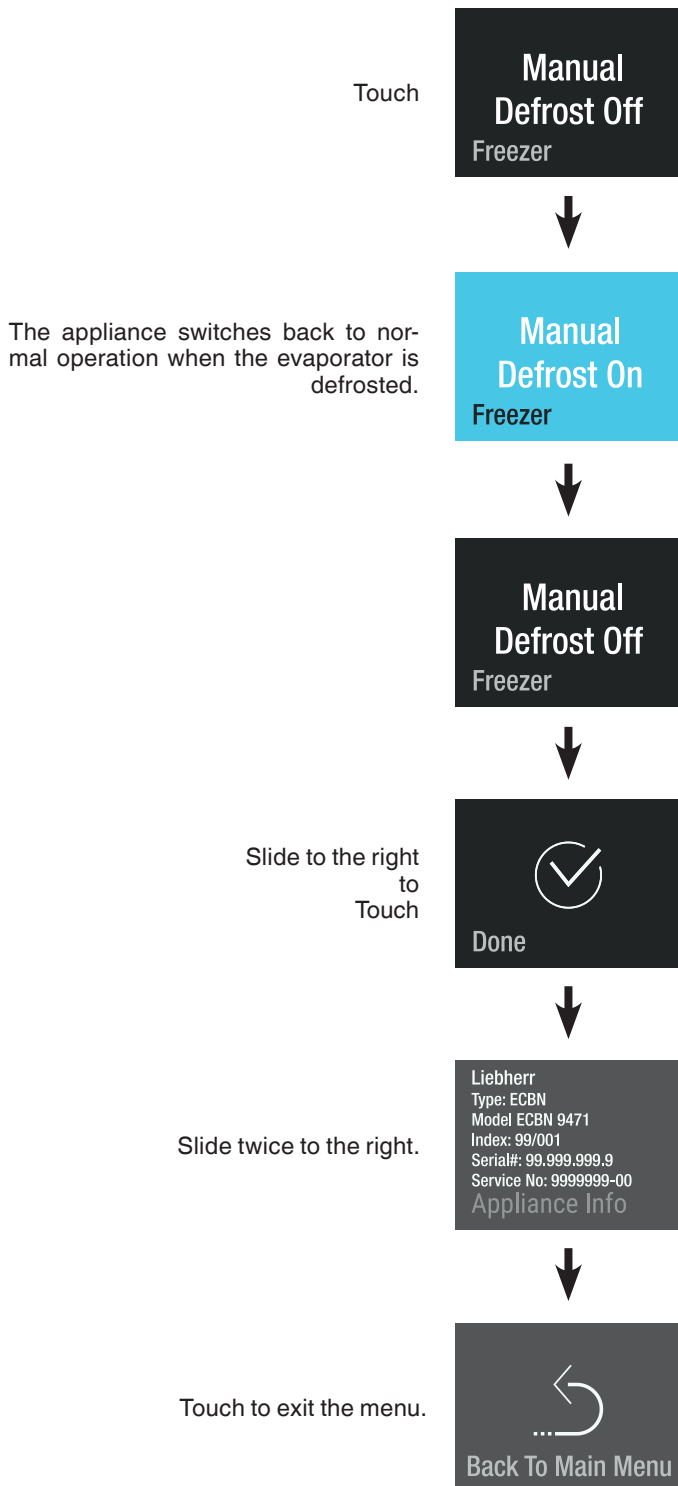

Reset

The electronic control system can be reset to factory settings using this function.

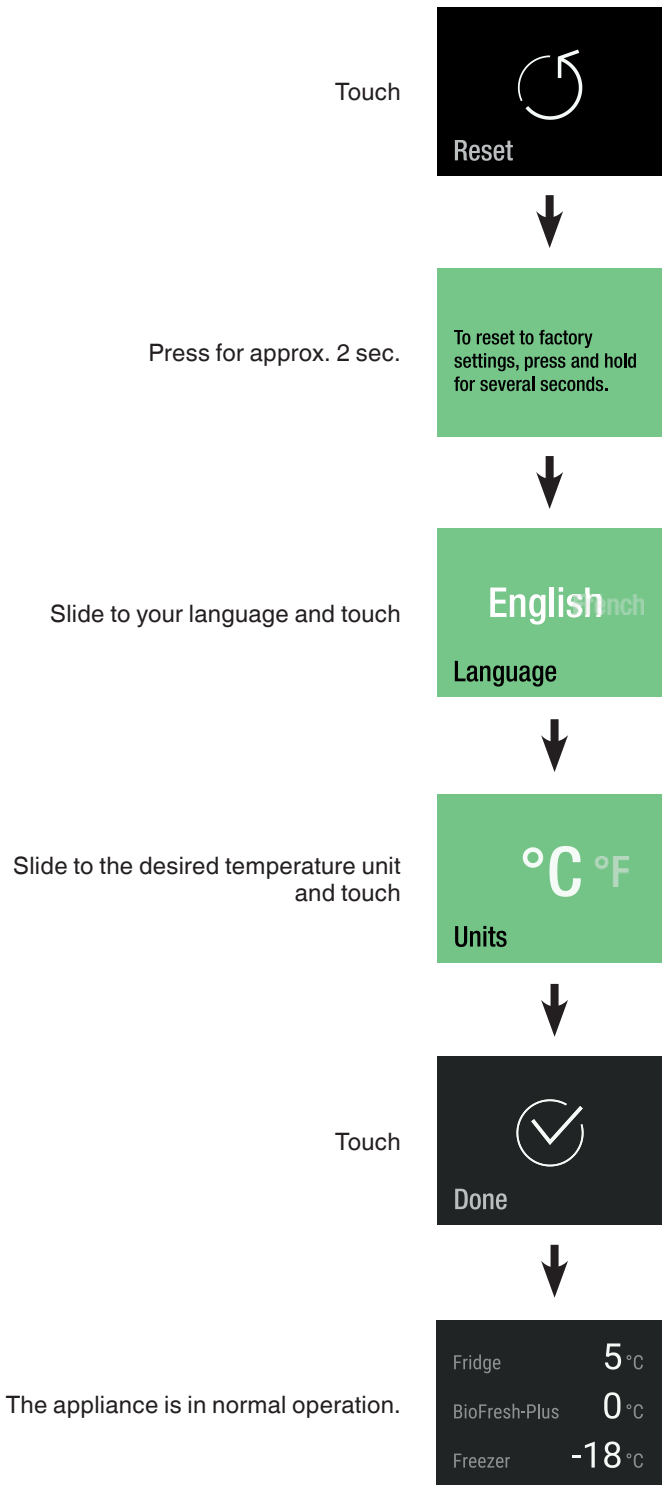

DemoMode

DemoMode can be activated for presenting the appliance at exhibitions or in salesrooms as if it were in normal operating mode.

Activating DemoMode

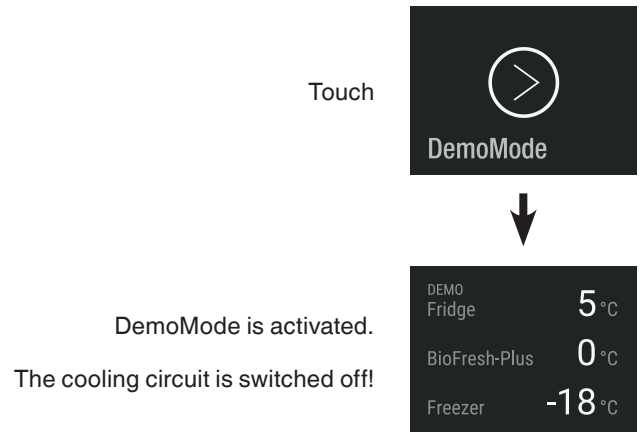

Deactivating DemoMode

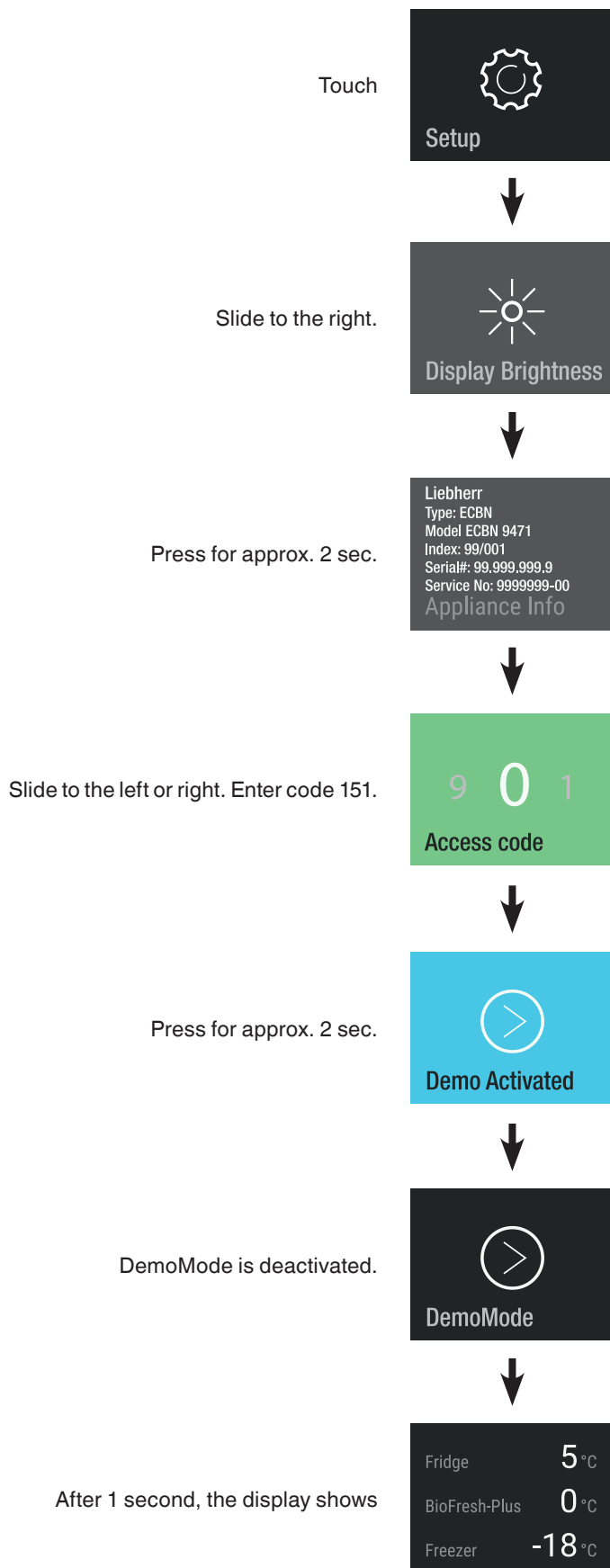

Saving energy

- Always ensure good ventilation. Do not cover ventilation openings or grille.
- Always keep fan slits clear.
- Do not place appliance in areas of direct sunlight or next to a cooker, radiator or similar object.
- The energy consumption depends on the installation conditions, e.g. the ambient temperature.
- Keep the time the appliance is open to a minimum.
- Store food logically.
- Ensure that all food is well packed and covered for storage. This will prevent frost from forming.
- First cool warm food to room temperature before storing it.
- Defrost frozen food in the refrigerator.
- Empty and switch off the refrigerator compartment for longer holiday periods.

Malfunctions

You may be able to rectify the following faults by checking the possible causes yourself:

Appliance does not function:

- Is the appliance switched on?
- Is the plug correctly fitted in the mains socket?
- Is the fuse intact?

Loud running noise:

- Is the appliance set up firmly on the floor?
- Does the appliance cause nearby items of furniture or objects to vibrate? Please note that noises caused by the refrigerant circuit cannot be avoided.

The temperature is not cold enough:

- Is the temperature setting correct (see „Setting the temperature“)?
- Have excessive amounts of fresh food been placed in the appliance?
- Does the separately installed thermometer show the correct reading?
- Is the ventilation system working properly?
- Is the appliance set up too close to a heat source?

If none of the above causes apply and you cannot rectify the fault yourself, contact the nearest customer service department stating the type designation (1), service number (2) and appliance number (3) as indicated on the type plate.

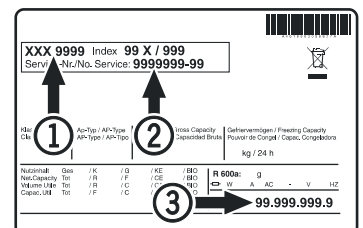

The position of the type plate is shown in the section entitled „Description of the appliance“.

Shutting your appliance down

If your appliance is to be shut down for any length of time.

Disable the IceMaker as described in "Switching the IceMaker off".

Switch it off and disconnect the plug or switch off or unscrew the fuse. Clean the appliance and leave the door open in order to prevent unpleasant smells.

The appliance complies with the relevant safety regulations and EU Directives 2014/35/EU, 2014/30/EU, 2009/125/EG and 2011/65/EU.



Liebherr Hausgeräte Lienz GmbH

Dr.-Hans-Liebherr-Strasse 1

A-9900 Lienz

Österreich

www.liebherr.com

