

EFE 3852

Impulse Sales Chest Freezer

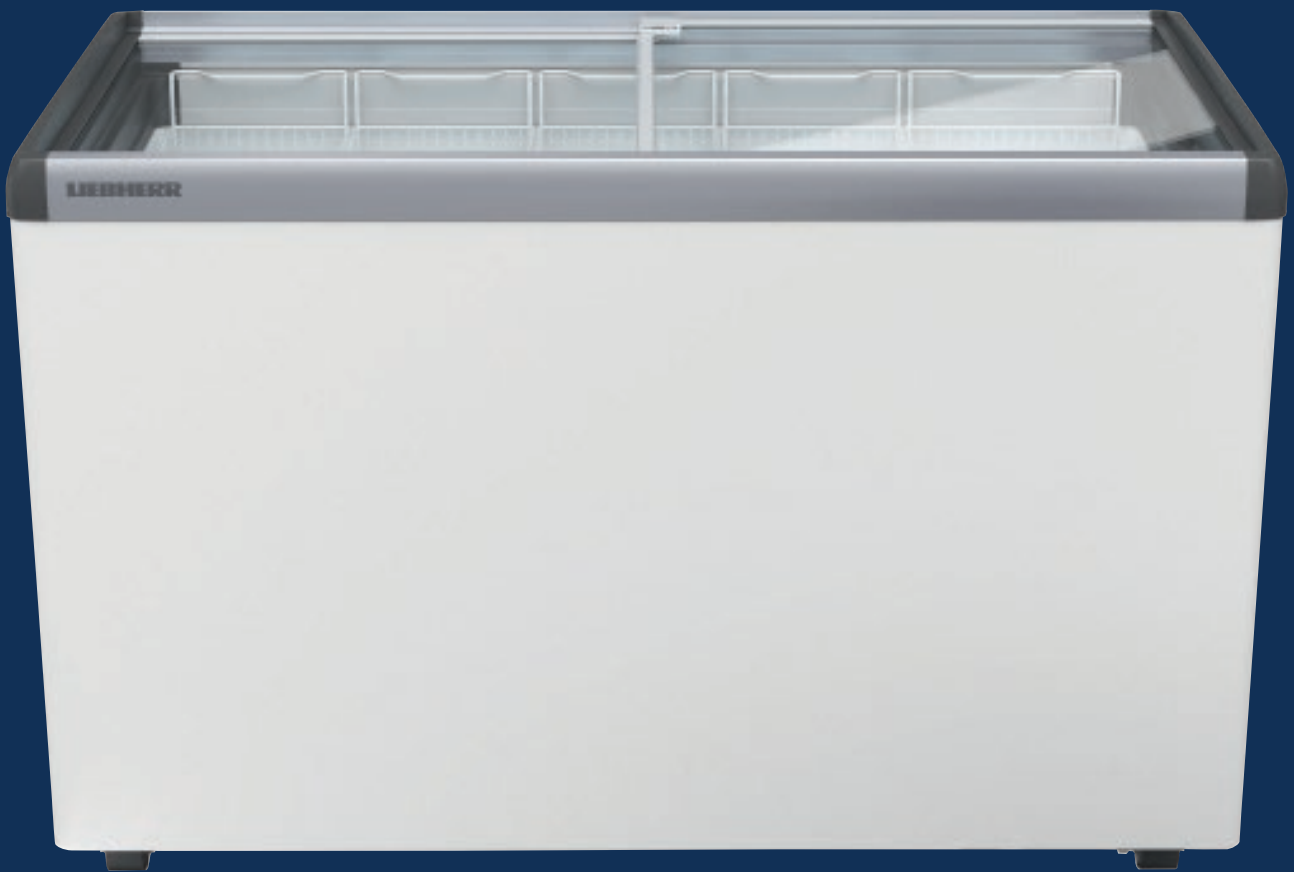

LIEBHERR

EFE 3852

Impulse Sales Chest Freezer

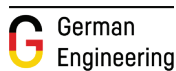

home.liebherr.com



EFE 3852	
Total gross/net capacity l (cu.ft.)	13.0 / 9.9 (369 / 280)
Exterior dimensions in inches (w/d/h) in mm (w/d/h)	49 7/16" / 26 13/16" / 32 1/2" 1255 / 680 / 825
Interior dimensions in inches (w/d/h) in mm (w/d/h)	44 1/2" / 21 1/8" / 20 5/8" 1130 / 535 / 523
Total display area in m ² (TDA)/ft ²	0.66 / 7.10
Energy Consumption in 365 days*	662 kWh
Ambient temperature in °C (°F)	50°F to 95°F (10°C to 35°C)
Refrigerant	R290
Sound rating**	52 dB(A)
Connection rating	2.5 A/224 W
Frequency/voltage	60 Hz/115 - 127V~
Cooling system/Defrost	Static/Manual
Temperature range in °C (°F)	14°F to -11°F (-10°C to -24°C)
Lid material	Sliding glass lid
External cabinet finish	Steel/White
Internal liner material	Steel
Frame color	Grey
Type of control / Temperature display	Analog control/internal analogue
Interior Light	LED
Number of baskets	5
Number of baskets, max. (see picture)	5
Castors	Swivel casters
Lock	Can be retrofitted
Insulation in inches (mm)	2 3/8" (60)
Water drain	Yes
Gross/net weight in Kg (lbs)	153.9 / 135.8 (69.8 / 61.6)

Unit Dimensions

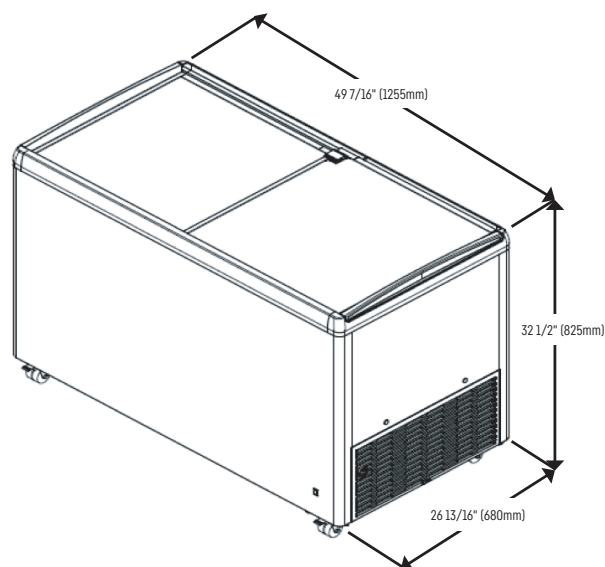

Accessories

Basket 270 mm	7111095
Basket 210 mm	7111097
Partition grid 270 mm	7111029
Partition grid 210 mm	7111784
Rubber bumpers, grey	7266707
Cylinder lock for glass sliding lid	7043660
Scoop ice cream containers	on request
Baskets for scoop ice cream containers	on request
External thermostat dial	on request

* Measured unloaded at 26.6°C (80°F) ambient temperature with set point of 3.3°C (38°F).

** Noise level - sound power re 1pW - according to IEC 60704-2-14.

LIEBHERR

Subject to modification. For up-to-date information, visit home.liebherr.com.