



User Guide

Quality, Design and Innovation























home.liebherr.com/fridge-manuals



LIEBHERR

Contents

1	General safety instructions.....	3
2	Appliance at a glance.....	4
2.1	Scope of delivery.....	4
2.2	Overview of the appliance and equipment.....	5
2.3	SmartDevice.....	5
2.4	Appliance range of use.....	5
2.5	Conformity.....	6
2.6	Spare parts.....	6
3	Functionality of the Touch & Swipe display.....	6
3.1	Navigation and symbol explanation.....	6
3.2	Menus.....	6
3.3	Sleep mode.....	7
4	Putting into operation.....	7
4.1	Switching on appliance (first use).....	7
4.2	Starting the IceMaker for the first time.....	7
5	Storage.....	8
5.1	Information regarding storage.....	8
5.2	Freezer compartment.....	8
5.3	Storage times.....	9
6	Saving energy.....	9
7	Controls.....	9
7.1	Controls and displays.....	9
7.1.1	Status display.....	9
7.1.2	Display symbols.....	9
7.2	Appliance functions.....	9
7.2.1	Notes on the appliance functions.....	9
	Switching the appliance off and on.....	9
	WiFi.....	10
	Temperature.....	11
	Temperature unit.....	11
	SuperFrost.....	11
	Start defrosting cycle.....	12
	PartyMode	12
	SabbathMode.....	13
	EnergySaver	13
	IceMaker / MaxIce	14
	IceMaker water supply.....	15
	TubeClean	15
	Display brightness.....	16
	Door alarm.....	16
	Input lock.....	16
	Language.....	17
		

	Device information.....	17
	Software.....	17
	Demo mode.....	18
	Resetting to factory settings.....	18
7.3	Messages.....	19
7.3.1	Overview of warnings.....	19
7.3.2	Ending warnings.....	19
7.3.3	Overview of reminders.....	20
7.3.4	Ending reminders.....	20
8	Features.....	20
8.1	Drawers.....	20
8.2	Pull-out board with IceTower.....	22
8.3	Glass shelves.....	23
8.4	IceMaker.....	24
8.5	VarioSpace.....	25
8.6	Freezer pack.....	25
8.7	Flexible ice compartment divider.....	25
9	Maintenance.....	25
9.1	Disassembling / assembling pull-out systems.....	25
9.2	Defrosting the appliance.....	28
9.3	Cleaning the appliance.....	28
10	Customer help.....	28
10.1	Technical specifications.....	28
10.2	Operating noises.....	29
10.3	Technical fault.....	29
10.4	Customer Service.....	31
10.5	Model plate.....	31
11	Shutting down.....	31
12	Disposal.....	31
12.1	Preparing appliance for disposal.....	31
12.2	Disposing of the appliance in an environmentally friendly manner.....	31

The manufacturer is continually working on the further development of all types and models. Please be aware that we reserve the right to make changes to the shape, equipment and technology.







Symbol	Explanation
	Read instructions Please read the information in these instructions carefully to understand all of the benefits of your new appliance.
	Additional information on the Internet The digital manual with additional information can be found via the QR code on the front of the manual or by entering the service number at home.liebherr.com/fridge-manuals . The service number can be found on the serial tag: 

Fig. Example illustration

Symbol	Explanation
	Check appliance Check all parts for transport damage. If you have any complaints, please contact your agent or customer service.
	Differences These instructions apply to a range of models, so differences are possible. Sections that apply to certain models only are marked with an asterisk (*).
	Instructions and results Instructions are marked with a ▶. Results are marked with a ▷.
	Videos Videos about the appliances are available on the YouTube channels of Liebherr-Hausgeräte.

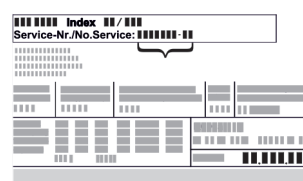
Open source licences:

The appliance contains software components that use open source licences. Information on the open source licences used can be found here: home.liebherr.com/open-source-licences

These operating instructions apply to:

SIFNh	5188
-------	------

Note

If your appliance has an N in its appliance designation, it is a NoFrost appliance.

1 General safety instructions

Please keep these instructions in a safe place and pass them on to any subsequent owners. Read these operating instructions carefully before use to ensure safe and correct use of the appliance. Follow the instructions, safety instructions and warning messages included at all times. They are important for ensuring you can operate and install the appliance safely and without any problems.

Danger for the user:

- This device can be used by children and people with impaired physical, sensory or mental abilities or with a lack of experience and knowledge provided that they are supervised or have received instruction in the safe use of this device, and about the resulting hazards. Children must not play with this appliance. Cleaning and user maintenance work must not be carried out by children without adult supervision. Children aged between 3 and 8 are allowed to load and unload the appliance. Children below the age of 3 must be kept away from the appliance unless they are under continuous adult supervision.

- The socket must be easily accessible so that the appliance can be disconnected quickly from the electricity in an emergency. It must not be located in the area behind the appliance.
- When disconnecting the appliance from the supply, always take hold of the plug. Do not pull the cable.
- In the event of a fault pull out the mains plug or deactivate the fuse.
- Do not damage the mains power cable. Do not operate the appliance with a defective mains power cable.
- If the supply cord is damaged, it must be replaced by a special cord or assembly available from the manufacturer or its service agent.
- Only customer service or other specially trained staff may repair or perform other operations on the appliance.
- Only install, connect and dispose of the appliance according to the instructions.
- Only use the appliance when is installed.
- Special lights, such as LED lights on the appliance, are used to illuminate the interior of the appliance and are not suitable for room lighting.
- The manufacturer is not liable for damage caused by a faulty fixed water connection.

Fire hazard:

- This appliance contains a refrigerant which is environmentally friendly, but flammable. Leaking refrigerant may ignite. It is hazardous for anyone other than an Authorised Service Person to service this appliance. In Queensland, the authorised Service Person MUST hold a Gas Work Authorisation for hydrocarbon refrigerants, to carry out Servicing or repairs where the gas system is being opened or charged.
- The coolant used (information on the model plate) is ecofriendly but also flammable. Any leaking coolant may ignite.
 - Do not damage the refrigerant circuit pipes.
 - Do not handle ignition sources inside the appliance.
 - Do not use electrical appliances inside the appliance (e.g. steam cleaners, heaters, ice cream makers, etc.).
 - If the refrigerant leaks: remove any naked flames or ignition sources from the vicinity of the leakage point. Properly air the room. Inform customer services.
- Do not store explosives or sprays using combustible propellants such as butane,

Appliance at a glance

propane, pentane, etc. in the appliance. To identify these spray cans, look for the list of contents printed on the can, or a flame symbol. Gases possibly escaping may ignite due to electrical components.

- Keep burning candles, lamps and other items with naked flames away from the appliance so that they do not set the appliance on fire.
- **WARNING:** Keep ventilation openings, in the appliance enclosure or in the built-in structure, clear of obstruction.
- **WARNING:** Do not use mechanical devices or other means to accelerate the defrosting process, other than those recommended by the manufacturer.
- **WARNING:** Do not damage the refrigerant circuit.
- Please be sure to store alcoholic drinks or other packaging containing alcohol in tightly closed containers. Any alcohol that leaks out may be ignited by electrical components.

Danger of tipping and falling:

- Do not misuse the plinth, drawers, doors etc. as a step or for support. This applies particularly to children.

Danger of food poisoning:

- Do not consume food which has been stored too long.

Danger of frostbite, numbness and pain:

- Avoid prolonged skin contact with cold surfaces or refrigerated/frozen goods or take protective measures, e.g wear gloves.
- Do not consume ice cream, water ice or ice cubes immediately and do not consume them too cold.

Danger of injury and damage:

- Hot steam can lead to injury. Do not use electrical heating or steam cleaning equipment, open flames or defrosting sprays to defrost.
- Do not use sharp implements to remove the ice.

Risk of crushing:

- Do not hold the hinge when opening and closing the door. Fingers may get caught.

Symbols on the appliance:



This symbol may be located on the compressor. It relates to the oil in the compressor and makes reference to the risk that: Swallowing or inhaling can be fatal. This advice is only relevant to recycling. There is no danger in normal operation.



This symbol is located on the compressor and indicates the danger of flammable materials. Do not remove the sticker.



This or a similar sticker may be located on the rear of the appliance. This sticker indicates that there are vacuum insulation panels (VIP) or perlite panels in the door and/or housing. This advice is only relevant to recycling. Do not remove the sticker.

Please note the warning messages and other specific advice in the other chapters:

	DANGER	indicates an immediately hazardous situation which will lead to death or serious injuries if it is not avoided.
	WARNING	indicates a hazardous situation which may lead to death or serious injuries if it is not avoided.
	CAUTION	indicates a hazardous situation which may lead to minor or moderate injuries if it is not avoided.
	NOTICE	indicates a hazardous situation which may lead to damage to property if it is not avoided.
	Note	indicates useful instructions and tips.

2 Appliance at a glance

2.1 Scope of delivery

Check all parts for transport damage. Contact your dealer or customer service in the event of complaints. (see 10.4 Customer Service)

Your new appliance comes with the following parts:

- Built-in appliance
- Features (depending on the model)
- Installation materials (depending on the model)
- "Quick Start Guide"
- "Installation Guide"

2.2 Overview of the appliance and equipment

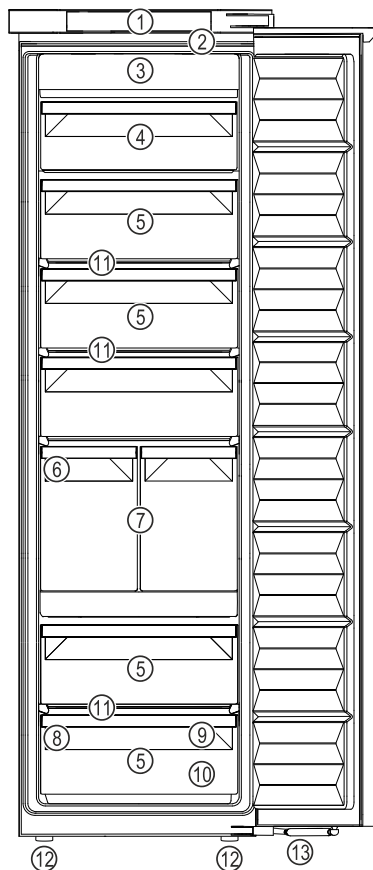

Fig. 1 Example illustration

- | | |
|--------------------|---|
| (1) Controls | (8) Type plate |
| (2) Lighting | (9) Freezer tray, cold storage accumulators |
| (3) NoFrost | (10) Ice cube scoop |
| (4) Tilting drawer | (11) VarioSpace |
| (5) Drawer | (12) Adjustable feet |
| (6) IceMaker | (13) Closing damper |
| (7) IceTower | |

Note

- Shelves, drawers and baskets are arranged for optimum energy efficiency when the appliance is delivered. Changing how the shelves, for example, are inserted in the fridge compartment does not have any impact on energy consumption.

2.3 SmartDevice

SmartDevice is the networking solution for your freezer.

If your appliance SmartDevice-enabled or compatible, you can quickly and easily connect your appliance to your WiFi. With the SmartDevice app, you can operate your appliance from a mobile device. Additional functions and setting options are available in the SmartDevice SmartDevice app.

SmartDevice-compatible appliance:

Your appliance is compatible for use with the SmartDeviceBox. You must first purchase and install the SmartDeviceBox. In order to connect your appliance to the WiFi, you need to download the SmartDevice app.



More information about SmartDevice: smartdevice.liebherr.com

Purchasing the SmartDeviceBox in the Liebherr-Hausgeräte store: home.liebherr.com/shop/de/deu/smartdevicebox.html

Downloading the SmartDevice app:



After installing and configuring the SmartDevice, you can connect your appliance to the WiFi using the SmartDevice app and the WiFi appliance function (see WiFi).

Note

The SmartDevice function is not available in the following countries: Russia, Belarus, Kazakhstan.

You cannot use the SmartDeviceBox.

2.4 Appliance range of use

Intended use

The appliance is only suitable for cooling food products in a domestic or household-like environment. This includes, for example, use:

- in staff kitchens, bed and breakfast establishments,
- by guests in country houses, hotels, motels and other accommodation,
- for catering and similar services in the wholesale trade.

All other types of use are not permitted.

Foreseeable misuse

The following applications are expressly forbidden:

- Storing and refrigerating medicines, blood plasma, laboratory preparations or similar substances and products based on the Medical Device Directive 2007/47/EC
- Use in outdoor areas with very high humidity
- Use in areas at risk of explosions

Misusing the appliance may lead to damage to the goods stored or they may spoil.

Climate classifications

Depending on the climate classification the appliance is designed to operate in restricted ambient temperatures. The climate classifica-

Functionality of the Touch & Swipe display

tion applying to your appliance is printed on the rating plate.

Note

► Keep to the specified ambient temperatures in order to guarantee that the appliance works properly.

Climate classification	for ambient temperatures of
SN	10 °C to 32 °C
N	16 °C to 32 °C
ST	16 °C to 38 °C
T	16 °C to 43 °C
SN-ST	10 °C to 38 °C
SN-T	10 °C to 43 °C

2.5 Conformity

The refrigerant circuit has been tested for leaks. When installed, the appliance complies with the applicable safety regulations and with the corresponding directives.

The full text of the EU Declaration of Conformity is available on the following website: www.Liebherr.com

2.6 Spare parts



The spare parts availability for functional parts and stockable parts of the equipment is 15 years.





3 Functionality of the Touch & Swipe display

You operate your appliance using the Touch & Swipe display. You select appliance functions in the Touch & Swipe display (hereafter referred to as display) by tapping them. If you do not perform any action on the display for 10 seconds, the display either jumps back to the higher-level menu or directly to the status display.

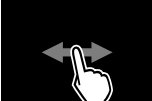
3.1 Navigation and symbol explanation

In the illustrations, different symbols are used to navigate the display. The following table describes these symbols.

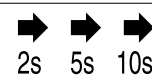
Symbol	Description
	Briefly touch the display: Activates/deactivates function. Confirms selection. Opens submenu.
	Touch the display for a specified time (e.g. 3 seconds): Activates/deactivates function or value.
	Swipe left or right: Navigate in the menu.

Symbol	Description
	Briefly touch the Back symbol: Jumps back one menu level.
	Press and hold the Back symbol for 3 seconds: Jumps back to the status display.
	Arrow with clock: It takes more than 10 seconds for the following message to appear in the display.
	Arrow with a time indication: It takes the specified amount of time until the following message appears in the display.
	“Open Settings menu” symbol: Navigates to the Settings menu and opens the settings menu. If necessary: Navigate to the desired function in the Settings menu. (see 3.2.1 Opening the Settings menu)
	“Open Advanced menu” symbol: Navigates to the Advanced menu and opens the advanced menu. If necessary: Navigate to the desired function in the Advanced menu. (see 3.2.2 Opening the expanded menu)
No action for 10 seconds	If you do not perform any action on the display for 10 seconds, the display either jumps back to the higher-level menu or directly to the status display.
Open door and close it again.	If you open the door and immediately close it again, the display jumps directly back to the status display.

Note: Illustrations of the display are shown in the English version.

3.2 Menus

The appliance functions are distributed over various menus:

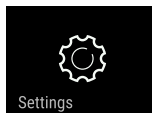
Menu	Description
Main menu	When you switch the appliance on, you are automatically in the main menu. From here you can navigate to the most important appliance functions, to the Settings menu and to the Advanced menu.
 Settings menu	The Settings menu contains additional appliance functions for setting up your appliance.

Menu	Description
Advanced menu	The advanced menu contains special appliance functions for setting up your appliance. Access to the Advanced menu is protected by the numerical code 151 .

3.2.1 Opening the Settings menu

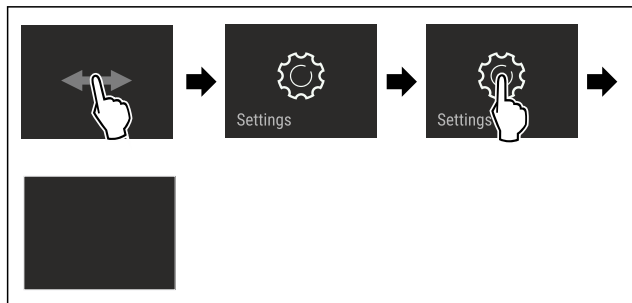

Fig. 2 Example illustration

- ▶ Carry out action steps according to the illustration.
- ▶ Settings menu is open.
- ▶ If necessary: Navigate to the desired function.

3.2.2 Opening the expanded menu



Fig. 3

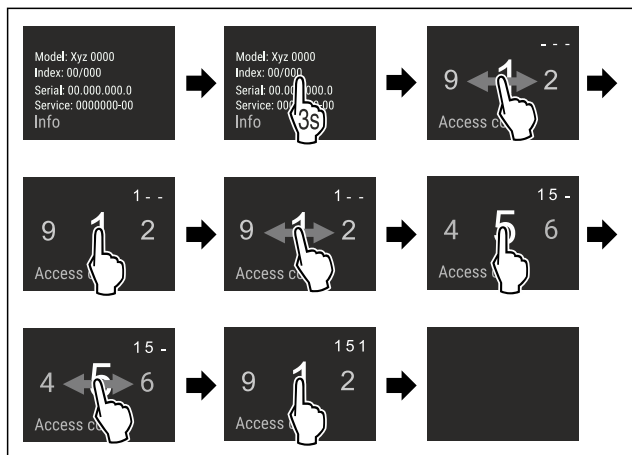

Fig. 4 Example illustration, access with numerical code **151**

- ▶ Carry out action steps according to the illustration.
- ▶ The expanded menu is open.
- ▶ If necessary: Navigate to the desired function.

3.3 Sleep mode

If you do not touch the display for 1 minute, the display switches to sleep mode. In sleep mode, the display brightness is dimmed.

3.3.1 Ending sleep mode

- ▶ Touch the display briefly with your finger.
- ▶ Sleep mode is ended.

4 Putting into operation

4.1 Switching on appliance (first use)

Make sure that the following requirements are fulfilled:

- ❑ The appliance is properly installed and connected according to the installation instructions.
- ❑ All adhesive strips, adhesive and protective films and transport locks are removed from inside and on the appliance.
- ❑ All marketing leaflets are removed from the drawers.
- ❑ You are familiar with the functionality of the Touch & Swipe display. (see 3 Functionality of the Touch & Swipe display)

Switch on the appliance using the Touch & Swipe display:

- ▶ If the display is in sleep mode: Briefly touch the display.
- ▶ Carry out action steps according to the illustration.

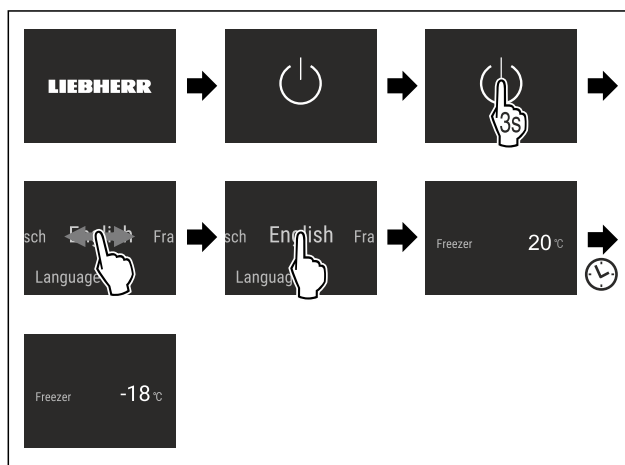

Fig. 5 Example illustration

- ▶ Status display appears.
- ▶ The appliance cools to the temperature set at the factory.
- ▶ The appliance starts in demo mode (status display with DEMO appears): If the appliance starts in demo mode, you can deactivate demo mode within the next 5 minutes. (see Demo mode)

More information:

- Start the IceMaker for the first time. (see 4.2 Starting the IceMaker for the first time)
- Start the SmartDevice for the first time. (see 2.3 Smart-Device) and (see WiFi)

Note

The manufacturer recommends:

- ▶ **Store frozen foods** at -18 °C or colder.
- ▶ Observe the notes on storing food. (see 5.1 Information regarding storage)

Note

Accessories can be purchased from the Liebherr-Hausgeräte store at home.liebherr.com/shop/de/deu/zubehor.html.

4.2 Starting the IceMaker for the first time

If your appliance is equipped with IceMaker, you must clean the IceMaker **before using it for the first time**.

Make sure that the following requirements are fulfilled:

- ❑ The water supply has been connected. See Installation Guide or mounting instructions.
- ❑ The appliance is properly installed and connected.

Storage

► Clean the IceMaker. (see 9.3.4 Cleaning the IceMaker)

5 Storage

5.1 Information regarding storage



WARNING

Fire hazard from electrical appliances!

If you use electrical appliances in the food area of your appliance, they can cause a fire.

► Do not use electrical appliances in the food area of the appliance unless recommended by the manufacturer.

Note

The energy consumption increases and the cooling power goes down if ventilation is not sufficient.

► Always keep air slots clear.

Observe the following specifications for storage:

- Package food properly.
- Package raw meat or fish in clean, closed containers. This will prevent meat or fish from touching or dripping onto other food.
- Leave space between goods to ensure good air circulation.
- Store food according to the instructions on the packaging.
- Always observe the best-before date indicated on the packaging.

Note

Failure to follow these guidelines can lead to foodstuffs spoiling.

5.2 Freezer compartment

Here, a dry, frosty storage climate is created at -18 °C. The frosty storage climate is suitable for storing frozen food for several months, for making ice cubes or freezing fresh food.

5.2.1 Freezing food

Freezing quantity

The maximum amount of fresh food that you can freeze within 24 hours is specified on the type plate (see 10.5 Model plate) under "Freezing capacity ... kg/24h".

To ensure that food quickly freezes through, adhere to the following quantities per package:

- Fruit and vegetables up to 1 kg
- Meat up to 2.5 kg

Freezing food using SuperFrost

Depending on the quantity to be frozen, you can activate SuperFrost before freezing in order to achieve lower freezing temperatures. (see SuperFrost)

► Activate SuperFrost if the amount of food you have to freeze is more than approx. 2 kg.

The time at which you activate SuperFrost depends on the amount of food you have to freeze:

Freezing quantity	Time at which you should activate SuperFrost
Small amount of food to freeze	Activate SuperFrost about 6 hours before freezing. You can place the food in the freezer as soon as the appliance automatically deactivates SuperFrost.
Maximum amount of food to freeze	Activate SuperFrost about 24 hours before freezing. You can place the food in the freezer as soon as the appliance automatically deactivates SuperFrost.

Arranging your food properly



CAUTION

Risk of injury from broken glass!

Bottles and cans with beverages can burst during freezing. This applies in particular to carbonated beverages.

► Only freeze bottles and cans with beverages if you have activated the BottleTimer function in the SmartDevice app.

Appliance height < 1220 mm	
Freezing quantity	Arranging your food properly
Small amount of food to freeze	Distribute packaged groceries throughout all drawers. If possible, place groceries at the back of the drawer near the rear wall.
Maximum amount of food to freeze	Distribute packaged groceries throughout all drawers. If possible, place groceries at the back of the drawer near the rear wall.

Appliance height ≥ 1220 mm	
Freezing quantity	Arranging your food properly
Small amount of food to freeze	Distribute packaged groceries throughout all drawers, but do not place any groceries in the top drawer.
Maximum amount of food to freeze	Distribute packaged groceries throughout all drawers. If possible, place groceries at the back of the drawer near the rear wall.

5.2.2 Defrosting food



WARNING

Risk of food poisoning!

► Do not re-freeze thawed food.

► Use defrosted foodstuff as soon as possible.

You can defrost food in several ways:

- In a fridge
 - In the microwave
 - In the oven/fan-assisted oven
 - At room temperature
- Take out only as much food as necessary.

5.2.3 Freezer tray

You can freeze berries, herbs, vegetables and other small frozen food in the freezer tray without it all freezing together. The frozen food is less likely to get squashed and subsequent portioning is easier.

In addition, you can store the cold storage accumulators in the freezer tray to save space.

- Distribute food on the freezer tray without packaging and well spaced out.

5.3 Storage times

Refer to the specified storage times as a guide.

In the case of foods with a minimum shelf life, the date indicated on the packaging still applies.

Recommended storage period for various types of food		
Ice cream	at -18 °C	2 to 6 months
Sausages, ham	at -18 °C	2 to 3 months
Bread, baked goods	at -18 °C	2 to 6 months
Game, pork	at -18 °C	6 to 9 months
Fatty fish	at -18 °C	2 to 6 months
Lean fish	at -18 °C	6 to 8 months
Cheese	at -18 °C	2 to 6 months
Poultry, beef	at -18 °C	6 to 12 months
Vegetables, fruit	at -18 °C	6 to 12 months

6 Saving energy

- Pay attention to good ventilation. Do not cover ventilation holes or grids.
- Always keep the fan air slits clear.
- Do not install the appliance in direct sunlight or near radiators or similar sources of heat.
- If the appliance is installed directly next to an oven, the energy consumption may increase slightly. This is dependent on the service life and usage intensity of the oven.
- Energy consumption depends on the installation conditions, e.g. the ambient temperature (see 2.4 Appliance range of use) . A warmer ambient temperature can increase the energy consumption.
- Open the appliance for as short a time as possible.
- The lower the temperature is set the higher the energy consumption.
- Keep all food properly packed and covered. This prevents frost from forming.
- Inserting warm food: allow to cool down to room temperature first.

7 Controls

7.1 Controls and displays

7.1.1 Status display

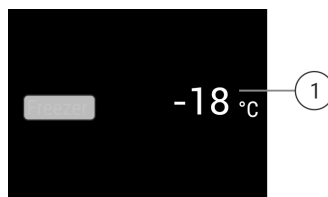

Fig. 6 The status display shows the actual temperature.

(1) Temperature display

The status display shows the actual temperature and is the initial display. Navigation to the functions takes place from there.

7.1.2 Display symbols

Display symbols provide information on the current appliance status:

Symbol	Appliance status
	Standby The appliance or temperature zone is switched off.
	Flashing number Appliance is working. Temperature flashes until the set temperature is reached.
	Flashing symbol Appliance is working. Setting is made.

7.2 Appliance functions

7.2.1 Notes on the appliance functions

The appliance functions are set at the factory so that your appliance is fully functional.

Before you alter, activate or deactivate the device functions, make sure that the following requirements are met:

- You have read and understood the descriptions of how the display works. (see 3 Functionality of the Touch & Swipe display)
- You have familiarised yourself with the operating and display elements of your appliance.



Switching the appliance off and on

Use this function to switch the entire appliance off and on.

Switching off the appliance

When you switch the appliance off, then the previously saved settings are saved.

Make sure that the following requirements are fulfilled:

- Handling instructions (see 11 Shutting down) are carried out.



Fig. 7

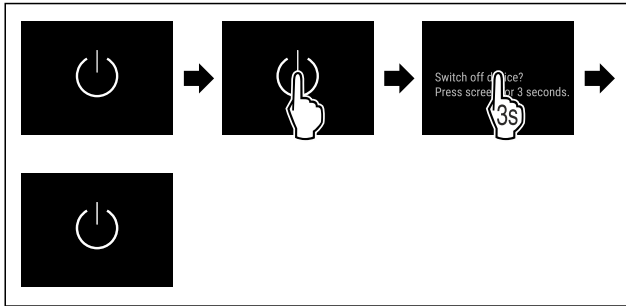

Fig. 8

- ▶ Carry out action steps according to the illustration.
- ▶ Appliance is switched off.
- ▶ The standby symbol appears in the display.
- ▶ Display turns black.

Switching on the appliance

If the display is in sleep mode:

- ▶ Briefly touch the display.

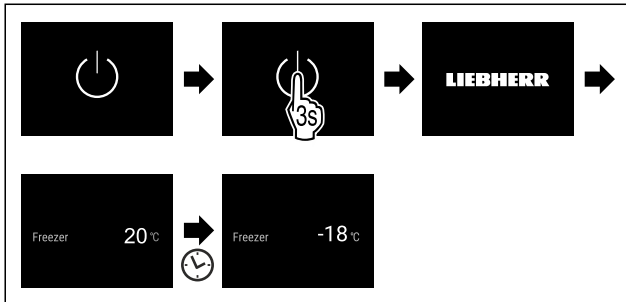

Fig. 9 Example illustration

- ▶ Carry out action steps according to the illustration.
- ▶ When the appliance starts in demo mode:
- ▶ Deactivating demo mode. (see Deactivating demo mode)
- ▶ The appliance is switched on.
- ▶ Previous settings are restored.
- ▶ The appliance cools to the target temperature set.



Use this function to connect your appliance to WiFi. You can then operate it via the SmartDevice app on a mobile device. You can also use this function to disconnect or reset the WiFi connection.

To connect your device to WiFi, you need the SmartDeviceBox.

More information on the SmartDevice: (see 2.3 SmartDevice)

Note

The SmartDevice function is not available in the following countries: Russia, Belarus, Kazakhstan.

You cannot use the SmartDeviceBox.

Establishing the WiFi connection for the first time

Make sure that the following requirements are fulfilled:

- You have purchased and inserted a SmartDeviceBox. (see 2.3 SmartDevice)
- You have installed the SmartDevice app (see apps.home.liebherr.com).
- Registration in the SmartDevice app is completed.



Fig. 10

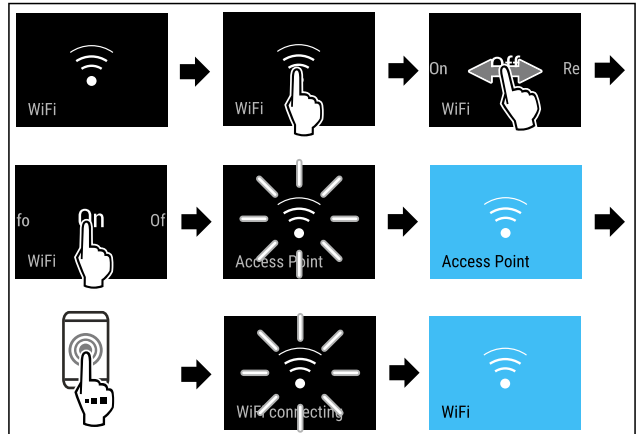

Fig. 11

- ▶ Carry out action steps according to the illustration.
- ▶ Connection is established.

Disconnecting from the WiFi

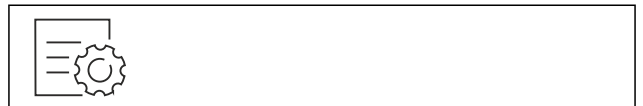

Fig. 12

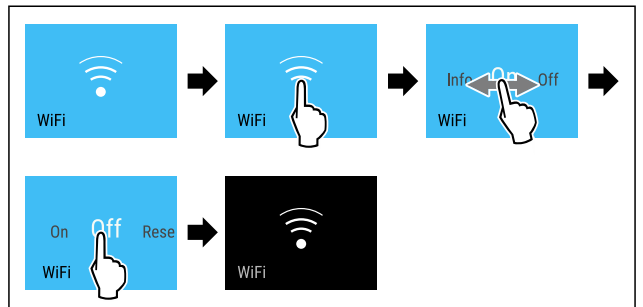

Fig. 13

- ▶ Carry out action steps according to the illustration.
- ▶ There is no connection.

Resetting the WiFi connection



Fig. 14

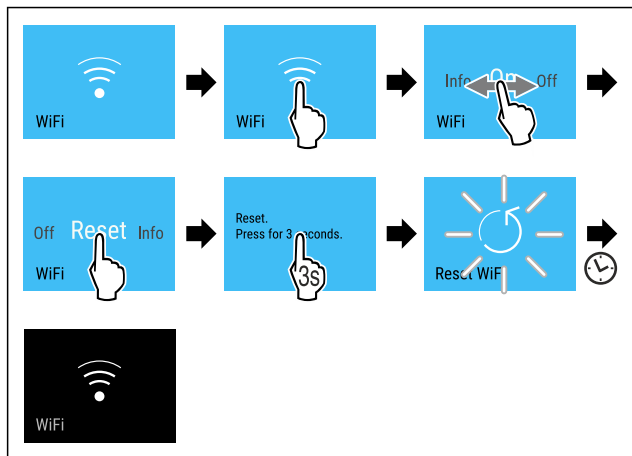

Fig. 15

- ▶ Carry out action steps according to the illustration.
- ▶ WiFi connection and other WiFi settings are reset to factory settings.

Showing information about the WiFi connection

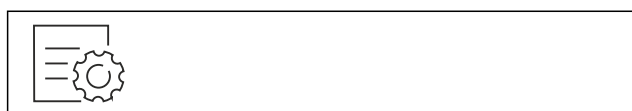

Fig. 16

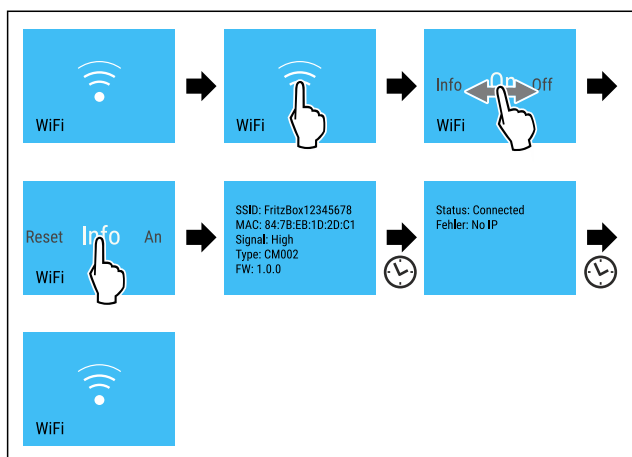

Fig. 17

- ▶ Carry out action steps according to the illustration.

-18°C Temperature

Use this function to set the temperature.

The temperature depends on the following factors:

- Frequency of door opening
- Duration of door opening
- Room temperature of the installation site
- Type, temperature and quantity of food

Freezer compartment	Factory-set temperature	Recommended setting
-18°C	-18 °C	-18 °C

Setting the temperature

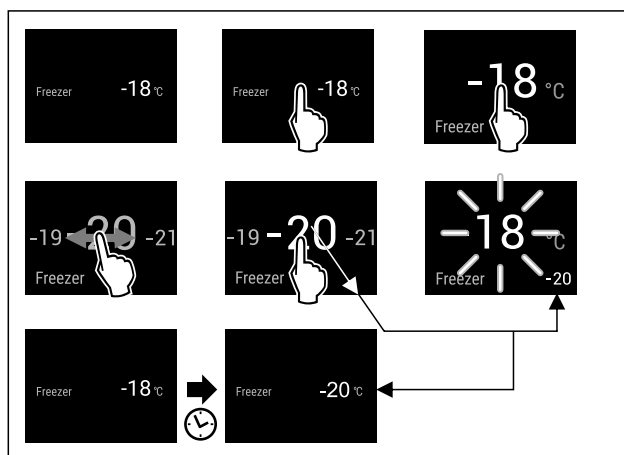

Fig. 18 Example illustration

- ▶ Carry out action steps according to the illustration.
- ▶ Temperature is set.

°C/°F Temperature unit

Use this function to set the temperature unit. You can set degrees Celsius or degrees Fahrenheit as the temperature unit.

Setting the temperature unit



Fig. 19

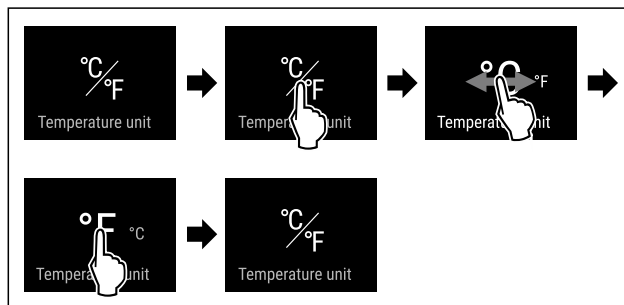

Fig. 21 Example illustration: Switch from degrees Celsius to degrees Fahrenheit.

- ▶ Carry out action steps according to the illustration.
- ▶ The temperature unit is set.

*** * *** SuperFrost

You can use this function to activate or deactivate SuperFrost. If SuperFrost is activated, then the appliance increases the freezing capacity. It allows you to achieve lower freezing temperatures.

Application:

- Quickly freeze fresh food through to the core. This ensures that the nutrition, appearance and taste of frozen food is maintained.
- Increase the cold reserve in stored frozen food before defrosting the appliance.

If the function is active, the appliance operates at higher power. As a result, the appliance's operating noise may be temporarily louder and energy consumption will increase.

Controls

Activating SuperFrost

Make sure that the following requirements are fulfilled:

- ❑ Freezing quantity and time for activation of SuperFrost are taken into account. (see Freezing food using SuperFrost)



Fig. 22

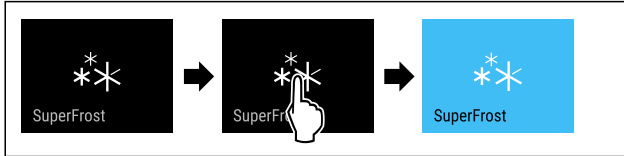

Fig. 23

- ▶ Carry out action steps according to the illustration.
- ▶ SuperFrost is activated.
- ▶ The temperature display turns blue.

Deactivating SuperFrost

SuperFrost is automatically deactivated after 56 to 72 hours depending on the quantity of the food inserted. However, you can also deactivate SuperFrost manually at any time:



Fig. 24



Fig. 25

- ▶ Carry out action steps according to the illustration.
- ▶ SuperFrost is deactivated.
- ▶ The appliance continues to run in normal mode.
- ▶ The appliance cools to the temperature set previously.



Start defrosting cycle

Use this function to start the automatic defrosting cycle manually if it does not start automatically in the event of a fault.

Starting defrosting cycle



Fig. 26

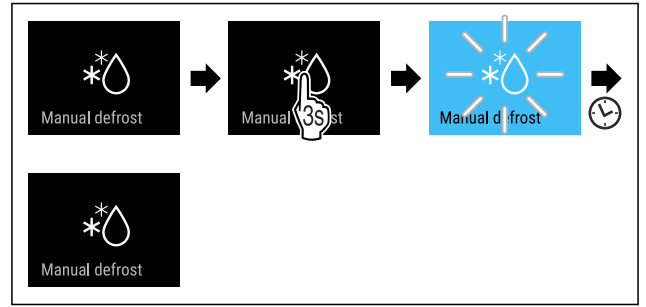

Fig. 27

- ▶ Carry out action steps according to the illustration.
- ▶ Defrosting cycle has started: Icon flashes until defrosting cycle is automatically completed.
- ▶ When defrosting cycle is finished: The device continues to run in normal mode.

Cancelling defrosting cycle

The defrosting cycle will be stopped automatically. However, you can also cancel the defrosting cycle at any time during the defrosting process:

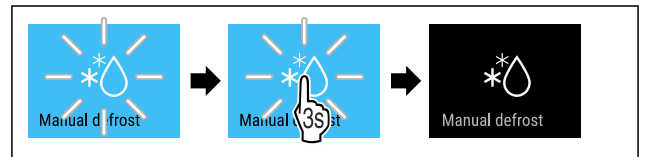

Fig. 28

- ▶ Carry out action steps according to the illustration.
- ▶ Defrosting cycle is cancelled.
- ▶ The device continues to run in normal mode.



PartyMode

You can use this function to activate or deactivate PartyMode. PartyMode activates various functions that are useful for a party.

PartyMode activates the following functions:

- SuperFrost (see SuperFrost)
- IceMaker with MaxIce (see IceMaker / MaxIce)

You can adjust all listed functions individually and flexibly. When you deactivate PartyMode, all changes are discarded.

If the function is active, the device operates at higher power. As a result, the device's operating noise may be temporarily louder and energy consumption will increase.

Activating PartyMode

Make sure that the following requirements are fulfilled:

- ❑ The IceMaker has been started. (see 4.2 Starting the IceMaker for the first time)

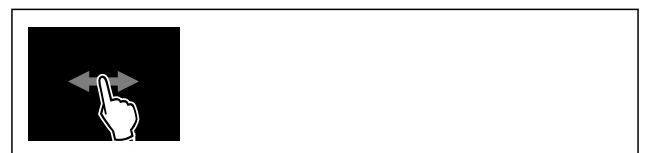

Fig. 29

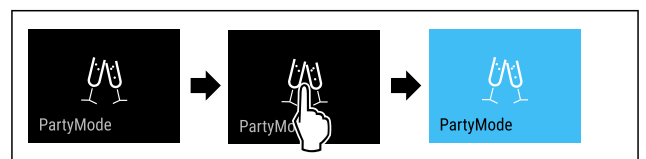

Fig. 30

- ▶ Carry out action steps according to the illustration.
- ▶ PartyMode and the associated functions are activated.

- ▶ The temperature display turns blue.
- ▶ The current temperature flashes until the target temperature is reached.

Deactivating PartyMode

The PartyMode is automatically deactivated after 24 seconds. However, you can also deactivate PartyMode manually at any time:



Fig. 31

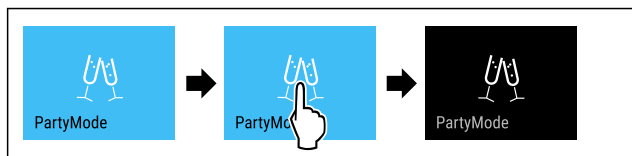

Fig. 32

- ▶ Carry out action steps according to the illustration.
- ▶ PartyMode is deactivated.
- ▶ The appliance cools to the temperature set previously: The current temperature flashes until the target temperature is reached.

SabbathMode

You can use this function to activate or deactivate SabbathMode. If you activate this function, some electronic functions are switched off. As a result, your device meets the religious requirements for Jewish holidays such as Sabbath and complies with STAR-K Kosher certification.

Device status when SabbathMode is active
The status display shows SabbathMode permanently.
All functions on the display are locked except for the Deactivate SabbathMode function.
Active functions remain active.
The display remains bright when you close the door.
The interior lighting is deactivated.
Reminders are not implemented. The set time interval stops.
Reminders and warnings are not displayed.
There is no door alarm.
There is no temperature alarm.
The IceMaker is switched off.
The defrosting cycle operates only for the specified time, without considering the appliance consumption.
After a power failure, the appliance returns to SabbathMode.

Device status

Note

This appliance has certification from the "Institute for Science and Halacha". (www.machonhalacha.co.il)

You can find a list of STAR-K-certified appliances at www.star-k.org/appliances.

Activating SabbathMode



WARNING

Danger of food poisoning from spoiled food!

If you have SabbathMode activated and a power failure occurs, no message appears in the status display about the power failure. Once the power is restored, the appliance continues to operate in SabbathMode. The power failure may mean that food spoils and the consumption of this food could lead to food poisoning.

After a power failure:

- ▶ Do not consume food that was frozen and has thawed out.



Fig. 33

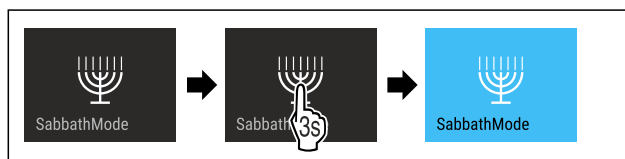

Fig. 34

- ▶ Carry out action steps according to the illustration.
- ▶ SabbathMode is activated.
- ▶ The status display shows SabbathMode permanently.

Deactivating SabbathMode

The SabbathMode is automatically deactivated after 80 hours. However, you can also deactivate SabbathMode manually at any time:



Fig. 35

- ▶ Carry out action steps according to the illustration.
- ▶ SabbathMode is deactivated.



EnergySaver

You can use this function to activate or deactivate Energy saving mode. If energy saving mode is activated, the energy consumption decreases and the temperature in the device increases. The food remains fresh, but the shelf life is shortened.

Temperature zone	Recommended setting (see Setting the temperature)	Temperature with active EnergySaver
-18 °C	-18 °C	-16 °C

Temperatures

Activating EnergySaver



Fig. 36

Controls

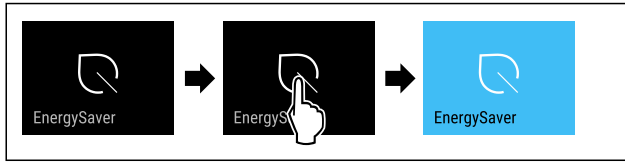

Fig. 37

- ▶ Carry out action steps according to the illustration.
- ▷ Energy saving mode is activated.

Deactivating EnergySaver



Fig. 38

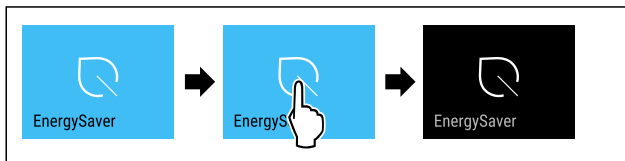

Fig. 39

- ▶ Carry out action steps according to the illustration.
- ▷ Energy saving mode is deactivated.



IceMaker / MaxIce

Use the IceMaker function to activate or deactivate the production of ice cubes. Use the MaxIce function to increase the amount of ice cubes produced by the IceMaker. MaxIce is automatically deactivated after 48 hours. However, you can also deactivate MaxIce manually at any time: (see Deactivating MaxIce)

More information on the number of ice cubes:	(see 10.1 Technical specifications)
Further information on the IceMaker water supply:	(see IceMaker water supply)
More information on cleaning the lines of the IceMaker:	(see TubeClean)

If the function is active, the device operates at higher power. As a result, the device's operating noise may be temporarily louder and energy consumption will increase.

Activating IceMaker

Make sure that the following requirements are fulfilled:

- The water supply is established at the fixed water connection. See installation instructions.
- IceMaker is put into operation. (see 8.4 IceMaker)



Fig. 40

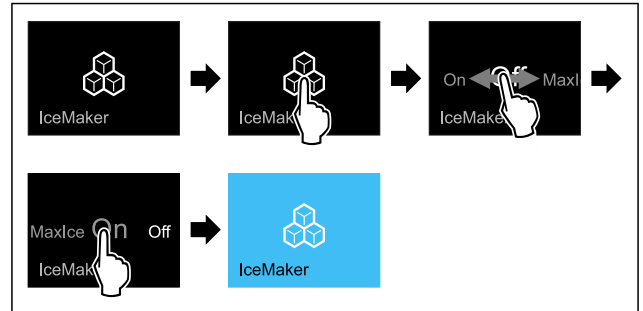

Fig. 41

- ▶ Carry out action steps according to the illustration.

-or-

- ▶ Activate with the SmartDevice app.

- ▷ IceMaker is activated. It can take up to 24 hours for the IceMaker to produce the first ice cubes.

Activating the IceMaker with MaxIce

If you have not activated the IceMaker function before, make sure that the following requirements are met:

- The water supply is established at the fixed water connection. See installation instructions.
- IceMaker is put into operation. (see 8.4 IceMaker)



Fig. 42

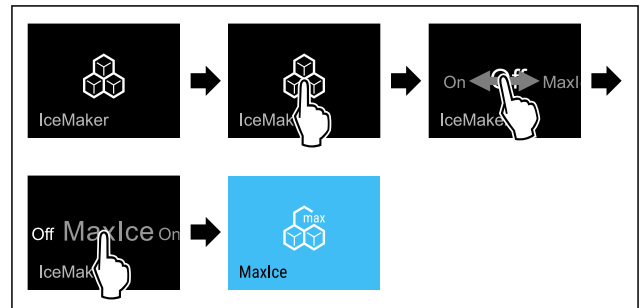

Fig. 43

- ▶ Carry out action steps according to the illustration.

-or-

- ▶ Activate with the SmartDevice app.

- ▷ The IceMaker is activated with MaxIce.

Changing between the IceMaker and MaxIce

If you have activated the IceMaker and would like to change to MaxIce:



Fig. 44

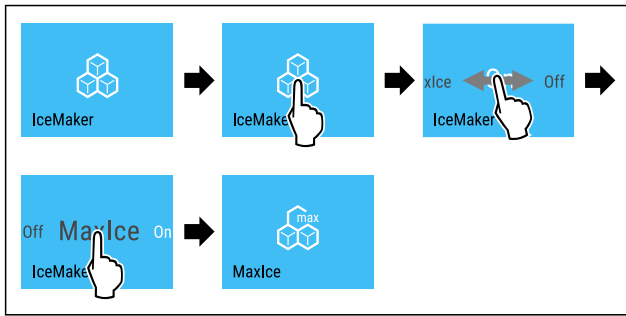

Fig. 45

- ▶ Carry out action steps according to the illustration.
- ▶ The IceMaker is activated with MaxIce.

If you have activated MaxIce and would like to change to the IceMaker:



Fig. 46

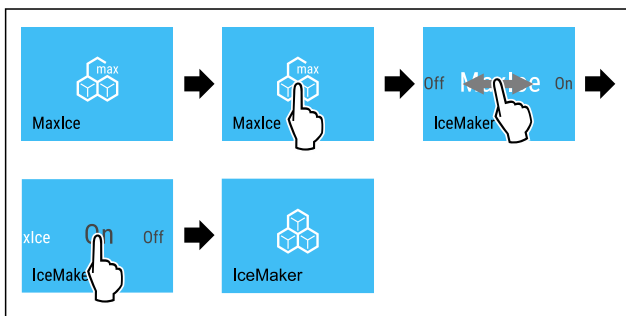

Fig. 47

- ▶ Carry out action steps according to the illustration.
- ▶ IceMaker is activated.
- ▶ MaxIce is deactivated.

Deactivating the IceMaker and MaxIce



Fig. 48

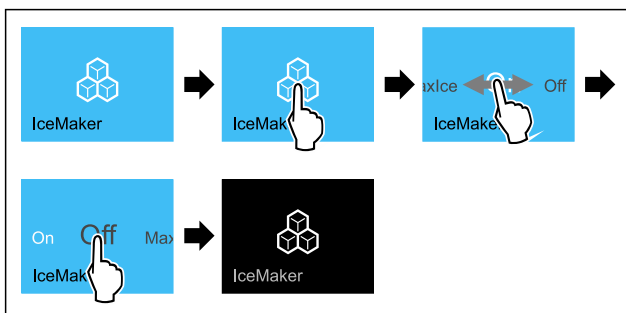

Fig. 49 Example illustration of the active IceMaker function

- ▶ Carry out action steps according to the illustration.
- or-
- ▶ Deactivate with the SmartDevice app.
- ▶ IceMaker and MaxIce are deactivated.
- ▶ If ice cubes are currently being made, the system completes the process.
- ▶ The IceMaker goes off automatically.

Deactivating MaxIce

- ▶ Activate the IceMaker. (see Activating IceMaker)
- ▶ MaxIce is deactivated.
- ▶ IceMaker is activated.
- ▶ To deactivate the IceMaker and MaxIce: (see Deactivating the IceMaker and MaxIce)

5 IceMaker water supply

Use this function to set the water supply. The water supply regulates the amount of water supplied. The water supply can be changed if it does not match the water pressure and the ice cube size dispensed.

The water supply is pre-set to value 4 as delivered. A value from 1 (smallest inflow volume) to 8 (largest inflow volume) can be selected.

Setting water supply

Make sure that the following requirements are fulfilled:

- The IceMaker has been started. (see 4.2 Starting the IceMaker for the first time)
- IceMaker is activated. (see IceMaker / MaxIce)



Fig. 50

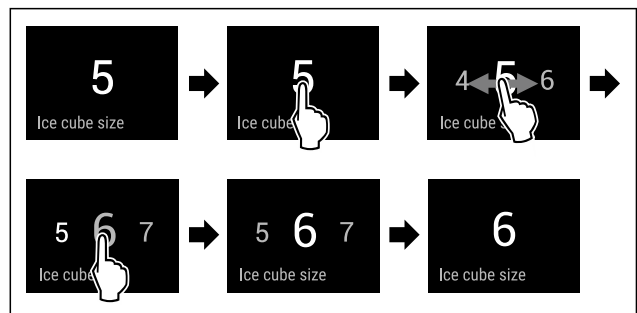

Fig. 51 Example illustration: Switch from value 5 to value 6.

- ▶ Carry out action steps according to the illustration.
- ▶ The water supply is set.



TubeClean

You can use this function to activate or deactivate TubeClean. If TubeClean is activated, it cleans the IceMaker lines.

Activating TubeClean

Make sure that the following requirements are fulfilled:

- IceMaker cleaning is prepared. (see 9.3.4 Cleaning the IceMaker)
- Empty container with a capacity of 1.5 l and with a maximum height of 10 cm is ready.
- ▶ Place the container in the drawer under the IceMaker.



Fig. 52

Controls

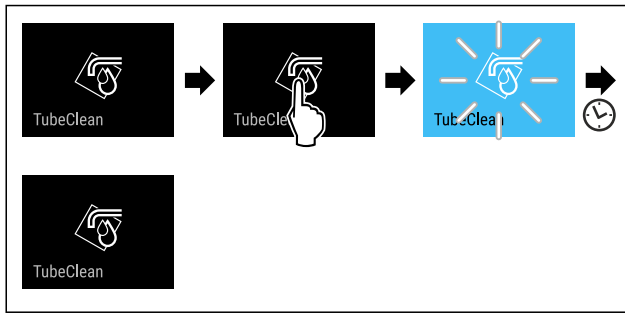

Fig. 53

- ▶ Carry out action steps according to the illustration.
- ▶ TubeClean is activated.
- ▶ The cleaning process has started: Icon flashes until the cleaning process is automatically completed after 60 minutes.
- ▶ When the cleaning process is complete: The device continues to run in normal mode.

Deactivating TubeClean

TubeClean is automatically ended after 60 minutes. However, TubeClean can also be deactivated at any time during the cleaning process:

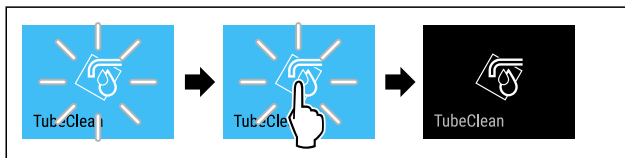

Fig. 54

- ▶ Carry out action steps according to the illustration.
- ▶ TubeClean is deactivated: Cleaning process is aborted.
- ▶ The device continues to run in normal mode.

Display brightness

Use this function to set the display brightness in stages.

You can select the following brightness levels:

- 40 %
- 60 %
- 80 %
- 100 % (pre-setting)

Setting the brightness

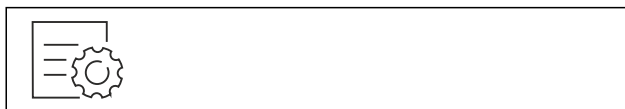

Fig. 55

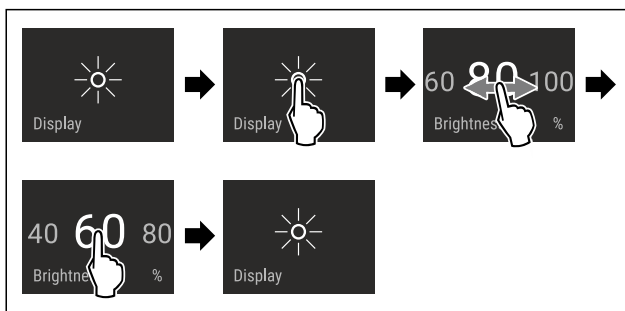

Fig. 56 Example illustration: Switch from 80 % to 60 %.

- ▶ Carry out action steps according to the illustration.
- ▶ The brightness is set.

Door alarm

Use this function to activate or deactivate the door alarm. The door alarm sounds if the door is open for too long. The door alarm is activated on delivery. You can set how long the door may be open before the door alarm sounds.

The following values can be set:

- 1 minute
- 2 minutes
- 3 minutes
- Off

Setting the door alarm



Fig. 57

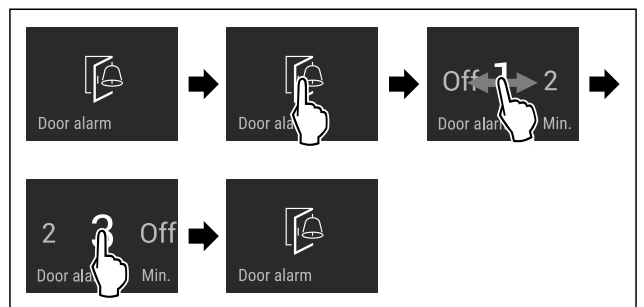

Fig. 58 Example illustration: Change door alarm from 1 minute to 3 minutes.

- ▶ Carry out action steps according to the illustration.
- ▶ The door alarm is set.

Deactivating the door alarm

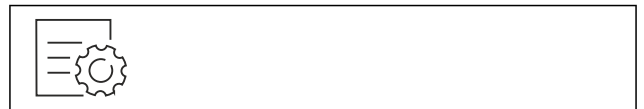

Fig. 60

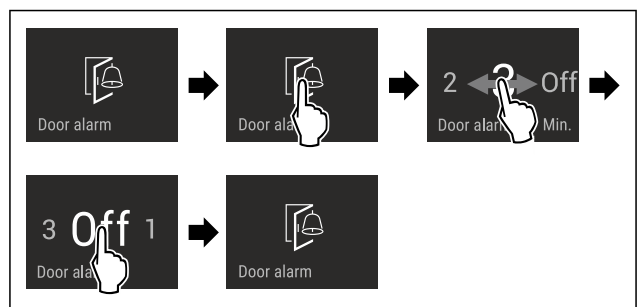

Fig. 61

- ▶ Carry out action steps according to the illustration.
- ▶ The door alarm is deactivated.

Input lock

You can use this function to activate or deactivate the input lock. The input lock prevents the appliance being operated accidentally, e.g. by children.

Application:

- Avoid unintentional modification of functions.
- Avoid unintentional switching off of the device.
- Avoid unintentional temperature setting.

Activating the input lock

If you activate the input lock, you can continue to navigate in the menus but you cannot select or change other functions.



Fig. 62

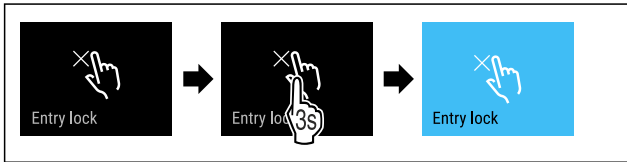

Fig. 63

- ▶ Carry out action steps according to the illustration.
- ▶ Input lock is activated.

Deactivating the input lock

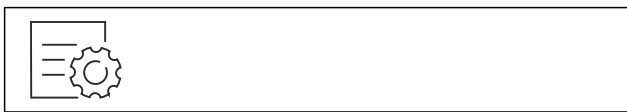

Fig. 64

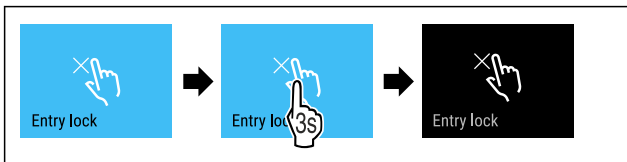

Fig. 65

- ▶ Carry out action steps according to the illustration.
- ▶ Input lock is deactivated.

Language

Use this function to set the display language.

You can select the following languages:

- Deutsch
- English
- Français
- Español
- Italiano
- Nederlands
- Čeština
- Polski
- Português
- Bulgarian
- Русский
- 温度单位

Setting the language

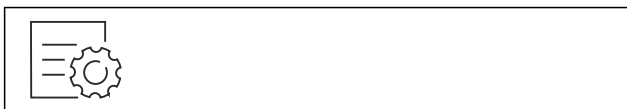

Fig. 66

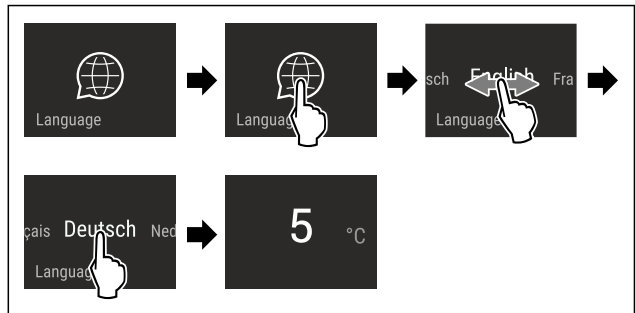

Fig. 67 Example illustration depending on the language and temperature

- ▶ Carry out action steps according to the illustration.
- ▶ The language is set.
- ▶ The display returns to the status display.



Device information

Use this function to indicate the model name, index, serial number and service number of your device. You will need the device information when you contact customer service. (see 10.4 Customer Service)

This function also opens the Advanced menu. (see 3 Functionality of the Touch & Swipe display)

Indicating the device information



Fig. 68



Fig. 69

- ▶ Carry out action steps according to the illustration.
- ▶ Display indicates device information.



Software

Use this function to indicate the software version of your device.

Indicating the software version



Fig. 70



Fig. 71

- ▶ Carry out action steps according to the illustration.
- ▶ Display indicates software version.

Demo mode

Demo mode is a special feature for dealers who want to demonstrate appliance features. If you activate demo mode, all refrigeration functions are deactivated.

If you switch on your appliance and “Demo” appears in the status display, then demo mode is already activated.

If you activate and then deactivate demo mode, the appliance will be reset to factory defaults. (see Resetting to factory settings)

Activating demo mode



Fig. 72

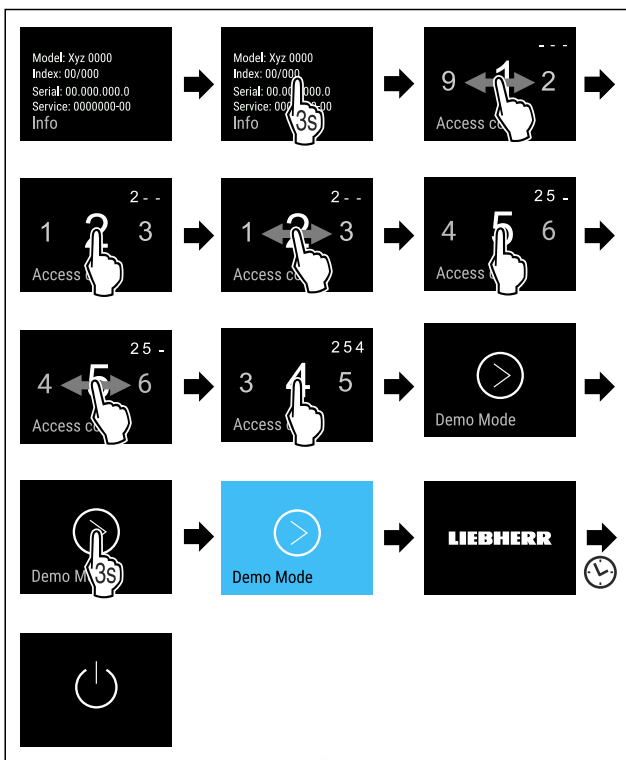

Fig. 73

- ▶ Carry out action steps according to the illustration.
- ▶ Demo mode is activated.
- ▶ Appliance is switched off.
- ▶ Switch on the appliance. (see 4.1 Switching on appliance (first use))
- ▶ “DEMO” appears in the status display.

Deactivating demo mode

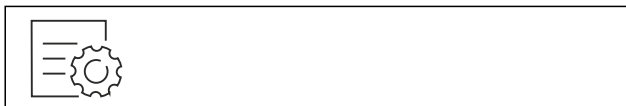

Fig. 74

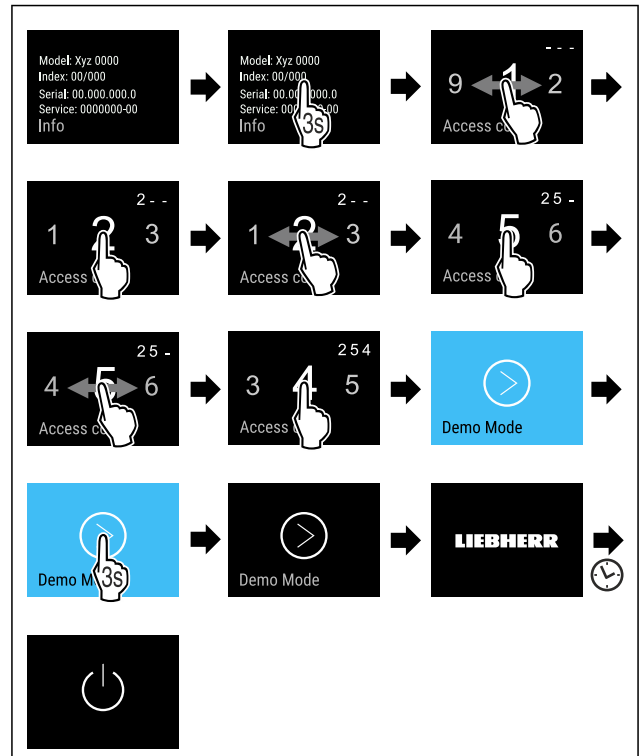

Fig. 75

- ▶ Carry out action steps according to the illustration.
- ▶ Demo mode is deactivated.
- ▶ Appliance is switched off.
- ▶ Switch on the appliance. (see 4.1 Switching on appliance (first use))
- ▶ Appliance is reset to factory settings.

Resetting to factory settings

Use this function to reset all settings to factory defaults. All settings you have made so far are reset to their original settings.

Performing a reset



Fig. 76

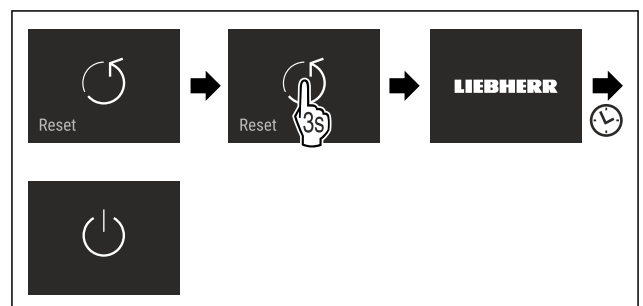

Fig. 77

- ▶ Carry out action steps according to the illustration.
- ▶ Device is reset.
- ▶ Device is switched off.
- ▶ Restart the device. (see 4.1 Switching on appliance (first use))

7.3 Messages





There are two categories of messages:

Category	Importance
Warning	Warnings appear in the event of a door alarm or malfunction. Simple warnings can be cancelled by yourself. In the event of serious malfunctions, you must contact customer service. (see 10.4 Customer Service)
Reminder	Reminders remind you of general processes. You can carry out these operations to end the message.

7.3.1 Overview of warnings

Behaviour of the appliance in the event of warnings:

- Warning appears in red on the display.
- The alarm tone sounds at an ever-increasing volume.
- The interior lighting pulsates for some warnings.

Message	Cause	Exit the message
 Door alarm	The message appears if the door is open for too long.	Carry out action steps (see Door alarm).
 Power alarm outage	The message appears if the freezing temperature has risen due to a power failure.	
 Temperature alarm	The message appears if the freezing temperature does not correspond to the set temperature.	Carry out action steps (see Temperature alarm).
 Error	The message appears if there is an appliance error. A component of the appliance has a fault.	Carry out action steps (see Error).

7.3.2 Ending warnings

Door alarm

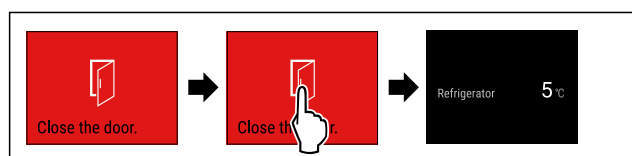

Fig. 78 Example illustration

- ▶ Carry out action steps according to the illustration.

-or-

- ▶ Close the door.

- ▶ The display returns to the status indicator.

You can set how long the door may be open before the door alarm sounds. (see Setting the door alarm)

Power outage alarm

When the power failure has ended, the appliance will automatically cool down to the previously set target temperature without you having to confirm the message. However, for the message to disappear from the display, you must confirm it.

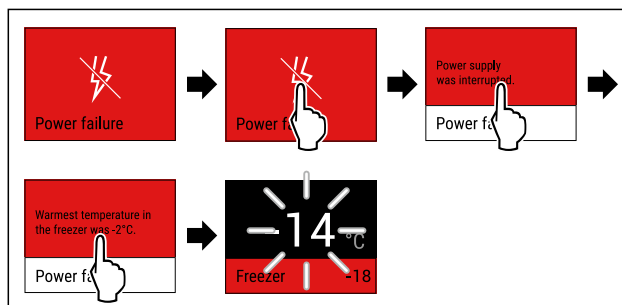

Fig. 79 Example illustration

- ▶ Briefly touch the display.
- ▶ Display shows information about the warning.
- ▶ Briefly touch the display.
- ▶ Warmest freezing temperature is displayed.
- ▶ If the freezing temperature was below $-9\text{ }^{\circ}\text{C}$: Food can still be consumed.
If the freezing temperature has risen above $-9\text{ }^{\circ}\text{C}$:
▶ Check the food.
- ▶ Briefly touch the display.
- ▶ The display returns to the status indicator: Current temperature and target temperature are displayed.

Temperature alarm

Temperature differences can be caused by:

- You have put in warm, fresh food.
- Too much warm air has got in while you were sorting out the freezer or removing items.
- There has been a longer power failure.
- The appliance is faulty.
- ▶ Eliminate causes.
- ▶ The appliance cools to the target temperature set previously.

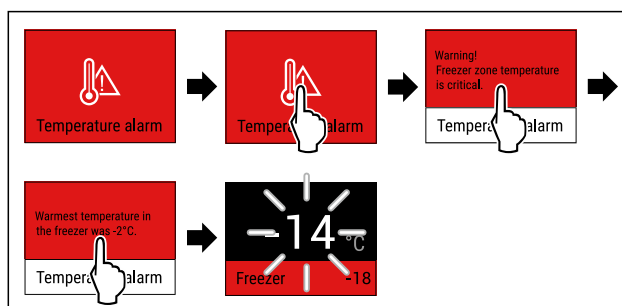

Fig. 80 Example illustration

- ▶ Briefly touch the display.
- ▶ Display shows information about the warning.
- ▶ Briefly touch the display.
- ▶ Warmest freezing temperature is displayed.
- ▶ If the freezing temperature was below $-9\text{ }^{\circ}\text{C}$: Food can still be consumed.
If the freezing temperature has risen above $-9\text{ }^{\circ}\text{C}$:
▶ Check the food.
- ▶ Briefly touch the display.
- ▶ The display returns to the status indicator: Current temperature and target temperature are displayed.

Features

Error

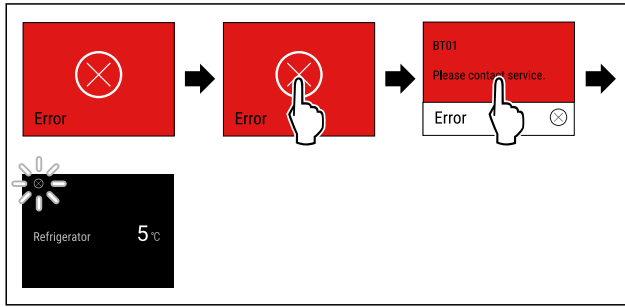

Fig. 81 Example illustration



- ▶ Briefly touch the display.
- ▶ Error code is displayed.
- ▶ Note the error code.
- ▶ Briefly touch the display.
- ▶ The display returns to the status indicator.
- ▶ Contact Customer Service. (see 10.4 Customer Service)

7.3.3 Overview of reminders

Behaviour of the appliance during reminders:

- Reminder appears yellow on the display.
- Alarm tone sounds.
- The interior lighting pulsates for some reminders.

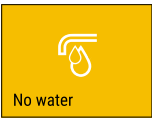
The following reminders can be deactivated :

Message	Cause	Exit the message
 No water Check the water connection	The message appears if the IceMaker is activated but the water connection is not being supplied with water via the fixed water connection.	Carry out action steps (see Check the water connection).
 No Drawer Insert the IceMaker drawer	The message appears if the IceMaker is activated but the IceMaker drawer is open.	Carry out action steps (see Insert the IceMaker drawer).

7.3.4 Ending reminders

Check the water connection

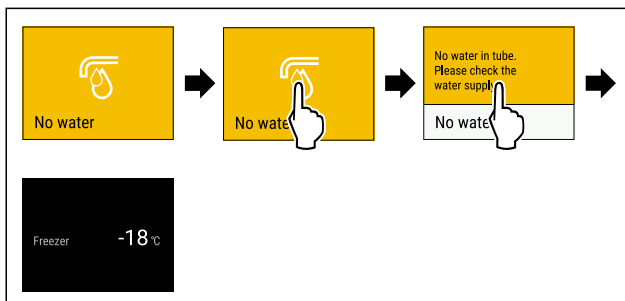

Fig. 82 Example illustration

- ▶ Briefly touch the display
 - ▶ Display shows reminder information.
 - ▶ Briefly touch the display
 - ▶ Check the water connection.
- or-
- ▶ Deactivate IceMaker. (see Deactivating the IceMaker and MaxIce)

- If water connection is checked and IceMaker is activated:
- ▶ Clean the IceMaker. (see 9.3.4 Cleaning the IceMaker)
 - ▶ IceMaker produces ice cubes.

Insert the IceMaker drawer

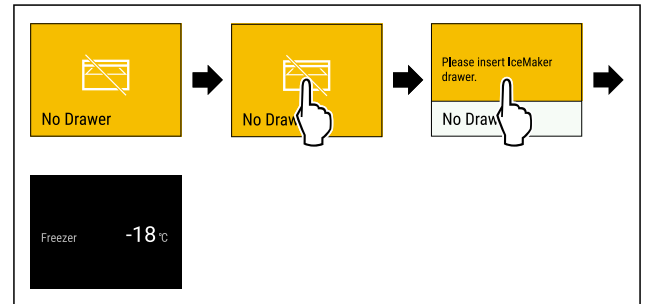

Fig. 83 Example illustration

- ▶ Briefly touch the display.
 - ▶ Display shows reminder information.
 - ▶ Briefly touch the display.
 - ▶ Insert the IceMaker drawer.
- or-
- ▶ Deactivate IceMaker. (see IceMaker / MaxIce)
- ▶ If IceMaker drawer is inserted and IceMaker is activated: IceMaker produces ice cubes.

8 Features

8.1 Drawers

You can remove the drawers for cleaning.

You can remove the drawers to use VarioSpace.

The way to remove/insert the drawers varies depending on the pull-out system. Your appliance can contain various pull-out systems.

Note

The energy consumption increases and the cooling power goes down if ventilation is not sufficient.

- ▶ Leave the bottom drawer in the appliance!
- ▶ Always leave the fan air vents clear on the back wall!

8.1.1 Drawer on appliance base or glass shelf

The drawer runs directly on the appliance base or on a glass shelf. There are no rails.

When you remove the drawers, you can use the glass shelves below them as storage shelves.

Removing drawer

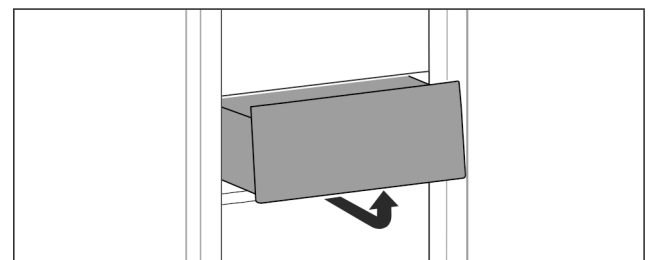

Fig. 84

- ▶ Remove drawer as shown in the illustration.

Inserting drawer

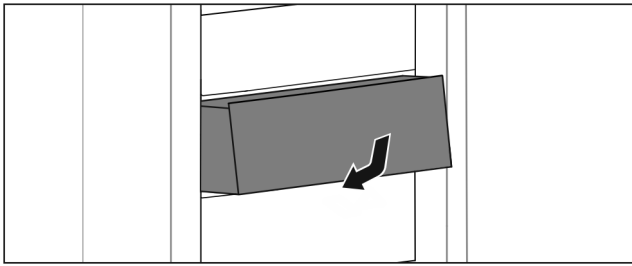

Fig. 85

- ▶ Insert drawer as shown in the illustration.

8.1.2 Drawer on telescopic rails

The drawer runs on extendible rails (telescopic rails). There are fully extendible telescopic rails and telescopic rails with partial pull-out. Drawers which are fully extendible can be pulled out fully from the appliance. Drawers with partial pull-out cannot be removed fully from the appliance. The system in your appliance depends on the type of appliance.

Drawer on glass shelf

The drawer guided on a glass shelf is a partial pull-out.

Removing drawer

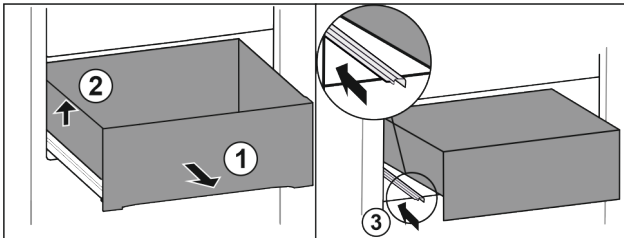

Fig. 86

- ▶ Pull out drawer as far as it will go. Fig. 86 (1)
- ▶ Lift drawer on the left. Fig. 86 (2)
- ▶ Insert left rail. Fig. 86 (3)

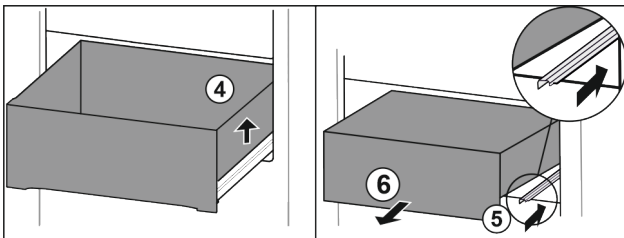

Fig. 87

- ▶ Lift drawer on the right. Fig. 87 (4)
- ▶ Insert right rail. Fig. 87 (5)
- ▶ Remove drawer to the front. Fig. 87 (6)

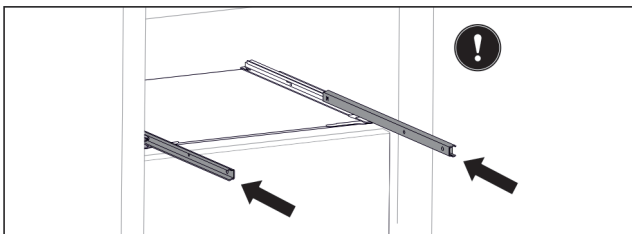

Fig. 88

If the rails are not yet fully inserted after removing the drawer:

- ▶ Push rails in completely.

Inserting drawer

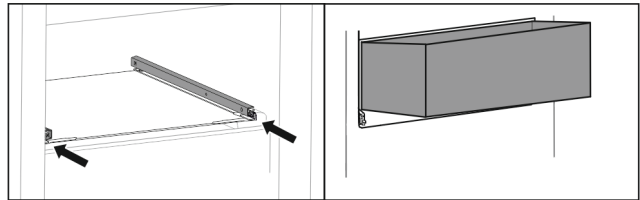

Fig. 89

- ▶ Slide rails in.
- ▶ Place drawer on rails at an angle.

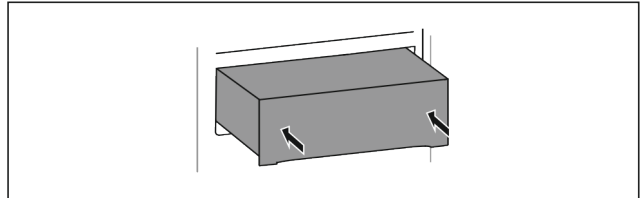

Fig. 90

- ▶ Lower drawer.
- ▶ Slide in drawer to the back.

8.1.3 Top tilting drawer

When you pull out the top drawer, it tilts forward. This gives you a better view into the drawer. The function depends on the height of the appliance.

When you remove the tilting drawers, you can use the glass shelf below them as a storage shelf.

Removing drawer

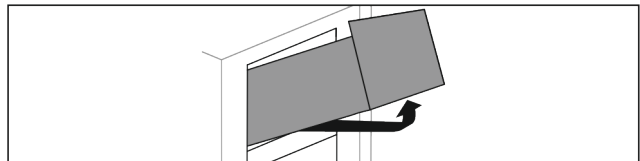

Fig. 91

- ▶ Pull out drawer as far as it will go.
- ▶ Lift drawer up at the front and at the same time push up at the back from below.
- ▶ Remove drawer to the front.

Inserting drawer

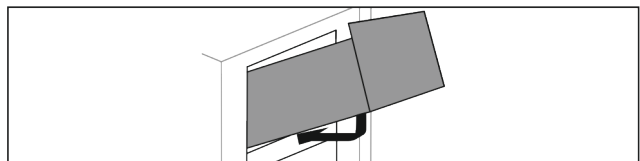

Fig. 92

- ▶ Position drawer as shown.
- ▶ The drawer rests on the glass panel.
- ▶ Lift drawer slightly from below at the back and slide over the lip.
- ▶ Slide in drawer to the back.

8.1.4 Drawer on moulded rib

The drawer runs directly on the moulded rib. There are no rails.

Features

Removing drawer

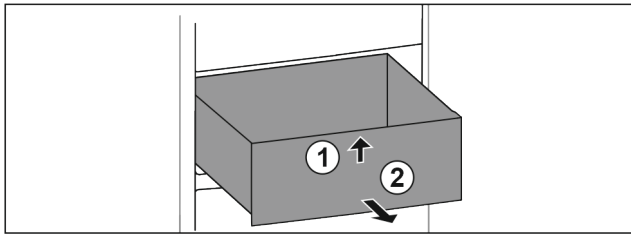

Fig. 93

- ▶ Pull out drawer as far as it will go.
- ▶ Lift up drawer at the front. Fig. 93 (1)
- ▶ Remove drawer to the front. Fig. 93 (2)

Inserting drawer

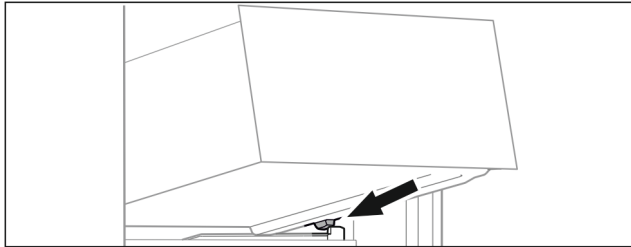

Fig. 94

- ▶ Place drawer at an angle behind the stoppers on the moulded rib. (see Fig. 94)
- ▶ Lower drawer.
- ▶ Slide in drawer to the back.

8.2 Pull-out board with IceTower

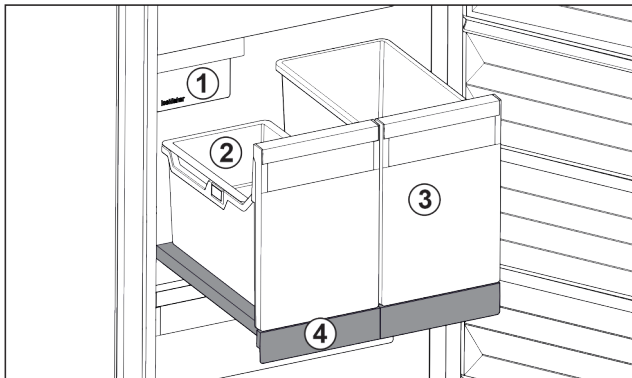

Fig. 95 Pull-out board with IceTower

- | | |
|--------------------------------|---|
| (1) IceMaker | (3) Container for pizza or alcoholic beverages, for example |
| (2) Hang-on tray for ice cubes | (4) Pull-out board |

There are two high (IceTower) containers on the pull-out board. Ice cubes from the IceMaker are collected and stored in the Fig. 95 (2) container. The container Fig. 95 (3) is suitable for storing tall foodstuffs or beverages such as pizzas or alcoholic drinks.

The pull-out board with IceTower is mounted on a glass shelf with pull-out rails. You can dismantle the pull-out board for cleaning.

8.2.1 Dismantling the pull-out board with IceTower

Removing the container

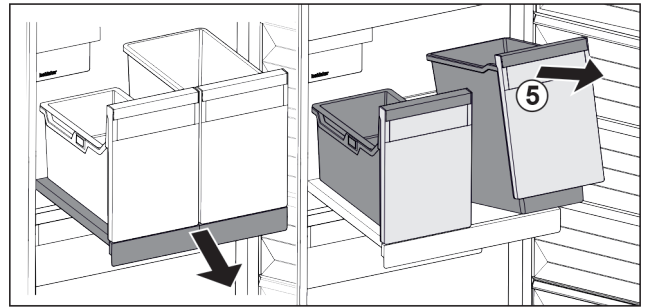

Fig. 96

- ▶ Pull out the pull-out board.
- ▶ Lift the container Fig. 96 (5) at the front.
- ▶ Remove the container.

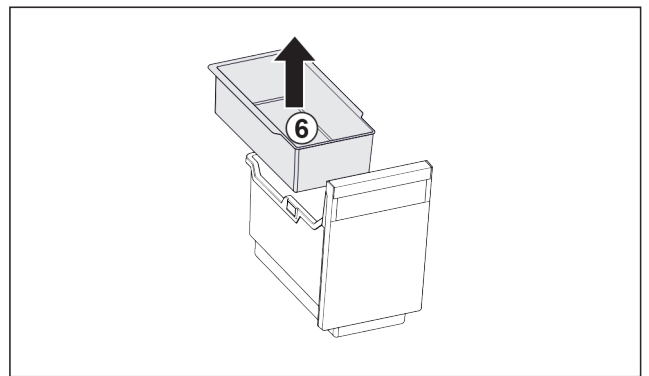

Fig. 97

- ▶ Remove the hang-on tray Fig. 97 (6).
- ▶ If there are ice cubes in the hang-on tray: Empty the hang-on tray.
- ▶ The container and hang-on tray have been removed and you can clean them. (see 9.3.3 Clean the components)

Removing the pull-out board

Ensure that the following conditions are met:

- Containers have been removed. (see Removing the container)

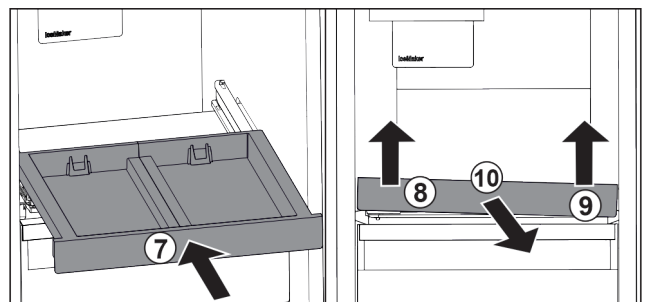

Fig. 98

- ▶ Slide in the pull-out board. Fig. 98 (7)
- ▶ Lift the pull-out board on the front left. Fig. 98 (8)
- ▶ Lift the pull-out board on the front right. Fig. 98 (9)
- ▶ Pull-out board is detached from the attachment at the front.
- ▶ Take out the pull-out board to the front. Fig. 98 (10)
- ▶ The pull-out board has been removed and you can clean it. (see 9.3.3 Clean the components)

Removing the glass shelf from under the pull-out board

(see 8.3 Glass shelves)

8.2.2 Inserting the pull-out board with IceTower

Inserting the glass shelf from under the pull-out board

(see 8.3 Glass shelves)

Inserting the pull-out board

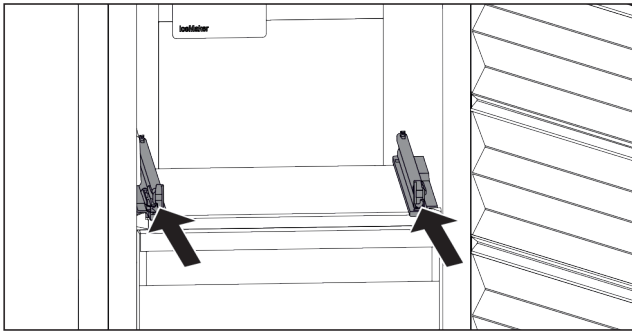

Fig. 99

- ▶ Slide the rails in.

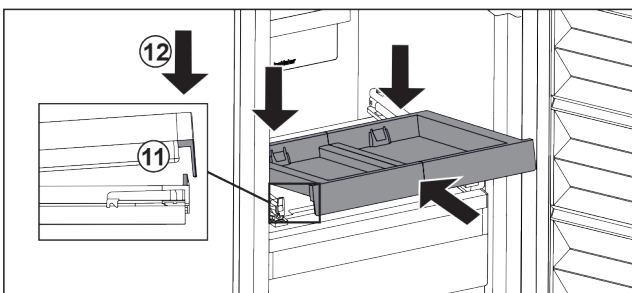

Fig. 100

- ▶ Place the pull-out board in at an angle behind the front lug.
- ▶ Slide in at an angle. Make sure that the stop is behind the lug on both sides. Fig. 100 (11)
- ▶ Lower the pull-out board at the front. Fig. 100 (12)

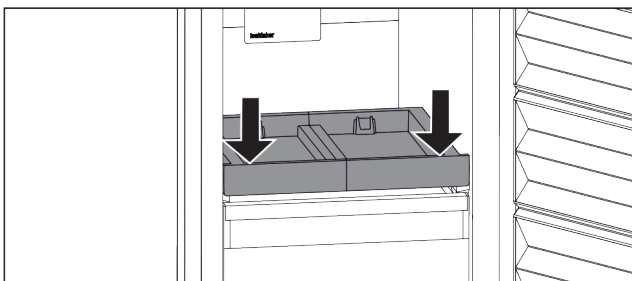

Fig. 101

- ▶ Push the pull-out board down at the front.
- ▶ Pull-out board clicks into place.

Inserting the container

Ensure that the following conditions are met:

- The pull-out board is inserted. (see Inserting the pull-out board)

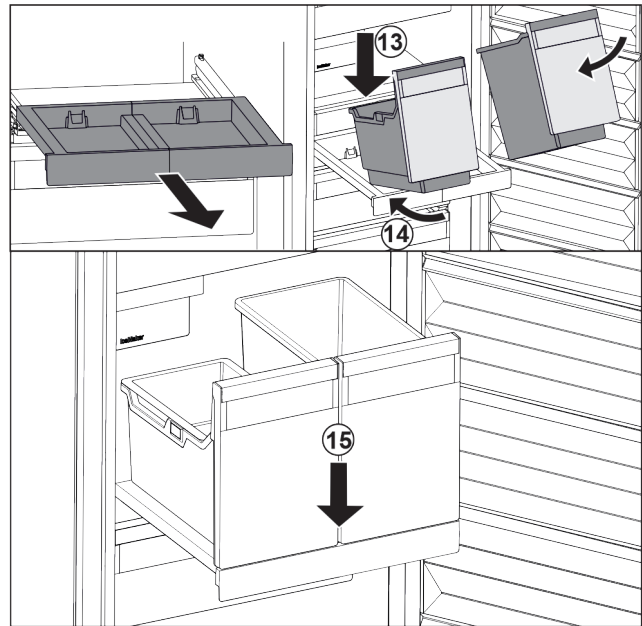

Fig. 102

- ▶ Pull out the pull-out board.
- ▶ Hold the pull-out board with one hand.

Note

The containers are shaped in a way that they cannot be interchanged.

- ▶ Place the container at an angle on the pull-out board. Fig. 102 (13)
- ▶ Slide the container to the back at an angle. Fig. 102 (14)
- ▶ Place container in the front. Fig. 102 (15)

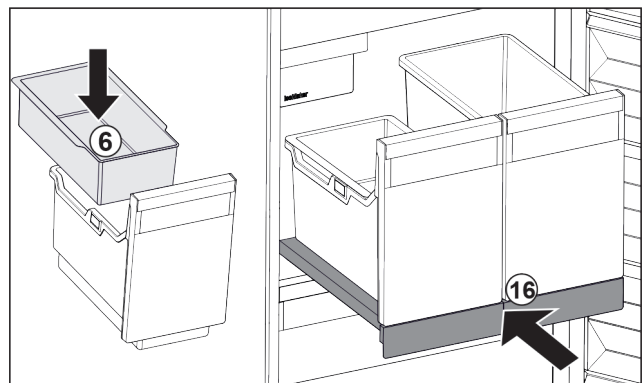

Fig. 103

- ▶ Insert hang-on tray Fig. 103 (6) for ice cubes.
- ▶ Slide in the pull-out board with (IceTower) container. Fig. 103 (16)
- ▶ Pull-out shelf with IceTower is fully inserted.

8.3 Glass shelves

NOTICE

Impermissible removal of the glass panel above the IceTower!

Damage to the IceMaker. The IceMaker is attached to the glass panel above the IceTower.

- ▶ Do not remove the glass panel above the IceTower.

You can remove the glass shelves under the drawers for cleaning.

You can remove the glass shelves under the drawers to use VarioSpace.

Features

8.3.1 Removing / inserting the glass shelf under the tilting drawer

The glass shelf is located under the top tilting drawer.

Make sure that the following requirements are fulfilled:

- ❑ Drawer has been removed. (see 8.1.3 Top tilting drawer)

Removing glass shelf

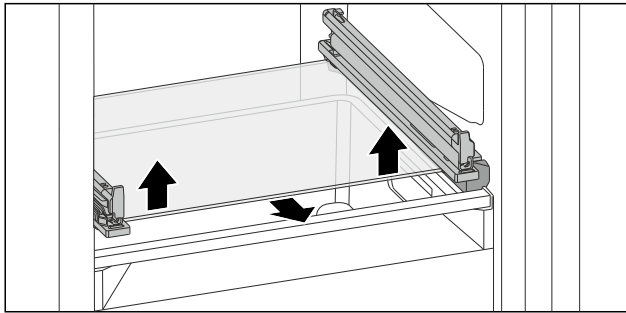

Fig. 104 Tilting drawer glass shelf

- ▶ Push glass shelf upwards from below on both sides. (see Fig. 104)
- ▶ Take out the glass shelf to the front.

Inserting glass shelf

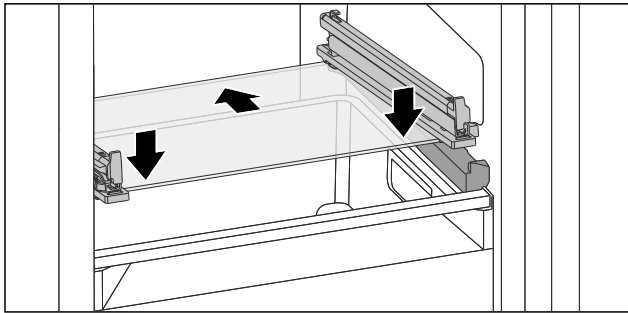

Fig. 105 Tilting drawer glass shelf

- ▶ Position glass shelf at an angle behind the stoppers. (see Fig. 105)
- ▶ Lower glass shelf.
- ▶ Slide in glass shelf to the back.
- ▶ Glass shelf clicks into place.

8.3.2 Removing / inserting the glass shelf

Depending on the equipment, the glass shelf may be located under the drawer.

Depending on the equipment, the glass shelf may be located under the IceTower.

Make sure that the following requirements are fulfilled:

- ❑ Glass shelf under the drawer: The drawer has been removed. (see 8.1 Drawers)
- ❑ Pull-out board under IceTower: IceTower has been removed. (see 8.2 Pull-out board with IceTower)

Removing glass shelf

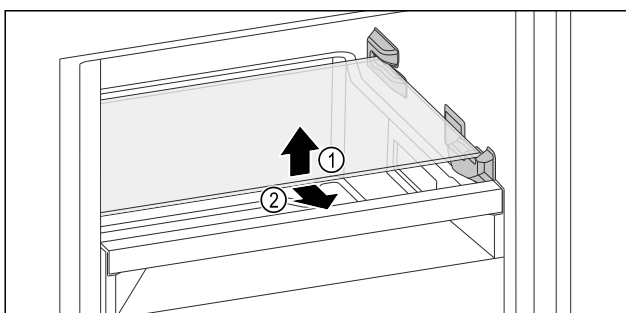

Fig. 106 Example illustration, glass shelf*

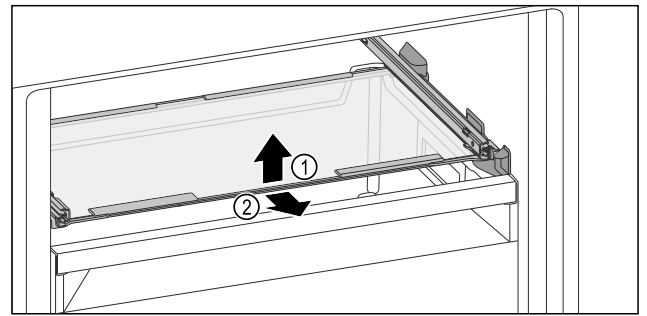

Fig. 107 Example illustration, glass shelf*

- ▶ Lift the glass shelf forwards.
- ▶ Remove the glass shelf forwards.

Inserting glass shelf

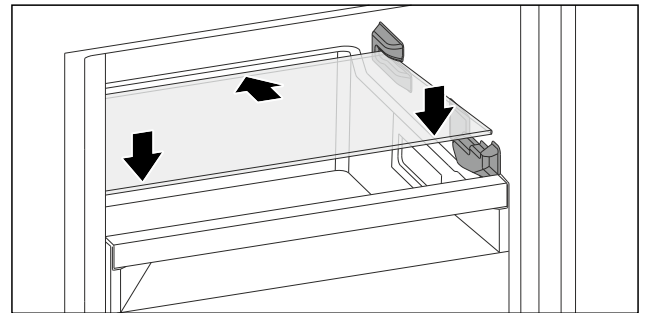

Fig. 108 Example illustration, glass shelf*

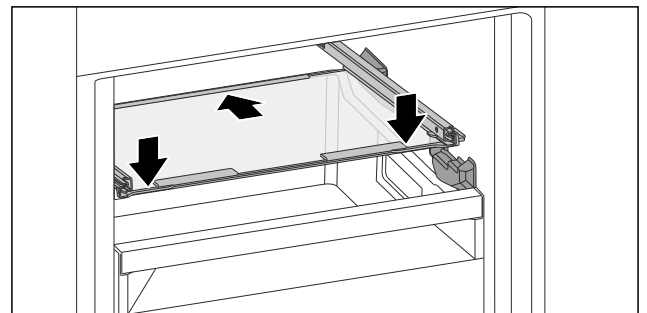

Fig. 109 Example illustration, glass shelf*

- ▶ Place the glass shelf at an angle behind the stoppers.
- ▶ Lower glass shelf.
- ▶ Slide in glass shelf to the back.

8.4 IceMaker

The IceMaker will produce ice cubes for household use only.

Ensure that the following conditions are met:

- The IceMaker is clean. (see 9 Maintenance)
- IceMaker drawer is cleaned.
- IceMaker drawer is fully inserted.

8.4.1 Producing ice cubes

The volume depends on the freezing temperature. The colder the temperature, the more ice cubes the system can produce in a certain time period.

After the IceMaker is turned on for the first time, it can take up to 24 hours for the first ice cubes to be made.

- ▶ Activate the IceMaker function.
- ▶ Producing many ice cubes: Activate the MaxIce function.
- ▶ To make a high number of ice cubes: Move the divider in the IceMaker drawer or remove it completely.
- ▶ Distribute the ice cubes evenly in the drawer to increase the capacity.

- ▶ Closing the drawer: IceMaker starts making ice cubes again automatically.

Note

When a certain level is reached in the IceMaker drawer, it stops producing ice cubes. The IceMaker does not fill the drawer all the way to the top.

8.5 VarioSpace

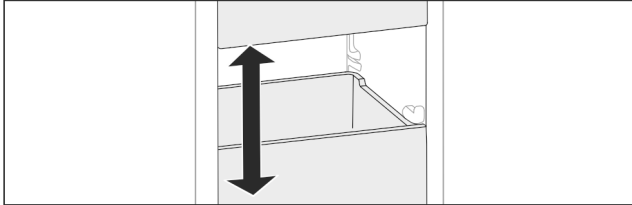

Fig. 110

You can remove drawers and glass panels from your appliance. This provides more room for large food items such as poultry, joints of meat, large game, and tall baked products. You can then freeze these items whole for later preparation.

- ▶ Note the weight limits on the drawers and glass panels (see 10.1 Technical specifications).

8.6 Freezer pack

Freezer packs prevent the temperature rising too quickly should there be a power cut.

The freezer packs are in the drawer.

You can store the freezer packs in the freezer tray.

8.6.1 Using the freezer pack

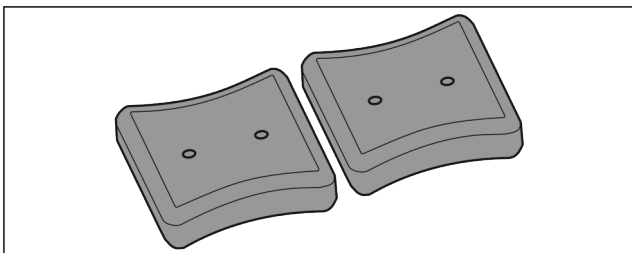

Fig. 111

When the freezer packs are fully frozen:

- ▶ Place on the frozen goods in the top, front part of the freezer.

8.7 Flexible ice compartment divider

The IceMaker's ice cube drawer has a flexible ice compartment divider. This allows you to store larger quantities of ice cubes or additional food items as needed. You can move or remove the ice compartment divider.

8.7.1 Moving in the flexible ice compartment divider

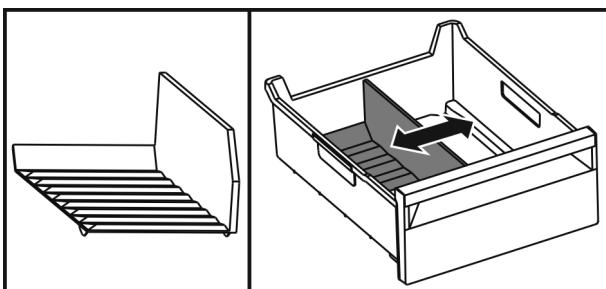

Fig. 112 Example illustration of the ice compartment divider

- ▶ Move the ice compartment divider to the desired position.

8.7.2 Removing the flexible ice compartment divider

Make sure that the following requirements are fulfilled:

- ❑ Ice cube drawer is removed. (see 8.1 Drawers)

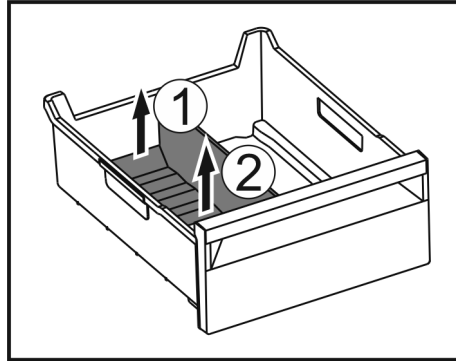

Fig. 113

- ▶ Lift the rear part of the ice compartment divider. Fig. 113 (1)
- ▶ Remove the ice compartment divider upwards. Fig. 113 (2)

8.7.3 Putting in the flexible ice compartment divider

Make sure that the following requirements are fulfilled:

- ❑ Ice cube drawer is removed. (see 8.1 Drawers)

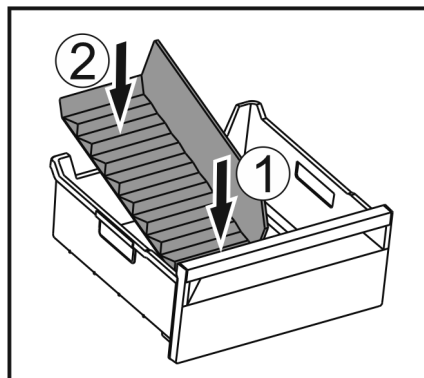

Fig. 114

- ▶ Insert the front part of the ice compartment divider. Fig. 114 (1)
- ▶ Lower the rear part of the ice compartment divider to the drawer bottom. Fig. 114 (2)

9 Maintenance

9.1 Disassembling / assembling pull-out systems

9.1.1 Notes on disassembly

You can disassemble some of the pull-out systems for cleaning. Your appliance can contain a variety of pull-out systems.

The following pull-out systems can be disassembled or cannot be disassembled:

Maintenance

Pull-out system	can be disassembled / cannot be disassembled
Drawer on appliance base or glass shelf	cannot be disassembled
Drawer guided on glass shelf	can be disassembled (see Drawer on glass shelf)
Top tiltable drawer	can be disassembled (see 9.1.3 Top tilting drawer)
Drawer guided on container rib	can be disassembled (see 9.1.4 Drawer on moulded rib)
IceTower	can be disassembled (see 9.1.5 IceTower)

9.1.2 Drawer on telescopic rails

Drawer on glass shelf

Disassembling pull-out system

Make sure the following prerequisites are met:

- Drawer has been removed.
- Glass shelf has been removed. (see 8.3 Glass shelves)

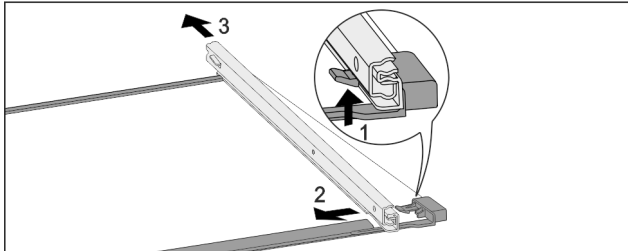

Fig. 115 Glass shelf with rails

- ▶ Push up front click-in hooks. (1)
- ▶ Move pull-out rails to the side (2) and to the rear (3).

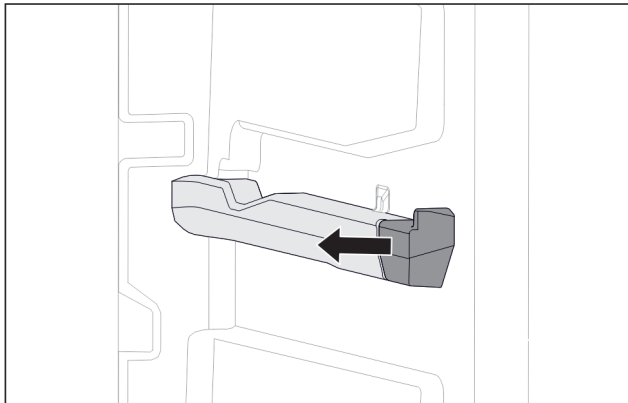

Fig. 116 Attachment on the right moulded rib

- ▶ Remove moulded rib attachment sideways.

Installing pull-out system

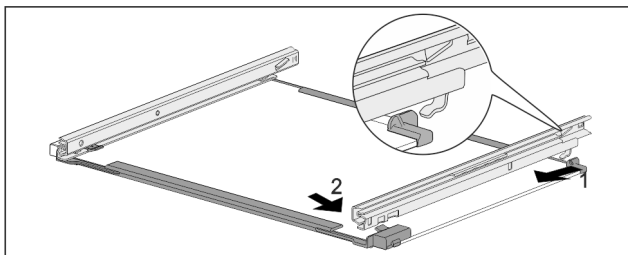

Fig. 117 Glass shelf with rails

- ▶ Hook in rail at the back. (1)
- ▶ Hook in rail at the front. (2)

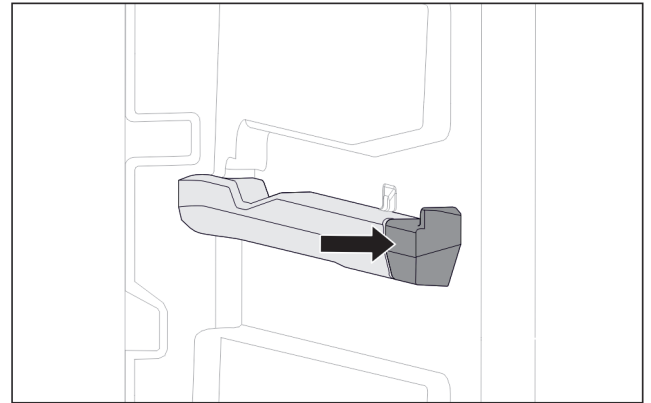

Fig. 118 Attachment on the right moulded rib

- ▶ Press attachment onto moulded rib.

9.1.3 Top tilting drawer

Disassembling pull-out system

Make sure the following prerequisites are met:

- Drawer has been removed. (see 8.1.3 Top tilting drawer)
- Glass shelf has been removed. (see 8.3 Glass shelves)

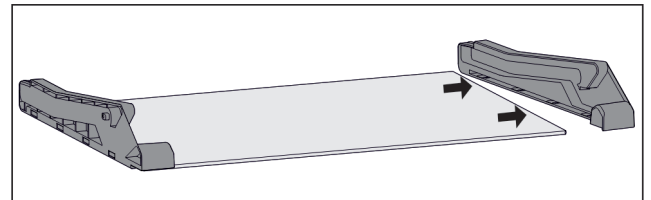

Fig. 119 Glass shelf with side parts

- ▶ Pull off side part from glass shelf sideways.

Installing pull-out system

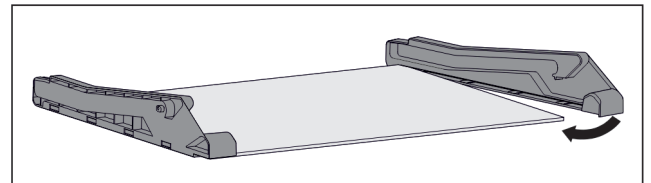

Fig. 120 Glass shelf with side parts

- ▶ Place on side part at the back.
- ▶ Press side part onto glass shelf at the front.

9.1.4 Drawer on moulded rib

Disassembling pull-out system

Make sure the following prerequisites are met:

- Drawer has been removed. (see 8.1.4 Drawer on moulded rib)

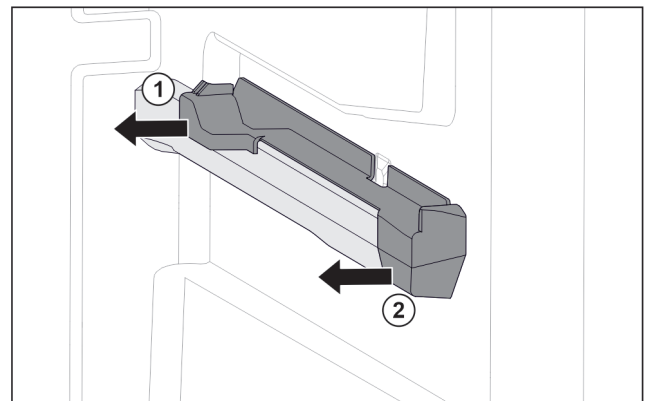

Fig. 121 Attachment on the right moulded rib

- ▶ Grab attachment at the back from below.

- ▶ Pull off attachment at the back sideways. *Fig. 121 (1)*
- ▶ Pull off attachment at the front sideways. *Fig. 121 (2)*

Installing pull-out system

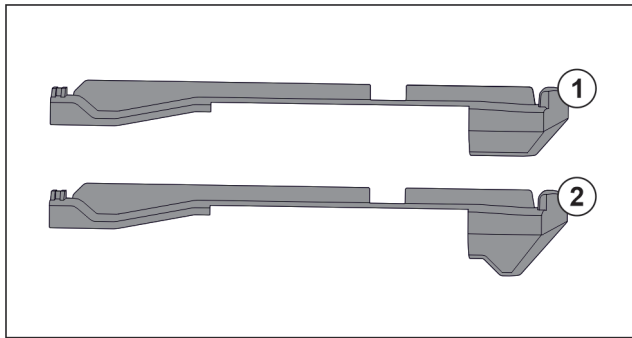

Fig. 122 Comparing attachments

There are two different attachments in the appliance. The attachment above the lowest drawer *Fig. 122 (2)* has a three-cornered edge. All other attachments *Fig. 122 (1)* have a straight edge.

- ▶ Fit attachment *Fig. 122 (2)* with the three-cornered edge above the lowest drawer.
- ▶ Fit attachment *Fig. 122 (1)* with straight edge in all other positions.

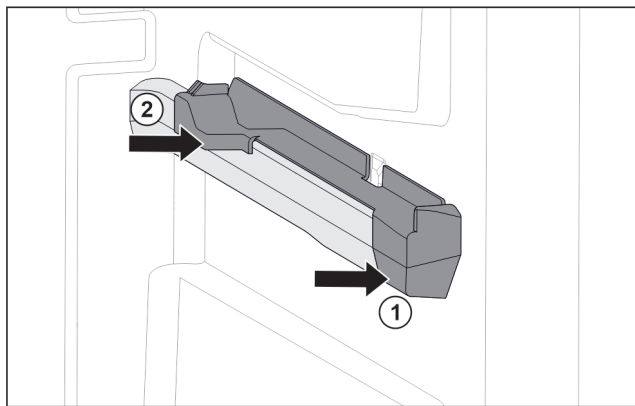

Fig. 123 Attachment on the right moulded rib

- ▶ Position attachment on moulded rib at the front. *Fig. 123 (1)*
- ▶ Press on attachment at the back. *Fig. 123 (2)*

9.1.5 IceTower

Disassembling pull-out system

Make sure the following prerequisites are met:

- IceTower has been removed. (see 8.2 Pull-out board with IceTower)
- Glass shelf has been removed. (see 8.3 Glass shelves)
- ▶ Place pull-out board on a table.
- ▶ You are able to remove the rails more easily from the glass shelf.

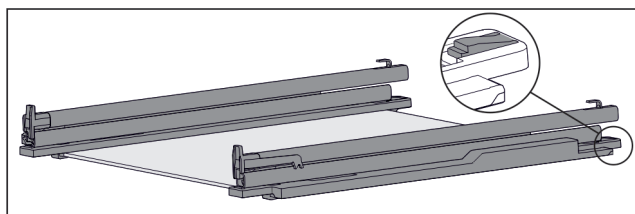

Fig. 124 Glass shelf with rails and retaining parts

- ▶ Press down retaining part at the rear (see *Fig. 124*) and at the same time push the rail back.

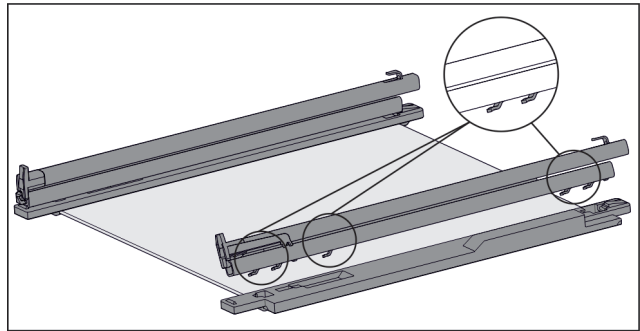

Fig. 125 Glass shelf with rails and retaining parts

- ▶ The rail hooks are released from the retaining part.
- ▶ Remove rail from retaining part.

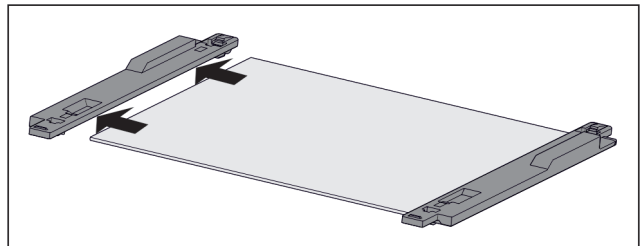

Fig. 126 Glass shelf with retaining part

- ▶ Remove retaining part from glass shelf sideways.

Installing pull-out system

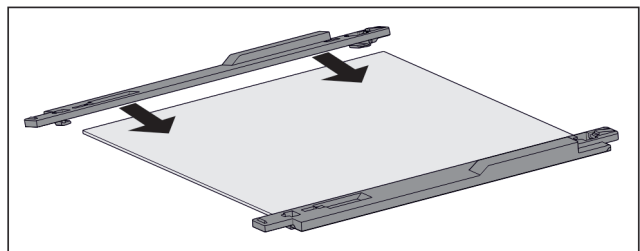

Fig. 127 Glass shelf with retaining part

- ▶ Fit retaining part on glass shelf.
- ▶ Push retaining part onto glass shelf as far as it will go.

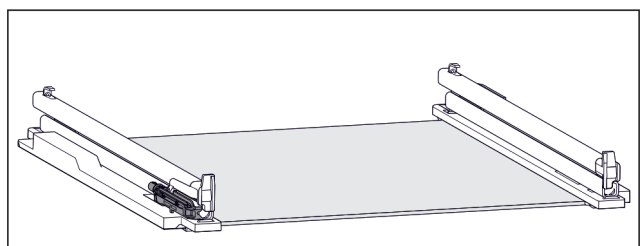

Fig. 128 Damping mechanism

The damping mechanism is attached to the left rail. (see *Fig. 128*) There is no damping mechanism attached to the right rail.

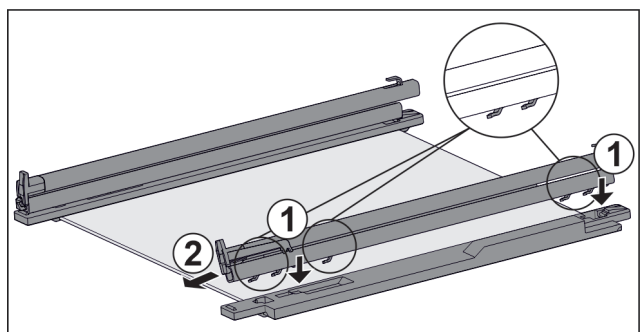

Fig. 129 Glass shelf with rails and retaining parts

Install rail **with** damping mechanism:

Customer help

- ▶ Place rail hooks onto the openings of the **left** retaining part. *Fig. 129 (1)*
- ▶ Push rail forwards. *Fig. 129 (2)*
- ▶ Rail latches in audibly.
Install rail **without** damping mechanism:
- ▶ Place rail hooks onto the openings of the **right** retaining part. *Fig. 129 (1)*
- ▶ Push rail forwards. *Fig. 129 (2)*
- ▶ Rail latches in audibly.

9.2 Defrosting the appliance

9.2.1 Defrosting with NoFrost

Defrosting is performed automatically with the NoFrost system. The moisture is deposited on the evaporator, is periodically defrosted and evaporates.

The appliance does not have to be defrosted.

9.3 Cleaning the appliance

9.3.1 Ready



WARNING

Danger of electric shock!

- ▶ Remove the refrigerator connector or interrupt the power supply.



WARNING

Risk of fire

- ▶ Do not damage the refrigeration circuit.

- ▶ Empty the appliance.
- ▶ Remove mains connector.

9.3.2 Cleaning the interior

NOTICE

Improper cleaning!

Damage to the appliance.

- ▶ Only use soft cleaning cloths and ph-neutral all-purpose cleaners.
- ▶ Do not use abrasive sponges or steel wool which may cause scratches.
- ▶ Do not use any sharp or abrasive cleaning agents, nor any that contain sand, chloride or acid.

- ▶ Plastic surfaces: clean by hand with a soft clean cloth, lukewarm water and a little detergent.
- ▶ Metal surfaces: clean by hand with a soft clean cloth, lukewarm water and a little detergent.

9.3.3 Clean the components

NOTICE

Improper cleaning!

Damage to the appliance.

- ▶ Only use soft cleaning cloths and ph-neutral all-purpose cleaners.
- ▶ Do not use abrasive sponges or steel wool which may cause scratches.
- ▶ Do not use any sharp or abrasive cleaning agents, nor any that contain sand, chloride or acid.

Clean with a soft, clean cloth, lukewarm water and some detergent:

- IceTower pull-out board
- Drawer

Please note: Do not remove the magnet on the drawer. The magnet ensures the functionality of the IceMaker.

- Flexible ice compartment divider in the IceMaker's ice cube drawer
- Freezer tray

Clean with a damp cloth:

- Retractable rails
Please note: The grease in the tracks is used for lubrication and must not be removed!

Wash in the dishwasher up to 60 °C:

- Ice cube scoop
- ▶ To disassemble components: see the relevant section.
- ▶ Clean the components.

9.3.4 Cleaning the IceMaker

There are various options for cleaning the IceMaker.

Cleaning is required in the following cases:

- Initial operation
- With mains connection:
If out of use for more than 5 days.

Ensure that the following conditions are met:

- IceMaker drawer is emptied.
- IceMaker drawer is in place.
- The IceMaker is activated.

First use or after a long period of non-use

Clean the IceMaker with the TubeClean function.

- ▶ Put an empty 1.5 l vessel (max. height 10 cm) in the drawer under the IceMaker.
- ▶ Activate the TubeClean function.
- ▶ The rinse process is prepared (max. 60 min.): Symbol flashes.
- ▶ Water pipes are rinsed: Symbol flashes.
- ▶ Rinsing process is complete: Function turns off automatically.
- ▶ Remove the IceMaker drawer and remove the container.
- ▶ Clean the IceMaker drawer with warm water and a little detergent.
- ▶ Push the IceMaker drawer in.
- ▶ The system starts making ice cubes automatically.

Without a water filter

- ▶ Dispose of any ice cubes that were made 24 hours after the first ice cubes.

If cleaning is required

Clean the IceMaker by hand.

- ▶ Remove the IceMaker drawer and clean with warm water and a little detergent.
- ▶ Push the IceMaker drawer in.
- ▶ The system starts making ice cubes automatically.

9.3.5 After cleaning

- ▶ Wipe the appliance and the components dry.
- ▶ Connect and switch on the appliance.
- ▶ Activate SuperFrost (see 7.2 Appliance functions) .
The temperature is cold enough:
- ▶ Place the food inside.
- ▶ Repeat cleaning regularly.

10 Customer help

10.1 Technical specifications

Temperature range	
Freeze	-28 °C to -15 °C

Maximum ice cube quantity / 24 hours	
Freezer compartment	see type plate under "Freezing capacity .../ 24 h"

Maximum component capacity			
Features	Appliance width 550 mm (see installation instructions, appliance dimensions)	Appliance width 600 mm (see installation instructions, appliance dimensions)	Appliance width 700 mm (see installation instructions, appliance dimensions)
Drawer on glass shelf (see 8.1.1 Drawer on appliance base or glass shelf)	12 kg	15 kg	--
Drawer on container rib (see 8.1.4 Drawer on moulded rib)	14 kg	19 kg	19 kg
Drawer guided on glass shelf (see 8.1.2 Drawer on telescopic rails)	12 kg	15 kg	22 kg
Bottom drawer	--	11 kg	19 kg
Top tiltable drawer (see 8.1.3 Top tilting drawer)	--	19 kg	19 kg

Ice cube production with IceMaker*	
Ice cube production / 24 hours	At a temperature of -18 °C: 0.8 kg of ice cubes
maximum ice cube production / 24 hours	With the MaxIce function on: 1.2 kg of ice cubes

Ice cube production with IceMaker+*	
Ice cube production / 24 hours	At a temperature of -18 °C: 1.2 kg of ice cubes
maximum ice cube production / 24 hours	With the MaxIce function on: 1.6 kg of ice cubes

10.2 Operating noises

The appliance makes different noises when it is on.

- At **higher temperatures** the appliance uses less energy but works for longer. It is **quieter**.
- At **lower temperatures** the food is cooled faster. It is **louder**.

Defect	Cause	Remedy
The appliance is not working.	→ The appliance is not switched on.	► Switch the appliance on.

Examples:

- Functions on (see 7.2 Appliance functions)
- Fan running
- Food recently added
- High ambient temperature
- Door open for a while

Noise	Possible cause	Type of noise
Bubbling and splashing	Coolant flowing into the cooling circuit.	Normal operating noise
Hissing	Coolant sprays into the cooling circuit.	Normal operating noise
Humming	The appliance is cooling. The volume depends on the cooling output.	Normal operating noise
Suction noises	Soft-closing door is being opened and closed.	Normal operating noise
Humming and rustling	The fan is running.	Normal operating noise
Clicking	Components are switched on and off.	Normal switching noise
Rattling or humming	Valves or flaps are working.	Normal switching noise

Noise	Possible cause	Type of noise	Lifting
Vibration	Improper installation	Defective noise	Check the installation. Level the appliance.
Rattling	Components, items inside the appliance	Defective noise	Secure components. Leave enough space between the items.

10.3 Technical fault

Your appliance is designed and built to ensure it works reliably and has a long service life. In the unlikely event that a fault occurs during operation, please check whether it is due to an operating error. If so, you will be charged for the callout and repair costs even if it falls within the warranty period.

You can fix the following faults yourself.

10.3.1 Appliance function

Customer help

Defect	Cause	Remedy
	→ The power plug is not properly plugged into the socket.	▶ Check the power plug.
	→ There is something wrong with the power outlet fuse.	▶ Check the fuse.
	→ Power cut	▶ Keep the appliance closed. ▶ Safeguarding food: Place cold packs on top of food or use another freezer if the power cut lasts longer. ▶ Do not re-freeze defrosted food,
	→ The IEC socket is not plugged into the appliance correctly.	▶ Check the IEC socket.
Temperature is not cold enough.	→ The appliance door is not closed properly.	▶ Close the appliance door.
	→ Not enough ventilation.	▶ Keep ventilation grille clear, and clean it.
	→ The ambient temperature is too high.	▶ Problem solution: (see 2.4 Appliance range of use)
	→ The appliance was opened too many times or for too long.	▶ Wait to see if the required temperature corrects itself. If not, contact Customer Service. (see 10.4 Customer Service)
	→ Too much fresh food was placed inside without SuperFrost.	▶ Solution: (see SuperFrost)
	→ The temperature is set incorrectly.	▶ Turn down the temperature and check after 24 hours.
	→ The appliance is too close to a heat source (oven, radiator, etc).	▶ Move the appliance or the heat source.
The door seal is defective or needs to be replaced for another reason.	→ The appliance was not correctly installed in the recess.	▶ Check if the appliance was installed correctly and that the door closes properly.
	→ The door seal can be replaced. It can be replaced without the need for special tools.	▶ Contact Customer Service. (see 10.4 Customer Service)
The appliance builds up too much ice or condensation.	→ The door seal may have slipped out of its groove.	▶ Check that the door seal is well fitted in the groove.

10.3.2 Features

Defect	Cause	Remedy
You cannot activate the IceMaker.	→ The appliance and therefore the IceMaker are not connected.	▶ Connect the appliance (see the Installation Guide).
The IceMaker is not producing ice cubes.	→ The IceMaker is not on.	▶ Activate the IceMaker.
	→ The drawer of the IceMakers is not connected properly.	▶ Push the drawer in correctly.
	→ The water connection is not open.	▶ Open the water connection.
The internal light does not come on.	→ The appliance is not switched on.	▶ Switch the appliance on.
	→ The door was open for longer than 15 minutes.	▶ Interior lighting switches off automatically after about 15 minutes when the door is open.
	→ The LED interior light is faulty or the lid is damaged.	▶ Contact Customer Service. (see 10.4 Customer Service)

10.4 Customer Service

First check whether you can rectify the fault yourself (see 10 Customer help) . If you cannot rectify the problem, contact Customer Service.

You can find the address at home.liebherr.com/service.



WARNING

Unprofessional repair!
Injuries.

- ▶ Have any repairs and action - not expressly specified - on the appliance and mains cable carried out by service personnel only. (see 9 Maintenance)
- ▶ A damaged mains cable may only be replaced by the manufacturer, the manufacturer's Customer Service or a similarly qualified person.
- ▶ In the case of appliances with an IEC connector, the change may be made by the customer.

10.4.1 Contacting Customer Service

Make sure that the following appliance information is available:

- Appliance name (model and index)
 - Service no. (Service)
 - Serial no. (S no.)
 - ▶ Call up the appliance information via the display. (see Device information)
- or-**
- ▶ Refer to the type plate for appliance information. (see 10.5 Model plate)

- ▶ Note down the appliance information.
- ▶ Notify customer service: Report errors and the appliance information.
- ▶ This will help us to provide you with a faster, more accurate service.
- ▶ Follow further instructions from Customer Service.

10.5 Model plate

The model plate is behind the drawers on the inside of the appliance.

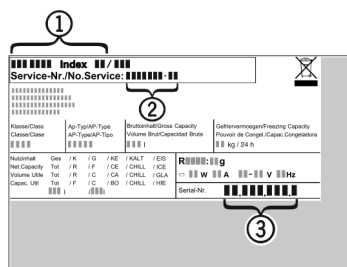

Fig. 130

- (1) Appliance description
- (2) Service no.
- (3) Serial no.

- ▶ Note the data on the model plate.

11 Shutting down

- ▶ Empty the appliance.
- ▶ Deactivate IceMaker. (see Deactivating the IceMaker and MaxIce)
- ▶ Switch off appliance. (see Switching the appliance off and on)
- ▶ Pull the mains plug out of the socket.
- ▶ Remove the IEC socket if required: Pull the IEC socket out of the appliance plug and move it to the left and right at the same time.

- ▶ Clean appliance. (see 9.3 Cleaning the appliance)
- ▶ Leave the door open, so that no unpleasant odours arise.

12 Disposal

12.1 Preparing appliance for disposal



Li-Ion

Liebherr uses batteries in some of its appliances. In the EU, for environmental reasons, legislation obliges the end user to remove these batteries before disposing of old appliances. If your appliance contains batteries, a corresponding notice is attached.

Lamps If you can remove the lamps yourself without destroying them, also remove these before disposal.

- ▶ Take the appliance out of operation.
- ▶ If possible: remove lamps without destroying them.

12.2 Disposing of the appliance in an environmentally friendly manner



The appliance still contains valuable materials and must be disposed of separately from unsorted municipal waste.



Li-Ion



Li-Ion

Dispose of batteries separately from the old appliance. To do this, you can return the batteries free of charge to retailers as well as recycling centres and collection centres for recyclable materials.

Lamps

Dispose of removed lamps via the respective collection systems.



WARNING

Leaking coolant and oil!

Fire. The coolant contained in the appliance is eco-friendly, but also flammable. The oil contained in the appliance is flammable. Escaping coolant and oil can ignite if the concentration is high enough and in contact with an external heat source.

- ▶ Do not damage the pipelines of the coolant circuit and the compressor.

- ▶ Observe the notes on transporting the appliance.
- ▶ Transport the appliance without damaging it.
- ▶ Dispose of batteries, lamps and the appliance according to the above specifications.



home.liebherr.com/fridge-manuals

EN Integrated freezer

Issue date: 20250612

Part number index: **7088448-0**
0