

# EFE 1552

---



# LIEBHERR

# Impulse Sales Chest Freezer



## Impulse Sales Chest Freezer

## EFE 1552

LED

<b>Total gross/net capacity</b> cu.ft. (l)	5.1 / 3.7 (145 / 105)
<b>Exterior dimensions</b> in inches (w/d/h) in mm (w/d/h)	24 5/8" / 26 13/16" / 32 1/2" 625 / 680 / 825
<b>Interior dimensions</b> in inches (w/d/h) in mm (w/d/h)	19 11/16" / 21 1/8" / 20 5/8" 500 / 535 / 523
<b>Total display area in m<sup>2</sup> (TDA) / ft<sup>2</sup></b>	0.30 / 3.22
Energy consumption in 365 days *	381 kWh
Ambient temperature in °F (°C)	50°F to 95°F (10°C to 35°C)
Refrigerant	R290
Sound rating **	42 dB(A)
Connection rating	2.5 A/188 W
Frequency / Voltage	60 Hz/115 – 127V~
Cooling system/Defrost	static/manual
Temperature range °F (°C)	14°F to -11°F (-10°C to -24°C)
Lid material	sliding glass lid
External cabinet finish	steel/white
Internal liner material	steel
Frame color	grey
Type of control/Temperature display	analog control/internal analogue
Interior light	LED
Number of baskets	2
Number of baskets, max (see picture)	2
Castors	swivel casters
Lock	can be retrofitted
Insulation in inches (mm)	2 3/8" (60)
Water drain	yes
Gross/net weight in lbs (kg)	106.9 / 93.9 (48.5 / 42.6)
<b>Accessories</b>	
Basket 270 mm	7111095
Basket 210 mm	7111097
Partition grid 270 mm	7111029
Partition grid 210 mm	7111784
Partition grid 195 mm	
Basket	
Rubber bumpers, grey	7266707
Cylinder lock for glass sliding lid	7043660
Scoop ice cream containers	on request
Baskets for scoop ice cream containers	on request
External thermostat dial	on request



## Unit Dimensions

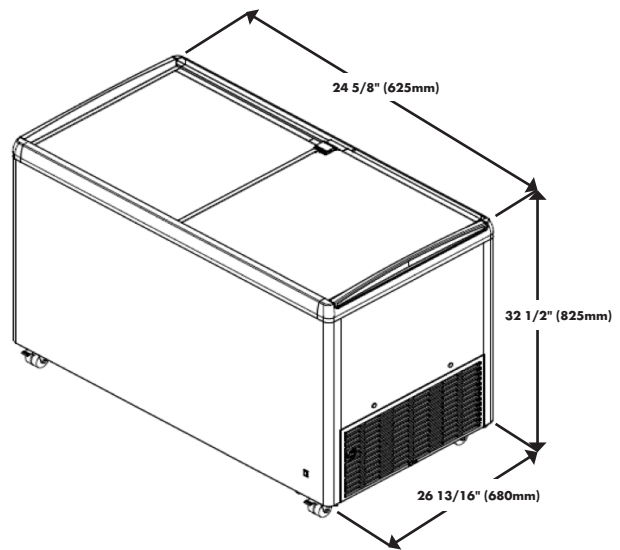

Subject to modification. For up-to-date information, visit [home.liebherr.com](http://home.liebherr.com).