

Crawler Excavator

R 926 Compact

Litronic®

Generation

6

Engine

175 HP / 129 kW

Tier 4 Final

Operating Weight

26,100 kg / 57,540 lb

Bucket Capacity

0.55 – 1.50 m³ / 0.72 – 1.96 yd³



LIEBHERR

Performance

Performance, Precision
and Responsiveness

Efficiency

High Level of Productivity for
a Lower Overall Operating Cost

Generation

6

Engine

175 HP / 129 kW

Tier 4 Final

Operating Weight

26,100 kg / 57,540 lb

Bucket Capacity

0.55 – 1.50 m³ / 0.72 – 1.96 yd³



Reliability

Result of Ongoing Improvements

Comfort

Spacious, Ergonomic and with High-visibility

Maintainability

Simplified Daily Checks, Longer Maintenance Intervals



Performance



**Performance, Precision
and Responsiveness**

High Productivity for Extraction and Loading

Boasting a rotation radius of 1.70 m/5' 7" at the rear and until than 1.90 m/6' 3" at the front, the R 926 Compact is perfectly stable and suitable for the narrowest of worksites. The exceptional hydraulic performance of Liebherr excavators means shorter work cycles and higher productivity for extraction and loading.

A Wide Range of Attachments

The R 926 excavator is suitable for all types of works, thanks to a wide range of Liebherr tools. Different sticks can be combined with a variety of booms (monoblock, offset monoblock and luffing booms). Finally, an optional dozer and stabilizer blade completes the versatility of the machine. Then, to make tool-changing easier, Liebherr offers a SWA quick-change attachment and the LIKUFIX system as options.

The Liebherr System Tool-Management

The Tool-Management function makes it easy to change tools thanks to the tool recognition RFID system. The programmed pressure and flow values are available from the moment the hydraulic tool is changed. This increases productivity thanks to the shorter fitting times.

Cutting-Edge Technology for Top-Level Performance

The R 926 crawler excavator incorporates Liebherr's Positive Control hydraulic system. This system is controlled by Liebherr electronics, using strategically-positioned sensors. All of the machine's work is therefore faster, more accurate and fluid. What's more, as the two hydraulic pump circuits can operate either separately or in unison, this optimises the energy management of the R 926.

Intelligent Operating Modes

- Sensitive Mode: for accurate lifting work
- Economy mode: for an economic and ecological operation. Recommended for normal working conditions
- Power Mode: for powerful excavation capacities in difficult applications
- Full Power Mode: especially designed for higher power, ideal for extreme applications

A D924 Liebherr Engine that is Even Cleaner and with Enhanced Performance

- New motor complies with the Tier 4 Final exhaust gas emission regulations thanks to its oxidation catalyst technology and SCR urea injection
- The most cutting-edge technology with the Common-Rail system without EGR valve and particle filter
- Automatic idling optimises energy efficiency

An Dozer and Stabilizer Blade

- Radial fan blade
- Different blade lengths available
- Exemplary dozing accuracy and quality
- Only two lubrication points
- Integral protection of cylinder rods as standard
- Fitted tie-down rings
- Enhanced stability ensures even greater productivity and safety



Efficiency



**High Level of Productivity for
a Lower Overall Operating Cost**

Multi-Purpose

The R 926 Compact is a multi-purpose machine that can be used for a great variety of purposes: its compact structure means it is perfect for worksites where space is restricted, such as town centres, roadworks or narrow forest tracks. What's more, it is capable of performing the traditional work of a standard crawler excavator, such as earth-moving, pipe-laying, demolition and material-handling works.

Compact Equipment

The kinematics of the attachments especially designed for the R 926 Compact allow for effective operations, even at heights, thanks to the boom joint being very close to the machine's centre of rotation. The total rotation radius can be equal to 1.90 m/6' 3".

Easy Access

All the maintenance points have been designed for easy access and to shorten intervention times. The gull-wing hood openings allow all operations to be performed from the ground. The operations can be carried out in complete safety, whether they concern the air filter, the fuel filters, the engine oil filter and the radiators or the checking of engine oil levels.

Intelligent Energy Management

The integrated engineering of Liebherr's systems allows constant monitoring of the fuel consumption and the urea solution thanks to the effective management of the engine and hydraulics. The new diesel engine, the new DOC/SCR exhaust after-treatment system, automatic idling/engine speed increase, electronic engine speed sensing regulation and Regeneration Plus are just some of the elements that contribute towards better energy management. This consumption control greatly reduces the discharge of toxic gases into the atmosphere while minimizing operating costs.

Automatic Centralised Lubrication System as Standard

- Fully automated centralised lubrication system as standard for rapid maintenance, less manual lubrication and shorter machine downtime
- Covers all the lubrication points of the uppercarriage and equipment, other than the connecting link (optional)
- Adequate lubrication of each joint guaranteed, for a longer service life of the moving parts
- Safety aspect: the lubrication can be performed without the operator having to leave the cab

LIKUFIX and Tool-Management

- Ideal for worksites requiring tool changes
- Mechanical and hydraulic coupling of tools possible without leaving the cab
- Optimised excavator operation with automatic tool change system
- Intelligent Tool-Management option, for automatic tool detection, pressure and corresponding flow adjustment

Liebherr Lubricants

- Complete range of lubricants and coolants for your Liebherr engines
- Special service with product specialists available to listen to and advise you



Reliability



**Result of Ongoing
improvements**

Accurately-Sized Mechanical Structures

The R 926 Compact is a very robust, powerful and reliable machine, ideal for all types of works, including difficult applications. The attachments are fitted with moulded steel parts, strategically positioned on the joints. Furthermore, thanks to the continuous optimisation and systematic numerical simulation of the structures, they can achieve the long service life our customers require.

Quality in the Minutest Details

The hydraulic, electric and lubrication lines are laid out to ensure optimum operating safety and the permanent uptime of the machine. The top-coat applied prior to assembly, as well as the surface treatment of the parts ensures a maximum protection against corrosion.

The Cab Operator's Protection

The cab is fitted with a roll-over protection system (ROPS), pursuant to ISO standard 12117-2. Invisible, it allows the operator to work in complete tranquility.

Automatic Operation Monitoring

The operator can concentrate fully on the task: the integrated on-board electronics ensure a constant readjustment to preset values. The operator can also access the operating parameters via the monitoring display.

A Robust Undercarriage

- X-shaped design for improved stress distribution and a longer service life
- Easy to maintain thanks to the wide openings under the track rollers and the fastening of the steps to the vertical side of the track carriers
- Varied range of optional features such as dozer and stabilizer blade, rubber track pads or a fitted tool box to adapt to all types of worksites

Liebherr Key Components

- A perfect harmonisation of the machine's elements for worksite applications
- The main mechanically-welded structures, (undercarriage, attachment and uppercarriage) designed by Liebherr
- Manufactured by Liebherr:
 - hydraulic pumps
 - pump reducer
 - translation mechanism
 - swing mechanism
 - swing ring
 - electronic components

Spare Parts Service

- The spare parts required are available from our logistics centre, for delivery around the world, thus guaranteeing optimal machine availability for assignment
- Over 100,000 different spare parts are available in stock

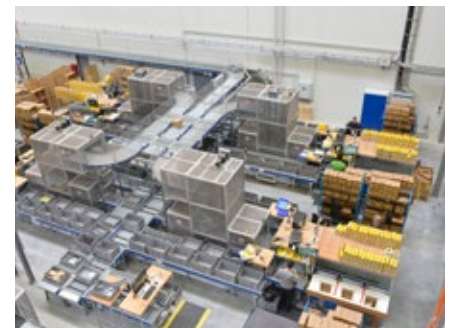
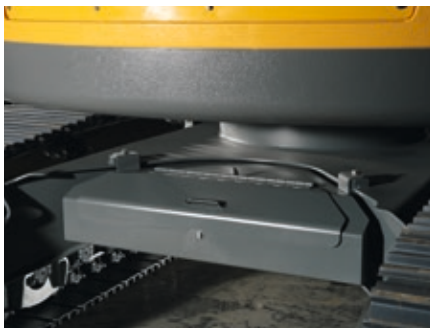

Comfort



**Spacious, Ergonomic
and with High-Visibility**

A First Class Work Space

In this new cab, the operator has a pneumatic seat with longitudinal and vertical pneumatic damping as standard, an enlarged space and a very comfortable work environment. Depending on the operator's needs, the Liebherr Premium seat can be chosen as an option. This seat offers maximum seating comfort thanks to its pneumatic lumbar support, its electronic weight-actuated height adjuster as well as its air-conditioning with activated charcoal and built-in fan.

Low Noise Level and Vibrations

To increase the operator's comfort and productivity, the noise level inside the operator's cab is exceptionally low. The cab is mounted on viscoelastic rivets to fully absorb vibrations. The rubber flanges that support the pipes also actively participate in reducing external noise.

7" Colour Touch Screen

A true control panel, this Liebherr designed and manufactured robust and reliable touch screen (ingress protection IP 65) offers numerous adjustment and monitoring options, such as the fuel consumption and urea solution delay, air-conditioning, tool control, radio, etc. And thanks to its high-resolution video compatibility, it can also display the images from the rear and side backup camera.

Large Storage Spaces

- Storage spaces behind the seat, with optional chiller for keeping drinks cool at all times
- Fully retractable windscreen, stowable under the roof
- 12 V plug for operating the optional chiller and all other types of appliances
- Optional foot-rest available for enhanced comfort especially when working on inclines

Ergonomic and Precise Joysticks

- Sensitive joysticks with proximity sensors allow greater responsiveness while resuming rpm and engine idling
- Ergonomical joysticks positioned for greater comfort during work and more accurate movement
- The proportional control allows a very fine manoeuvrability for a sensitive, accurate and more fluid operation of hydraulic tools

High Visibility

- Rear view and right hand side view monitoring camera seamlessly integrated for visibility and heightened operating safety
- Optimised design of the whole uppercarriage gives the operator a wider field of vision



Maintainability



**Simplified Daily Checks,
Longer Maintenance Intervals**

Simplified Daily Checks

The daily checks were taken into account from the start of the design, to make them simpler, more accessible and shorter. The fuel or diesel exhaust fluid levels, for example, can be checked via the display in the operator's cab. The fully-automatic central lubrication system can save precious intervention time, while guaranteeing that the excavator is in optimum operating condition and has a long life.

Less Maintenance for more Productivity

The frequency of the service intervals is optimised to guarantee that each part is functioning optimally and that the maintenance tasks are only performed as necessary. Whether it is the interval for changing the hydraulic oil, which can be up to 3,000 hours, or the interval for changing the engine oil, every 500 hours, everything has been taken into account to reduce the frequency of interventions and thus limit the machine's downtime and lower costs.

A Maintenance-Free Exhaust Gas Treatment

The exhaust gas treatment is carried out in compliance with the Tier 4 Final standards, without the use of a particle filter or EGR valve. This results in a maximum reliability in an output with no loss of productivity linked to the regeneration of this filter and, of course, there is no maintenance time or cost for spare parts associated with this technology.

Expert Advice and Service Provisions

Liebherr offers an expert advice service. Qualified personnel will help you make the appropriate decisions to meet your needs: sales arguments based on the terrain, service agreements, advantageous repair alternatives, original parts management, and remote data transfer for fleet management.

LiDAT Data Transfer System

- Complete fleet management, all from one source
- Optimized economical performance of the machine park thanks to detailed view of the distribution of operating states and times
- Reports on capacity commitment and the use of the machine park can be called up daily via the Web portal
- Precise location of the machine
- Regional delimitation and fixed downtimes increase safety and reliability

Hydraulic Reservoir Stop Valve

- Easy and quick isolation of the oil circuit between hydraulic reservoir and hydraulic system
- No drainage of fluid necessary for service or repair work on the hydraulic system

Central Lubrication System

- The fully-automatic central lubrication system, fitted as standard, allows for rapid maintenance: it saves time-consuming individual lubricating and downtime
- All the lubrication points on the superstructure of the undercarriage and the attachment hydraulics are supplied, with the exception of the connecting plate
- Engine oil level visible on display
- Coolant and swing gearbox oil levels visible from the operator seat



Experience the Progress

R 926 Compact

Equipment

- Large choice of sticks
- Longer lifespan of components and higher productivity thanks to automatic centralised lubrication system (option)
- Safety check valves for hoist and stick cylinders (option)

Comfort

- Spacious, air-conditioned work space
- Airsprung seat with vertical and longitudinal suspension
- Easy-to-use high resolution 7" colour touchscreen
- 3" orange seat belt
- New LED lighting as standard

Undercarriage

- Robust, reliable X-frame undercarriage, easy to secure thanks to its integrated eyelets
- Increased drawbar pull
- Maintenance-free travel gear and track rollers with lifetime lubrication for easy maintenance
- Extra storage (option)
- Dozer and stabilizer blade (option)





Safety

- Panoramic visibility with no obstructions and camera on the rear and the right side for enhanced safety (option)
- Tilttable console for easy and safe access to cab
- ROPS-certified cab structure
- Emergency exit via the rear cab window
- Right window and windshield in laminated and tinted glass

Engine

- New US EPA Tier 4 Final engine
- Automatic engine idling / speed increase, controlled via joystick sensors

Maintenance

- Servicing concept, with service points accessible from ground level
- Concept for lateral access to uppercarriage and large maintenance platform
- Engine oil, hydraulic oil, fuel and urea (diesel exhaust fluid) levels visible on the display

Technical Data



Engine

Rating	
per SAE J1349	173 HP (129 kW) at 1,900 rpm
per ISO 9249	175 HP (129 kW) at 1,900 rpm
Torque	682 Nm at 1,400 rpm / 503 lbf ft at 1,400 rpm
Model	Liebherr D924 A7-04
Type	4 cylinder in-line
Bore	104 mm / 4.1 in
Stroke	132 mm / 5.2 in
Displacement	4.5 l / 275 in³
Engine operation	4-stroke diesel Common-Rail Turbo-charged and after-cooler
Exhaust gas treatment	Tier 4 Final DOC + SCR Passive regeneration by thermo management
Cooling system	Water-cooled and integrated motor oil cooler
Air cleaner	Dry-type air cleaner with pre-cleaner, primary and safety elements
Fuel tank	331 l / 87 gal
Urea tank	45 l / 12 gal
Electrical system	
Voltage	24 V
Batteries	2 x 135 Ah / 12 V
Alternator	Three-phase current 28 V / 140 A
Engine idling	Sensor controlled



Hydraulic Controls

Power distribution	Via control valves with integrated safety valves, simultaneous and independent actuation of undercarriage, swing drive and equipment
Servo circuit	
Equipment and swing	Proportional via joystick levers
Travel	- Proportional control via foot pedals or removable levers - Speed pre-selection
Additional functions	Proportional regulation via foot pedals or mini-joystick



Hydraulic System

Hydraulic system	Positive Control hydraulic system. Demand-based, double independent pump flows Features high system dynamics and sensitivity provided by integrated system controlling
Hydraulic pump	For equipment and travel drive Liebherr, variable displacement, swashplate double pump
Max. flow	2 x 223 l/min. / 2 x 59 gpm
Max. pressure	350 bar / 5,076 psi
Pump management	Electronic pump management via the integrated system controlling (CAN-BUS) synchronous to the control block. Open circuit for the rotation
Hydraulic tank	153 l / 40 gal
Hydraulic system	max. 360 l / max. 95 gal
Hydraulic oil filter	1 main return filter with integrated partial micro filtration (10 µm / 1,250 mesh)
Cooling system	Compact cooler, consisting of a water cooler, with hydraulic oil cooler, gearbox oil cooler, fuel cooler and after-cooler cores and hydrostatically driven fan
MODE selection	Adjustment of engine and hydraulic performance via a mode pre-selector to match application, e.g. for especially economical and environmentally friendly operation or for maximum digging performance and heavy-duty jobs
Engine speed and performance setting	Stepless adjustment of engine output and hydraulic power via engine speed
Tool Control	20 pre-adjustable pump flows and pressures for add-on attachments



Swing Drive

Drive	Liebherr swashplate motor with integrated brake valve and torque control
Transmission	Liebherr compact planetary reduction gears
Swing ring	Liebherr, sealed race ball bearing swing ring, internal teeth
Swing speed	0 – 11.5 rpm stepless
Swing torque	84 kNm / 61,955 lbf ft
Holding brake	Wet multi-disc (spring applied, pressure released)
Lubrication	Liebherr central lubrication system



Operator's Cab

Cab	ROPS safety cab structure (roll-over protection system according to ISO 12117-2:2008) with windscreen, totally or partially retractable (only upper part), under cab roof, LED work headlights integrated in the ceiling, a door with a sliding window (can be opened on both sides), large stowing box and several stowing possibilities, shock-absorbing suspension, laminated right hand side and roof windows, all windows tinted, separate extensible window shades for the sunroof window and windscreen, cigarette lighter and 24 V plug, 12 V plug, cup holder
Operator's seat	Liebherr-Comfort seat, airsprung with automatic weight adjustment, vertical and longitudinal seat damping including consoles and joysticks. Seat and armrests adjustable separately and in combination (adjustable in width, height and inclination), seat heating as standard
Arm consoles	Oscillating consoles with seat, tiltable console left
Operation and displays	Large high-resolution operating unit, intuitive, color display with touchscreen, video-compatible, numerous setting, control and monitoring options, e.g. air conditioning control, fuel consumption, machine and attachment parameters
Air-conditioning	Automatic air-conditioning, recirculated air function, fast de-icing and demisting at the press of a button, air vents can be operated via a menu. Recirculated air and fresh air filters can be easily replaced and are accessible from the outside. Heating-cooling unit, designed for extreme outside temperatures, sensors for solar radiation, inside and outside temperatures
Noise emission	
ISO 6396	L_{pA} (inside cab) = 69 dB(A)
2000/14/EC	L_{WA} (surround noise) = 103 dB(A)



Undercarriage

LC	Gauge 2,390 mm / 7'10"
Drive	Liebherr swashplate motor with brake valves on both sides
Transmission	Liebherr compact planetary reduction gear
Maximum travel speed	Low range 3.2 km/h / 2.0 mph High range 5.1 km/h / 3.2 mph
Drawbar pull on crawler	236 kN / 53,055 lbf
Track components	B60, maintenance-free
Track rollers / Carrier rollers	9/2
Tracks	Sealed and greased
Track pads	Triple grouser
Holding brake	Wet multi-disc (spring applied, pressure released)
Brake valves	Integrated into travel motor
Lashing eyes	Integrated



Equipment

Hydraulic cylinders	Liebherr cylinders with seal and guidance systems
Bearings	Sealed, low maintenance
Lubrication	Liebherr central lubrication system

Dimensions

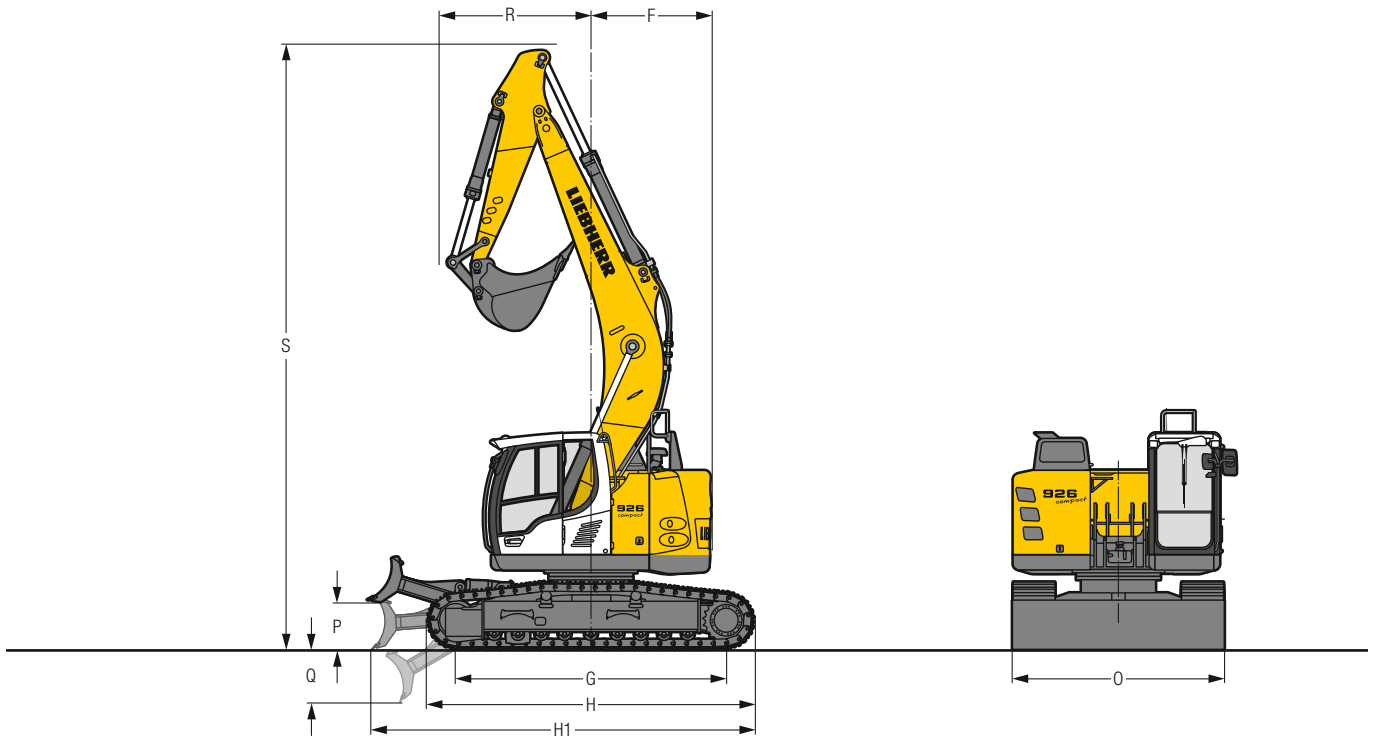
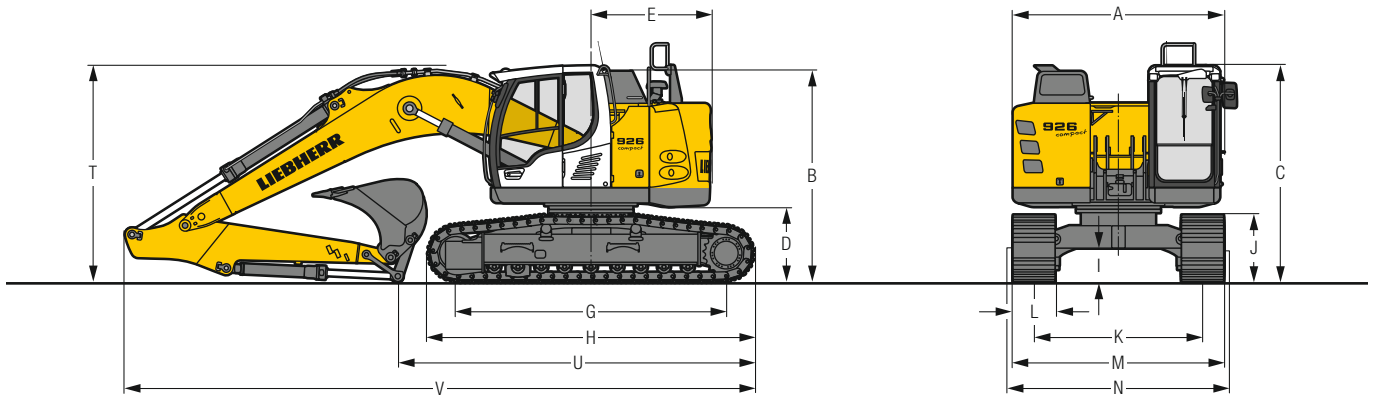

	LC	mm/ft in				LC with blade	mm/ft in			
A	Upper-carriage width	2,980 / 9' 9"				2,980 / 9' 9"				
B	Upper-carriage height	2,990 / 9'10"				2,990 / 9'10"				
C	Cab height	3,085 / 10' 1"				3,085 / 10' 1"				
D	Counterweight ground clearance	1,075 / 3' 6"				1,075 / 3' 6"				
E	Rear-end length	1,700 / 5' 7"				1,700 / 5' 7"				
F	Tail swing radius	1,700 / 5' 7"				1,700 / 5' 7"				
G	Wheelbase	3,830 / 12' 7"				3,830 / 12' 7"				
H	Undercarriage length	4,630 / 15' 2"				4,630 / 15' 2"				
H1	Undercarriage length with blade	-				5,425 / 17'10"				
I	Undercarriage ground clearance	450 / 1' 6"				450 / 1' 6"				
J	Track height	965 / 3' 2"				965 / 3' 2"				
K	Track gauge	2,390 / 7'10"				2,390 / 7'10"				
L	Track pad width	600 / 24"	700 / 28"	800 / 31"	900 / 35"	600 / 24"	700 / 28"	800 / 31"	900 / 35"	
M	Width over tracks	2,990 / 9'10"	3,090 / 10' 2"	3,190 / 10' 6"	3,290 / 10'10"	2,990 / 9'10"	3,090 / 10' 2"	3,190 / 10' 6"	3,290 / 10'10"	
N	Width over steps	2,925 / 9' 7"	3,125 / 10' 3**	3,125 / 10' 3**	3,225 / 10' 7**	2,925 / 9' 7"	3,125 / 10' 3**	3,125 / 10' 3**	3,225 / 10' 7**	
O	Blade width	-				-				
P	Max. blade height	-				675 / 2' 3"				
Q	Max. blade depth	-				750 / 2' 6"				

* width with removable steps

	Stick length m/ft in	Mono boom 5.70 m/18'8" direct mounting mm/ft in
R¹⁾	Front swing radius	2,35 / 7'9"
		2,65 / 8'8"
		2,95 / 9'8"
R²⁾	Front swing radius	2,35 / 7'9"
		2,65 / 8'8"
		2,95 / 9'8"
S	Height with boom up	8,550 / 28' 1"
T	Boom height	2,35 / 7'9"
		2,65 / 8'8"
		2,95 / 9'8"
U	Length on ground	2,35 / 7'9"
		2,65 / 8'8"
		2,95 / 9'8"
V	Overall length	2,35 / 7'9"
		2,65 / 8'8"
		2,95 / 9'8"
	Bucket	1.15 m ³ / 1.50 yd ³

¹⁾ without quick coupler with bucket

²⁾ with quick coupler and bucket

Transport Dimensions removable elements disassembled

	Stick m/ft in	Mono boom 5.70 m/18'8" mm/ft in			
Pad width		600 / 24"	700 / 28"	800 / 31"	900 / 35"
Transport width		2,990 / 9'10"	3,090 / 10' 2"	3,190 / 10' 6"	3,290 / 10'10"
Transport length	2.35 / 7'9"	9,050 / 29'8"			
	2.65 / 8'8"	9,050 / 29'8"			
	2.95 / 9'8"	9,050 / 29'8"			
Transport height	2.35 / 7'9"	3,085 / 10'1"			
	2.65 / 8'8"	3,085 / 10'1"			
	2.95 / 9'8"	3,085 / 10'1"			
	Bucket	1.15 m ³ / 1.50 yd ³			

Backhoe Bucket

with Mono Boom 5.70 m/18'8" and Counterweight 5.7 t/12,570 lb

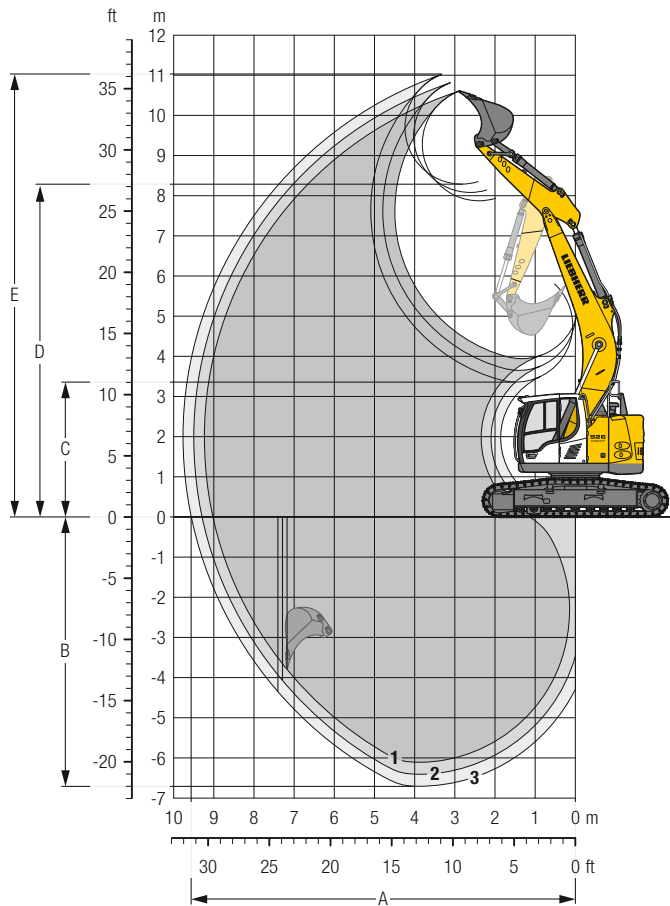

Digging Envelope

without quick coupler	1	2	3
Stick length	m/ft in 2.35/ 7' 9"	2.65/ 8'8"	2.95/ 9'8"
A Max. reach at ground level	m/ft in 9.02/29' 7"	9.29/30'6"	9.57/31'5"
B Max. digging depth	m/ft in 6.11/20' 1"	6.41/21'	6.71/22'
C Min. dumping height	m/ft in 3.94/12'11"	3.65/12'	3.36/11'
D Max. dumping height	m/ft in 7.87/25'10"	8.08/26'6"	8.29/27'2"
E Max. cutting height	m/ft in 10.59/34' 9"	10.81/35'6"	11.02/36'2"

Forces

without quick coupler	1	2	3
Stick digging force (ISO 6015)	kN/lbf 120/26,980	110/24,730	102/22,930
Bucket digging force (ISO 6015)	kN/lbf 140/31,470	140/31,470	140/31,470
Stick digging force (SAE J1179)	kN/lbf 113/25,400	105/23,610	97/21,810
Bucket digging force (SAE J1179)	kN/lbf 125/28,100	125/28,100	125/28,100

Operating Weight and Ground Pressure

The operating weight includes the basic machine with counterweight 5.7 t/12,570 lb, mono boom 5.70 m/18'8", stick 2.95 m/9'8" and bucket 1.15 m³/1.50 yd³ (755 kg/1,660 lb).

Undercarriage	LC			
Pad width	mm/in 600/24"	700/28"	800/31"	900/35"
Weight	kg/lb 25,300/55,780	25,550/56,330	25,850/56,990	26,150/57,650
Ground pressure	kg/cm ² /psi 0.51/7.3	0.44/6.3	0.39/5.5	0.35/5.0

Undercarriage	LC with blade			
Pad width	mm/in 600/24"	700/28"	800/31"	900/35"
Weight	kg/lb 27,250/60,080	27,500/60,630	27,800/61,290	28,100/61,950
Ground pressure	kg/cm ² /psi 0.55/7.8	0.48/6.8	0.42/6.0	0.38/5.4

Buckets Machine stability per ISO 10567* (75% of tipping capacity)

	Cutting width mm in	Capacity ISO 7451 m ³ yd ³	Weight ¹⁾ kg lb	Weight ⁴⁾ kg lb	LC-Undercarriage (with track pads 800 mm/31")						LC-Undercarriage with blade (with track pads 800 mm/31")					
					Stick length (m/ft in)						Stick length (m/ft in)					
					without quick coupler			with quick coupler			without quick coupler			with quick coupler		
					2.35 7'9"	2.65 8'8"	2.95 9'8"	2.35 7'9"	2.65 8'8"	2.95 9'8"	2.35 7'9"	2.65 8'8"	2.95 9'8"	2.35 7'9"	2.65 8'8"	2.95 9'8"
STD ¹⁾	650	0.55	480	515	▲	▲	▲	▲	▲	▲	▲	▲	▲	▲	▲	
	26"	0.72	1,060	1,140	▲	▲	▲	▲	▲	▲	▲	▲	▲	▲	▲	
	850	0.60	520	550	▲	▲	▲	▲	▲	▲	▲	▲	▲	▲	▲	
	34"	0.78	1,150	1,210	▲	▲	▲	▲	▲	▲	▲	▲	▲	▲	▲	
	1,050	0.80	600	635	▲	▲	▲	▲	▲	▲	▲	▲	▲	▲	▲	
	41"	1.05	1,320	1,400	▲	▲	▲	▲	▲	▲	▲	▲	▲	▲	▲	
	1,250	1.00	685	715	▲	▲	▲	▲	▲	▲	▲	▲	▲	▲	▲	
	49"	1.31	1,510	1,580	▲	▲	▲	▲	▲	▲	▲	▲	▲	▲	▲	
	1,400	1.15	755	785	▲	▲	▲	▲	▲	■	▲	▲	▲	▲	▲	
	55"	1.50	1,660	1,730	▲	▲	▲	▲	▲	■	▲	▲	▲	▲	▲	
HD ²⁾	1,250	1.25	890	925	▲	■	■	▲	■	▲	▲	▲	▲	▲	■	
	49"	1.63	1,960	2,040	▲	■	■	▲	■	▲	▲	▲	▲	▲	■	
	1,400	1.35	850	885	▲	■	▲	■	▲	■	▲	▲	▲	■	■	
	55"	1.77	1,870	1,950	▲	■	▲	■	▲	■	▲	▲	▲	■	■	
	1,400	1.50	950	980	▲	■	■	▲	■	▲	▲	▲	▲	▲	■	
	55"	1.96	2,090	2,160	▲	■	■	▲	■	▲	▲	▲	▲	▲	■	
	650	0.55	545	575	▲	▲	▲	▲	▲	▲	▲	▲	▲	▲	▲	
	26"	0.72	1,200	1,270	▲	▲	▲	▲	▲	▲	▲	▲	▲	▲	▲	
	850	0.60	585	615	▲	▲	▲	▲	▲	▲	▲	▲	▲	▲	▲	
	34"	0.78	1,290	1,360	▲	▲	▲	▲	▲	▲	▲	▲	▲	▲	▲	
1,050	0.80	675	705	▲	▲	▲	▲	▲	▲	▲	▲	▲	▲	▲		
41"	1.05	1,490	1,550	▲	▲	▲	▲	▲	▲	▲	▲	▲	▲	▲		
1,250	1.00	770	800	▲	▲	▲	▲	▲	▲	▲	▲	▲	▲	▲		
49"	1.31	1,700	1,760	▲	▲	▲	▲	▲	▲	▲	▲	▲	▲	▲		
1,400	1.15	850	880	▲	▲	▲	▲	▲	■	▲	▲	▲	▲	▲		
55"	1.50	1,870	1,940	▲	▲	▲	▲	▲	■	▲	▲	▲	▲	▲		
1,250	1.25	975	1,005	▲	■	■	■	■	▲	▲	▲	▲	▲	■		
49"	1.63	2,150	2,220	▲	■	■	■	■	▲	▲	▲	▲	▲	■		
1,400	1.35	935	965	■	■	▲	■	▲	■	▲	▲	▲	■	▲		
55"	1.77	2,060	2,130	▲	■	▲	■	▲	■	▲	▲	▲	■	▲		
1,400	1.50	1,090	1,120	▲	■	▲	■	▲	▲	▲	▲	▲	▲	■		
55"	1.96	2,400	2,470	▲	■	▲	■	▲	▲	▲	▲	▲	▲	■		

* Indicated loads are based on ISO 10567, at maximum reach, and may be swung 360° on firm and even ground

¹⁾ Standard bucket with teeth Uni 35-3

²⁾ HD bucket with teeth Uni 35-3

³⁾ Bucket for direct mounting

⁴⁾ Bucket for mounting to quick coupler

Other buckets available upon request

Max. material weight ▲ = ≤ 2.0 t/m³/3,400 lb/yd³, ■ = ≤ 1.8 t/m³/3,000 lb/yd³, ▲ = ≤ 1.65 t/m³/2,800 lb/yd³, ■ = ≤ 1.5 t/m³/2,500 lb/yd³, △ = ≤ 1.2 t/m³/2,000 lb/yd³

Lift Capacities



with Mono Boom 5.70 m, Counterweight 5.7 t/12,570 lb and Track Pads 800 mm/31"

Stick 2.35 m / 7'9"

Under-carriage	Height	3.0 m 10 ft		4.5 m 15 ft		6.0 m 20 ft		7.5 m 25 ft		m		
		t	lb	t	lb	t	lb	t	lb	ft	in	
LC	9.0 m 30 ft	7.4*	7.4*							7.0*	7.0*	3.2
	7.5 m 25 ft			6.8*	6.8*					5.7*	5.7*	5.4
	6.0 m 20 ft	8.6*	8.6*	7.2*	7.2*	5.0	6.4*			4.2	5.3*	6.7
	4.5 m 15 ft	12.2*	12.2*	7.5	8.4*	4.9	6.8*			3.5	5.4*	7.4
	3.0 m 10 ft			6.9	9.9*	4.6	7.5*	3.3	5.6	3.2	5.4	7.8
	1.5 m 5 ft			6.4	10.9*	4.4	7.7	3.2	5.5	3.0	5.2	7.8
	0 m 0 ft			6.2	10.8*	4.2	7.5	3.1	5.4	3.1	5.4	7.6
	-1.5 m -5 ft	11.4*	11.4*	6.2	9.9*	4.2	7.5			3.4	6.0	7.0
	-3.0 m -10 ft	10.2*	10.2*	6.3	8.1*	4.3	5.9*			4.3	5.9*	6.0
	-4.5 m -15 ft	5.8*	5.8*							4.6*	4.6*	4.3
LC Blade up	9.0 m 30 ft	7.4*	7.4*							7.0*	7.0*	3.2
	7.5 m 25 ft			6.8*	6.8*					5.7*	5.7*	5.4
	6.0 m 20 ft	8.6*	8.6*	7.2*	7.2*	5.4	6.4*			4.6	5.3*	6.7
	4.5 m 15 ft	12.2*	12.2*	8.1	8.4*	5.3	6.8*			3.8	5.4*	7.4
	3.0 m 10 ft			7.5	9.9*	5.0	7.5*	3.6	5.7	3.4	5.4	7.8
	1.5 m 5 ft			7.0	10.9*	4.8	7.8	3.5	5.6	3.3	5.2	7.8
	0 m 0 ft			6.8	10.8*	4.6	7.6	3.4	5.5	3.3	5.4	7.6
	-1.5 m -5 ft	11.4*	11.4*	6.8	9.9*	4.6	7.5*			3.8	6.0	7.0
	-3.0 m -10 ft	10.2*	10.2*	6.9	8.1*	4.7	5.9*			4.3	5.9*	6.0
	-4.5 m -15 ft	5.8*	5.8*							4.6*	4.6*	4.3
LC Blade down	9.0 m 30 ft	7.4*	7.4*							7.0*	7.0*	3.2
	7.5 m 25 ft			6.8*	6.8*					5.7*	5.7*	5.4
	6.0 m 20 ft	8.6*	8.6*	7.2*	7.2*	5.7	6.4*			4.8	5.3*	6.7
	4.5 m 15 ft	12.2*	12.2*	8.4*	8.4*	5.5	6.8*			4.0	5.4*	7.4
	3.0 m 10 ft			7.9	9.9*	5.3	7.5*	3.8	6.3*	3.6	5.7*	7.8
	1.5 m 5 ft			7.5	10.9*	5.0	8.0*	3.7	6.4*	3.5	6.1*	7.8
	0 m 0 ft			7.3	10.8*	4.9	8.0*	3.6	6.2*	3.6	6.2*	7.6
	-1.5 m -5 ft	11.4*	11.4*	7.2	9.9*	4.8	7.5*			4.0	6.1*	7.0
	-3.0 m -10 ft	10.2*	10.2*	7.4	8.1*	4.9	5.9*			4.9	5.9*	6.0
	-4.5 m -15 ft	5.8*	5.8*							4.6*	4.6*	4.3

Stick 2.65 m / 8'8"

Under-carriage	Height	3.0 m 10 ft		4.5 m 15 ft		6.0 m 20 ft		7.5 m 25 ft		m		
		t	lb	t	lb	t	lb	t	lb	ft	in	
LC	9.0 m 30 ft	7.2*	7.2*							5.9*	5.9*	3.8
	7.5 m 25 ft			6.4*	6.4*					4.9*	4.9*	5.8
	6.0 m 20 ft	7.3*	7.3*	6.8*	6.8*	5.1	6.1*			3.9	4.7*	7.0
	4.5 m 15 ft	11.2*	11.2*	7.6	8.0*	4.9	6.6*	3.4	5.6*	3.3	4.7*	7.7
	3.0 m 10 ft			7.0	9.6*	4.6	7.3*	3.3	5.7	3.0	4.9*	8.0
	1.5 m 5 ft			6.5	10.7*	4.4	7.7	3.2	5.5	2.9	4.9	8.1
	0 m 0 ft			6.2	10.9*	4.2	7.5	3.1	5.4	2.9	5.1	7.8
	-1.5 m -5 ft	10.8*	10.8*	6.2	10.1*	4.1	7.5			3.2	5.6	7.3
	-3.0 m -10 ft	11.1*	11.1*	6.3	8.5*	4.2	6.3*			3.9	5.8*	6.4
	-4.5 m -15 ft	7.0*	7.0*	5.4*	5.4*					5.0*	5.0*	4.8
LC Blade up	9.0 m 30 ft	7.2*	7.2*							5.9*	5.9*	3.8
	7.5 m 25 ft			6.4*	6.4*					4.9*	4.9*	5.8
	6.0 m 20 ft	7.3*	7.3*	6.8*	6.8*	5.5	6.1*			4.3	4.7*	7.0
	4.5 m 15 ft	11.2*	11.2*	8.0*	8.0*	5.3	6.6*	3.7	5.6*	3.6	4.7*	7.7
	3.0 m 10 ft			7.6	9.6*	5.0	7.3*	3.6	5.7	3.3	4.9*	8.0
	1.5 m 5 ft			7.1	10.7*	4.8	7.8	3.5	5.6	3.2	5.0	8.1
	0 m 0 ft			6.8	10.9*	4.6	7.6	3.4	5.5	3.2	5.1	7.8
	-1.5 m -5 ft	10.8*	10.8*	6.8	10.1*	4.5	7.5			3.5	5.7	7.3
	-3.0 m -10 ft	11.1*	11.1*	6.9	8.5*	4.6	6.3*			4.3	5.8*	6.4
	-4.5 m -15 ft	7.0*	7.0*	5.4*	5.4*					5.0*	5.0*	4.8
LC Blade down	9.0 m 30 ft	7.2*	7.2*							5.9*	5.9*	3.8
	7.5 m 25 ft			6.4*	6.4*					4.9*	4.9*	5.8
	6.0 m 20 ft	7.3*	7.3*	6.8*	6.8*	5.8	6.1*			4.5	4.7*	7.0
	4.5 m 15 ft	11.2*	11.2*	8.0*	8.0*	5.6	6.6*	3.9	5.6*	3.8	4.7*	7.7
	3.0 m 10 ft			8.0	9.6*	5.3	7.3*	3.8	6.1*	3.5	4.9*	8.0
	1.5 m 5 ft			7.5	10.7*	5.0	7.9*	3.7	6.3*	3.3	5.4*	8.1
	0 m 0 ft			7.3	10.9*	4.9	8.0*	3.6	6.3*	3.4	5.9*	7.8
	-1.5 m -5 ft	10.8*	10.8*	7.2	10.1*	4.8	7.6*			3.7	5.9*	7.3
	-3.0 m -10 ft	11.1*	11.1*	7.3	8.5*	4.9	6.3*			4.5	5.8*	6.4
	-4.5 m -15 ft	7.0*	7.0*	5.4*	5.4*					5.0*	5.0*	4.8

 Height
  Can be slewed through 360°
  In longitudinal position of undercarriage
  Max. reach
 * Limited by hydr. capacity

The load values are quoted in tons (t) / lb x 1,000 at stick end (without bucket), and may be swung 360° on firm and even ground. Adjacent values are valid for the undercarriage when in the longitudinal position. Capacities are valid for 800 mm/31" wide track pads. Indicated loads are based on ISO 10567 standard and do not exceed 75% of tipping or 87% of hydraulic capacity (indicated via *). Without bucket cylinder, link and lever the lift capacities will increase by 280 kg / 620 lb. Lifting capacity of the excavator is limited by machine stability and hydraulic capacity. Determine maximum load lift from load lift chart displayed in the operator's cab or from load lift chart detailed in the operator's manual supplied with the machine.

Stick 2.95 m / 9'8"

Under-carriage	3.0 m 10 ft	4.5 m 15 ft	6.0 m 20 ft	7.5 m 25 ft	m							
					ft	in						
LC	9.0 m t					5.0*	5.0*	4.3				
	30 ft lb					11,4*	11,4*	13'5"				
	7.5 m t		5.9*	5.9*	4.9*	4.9*	4.3*	4.3*	6.2			
	25 ft lb		13,1*	13,1*	11,0	12,8*	9,6*	9,6*	20'			
	6.0 m t		6.4*	6.4*	5.1	5.8*	3.7	4.1*	7.3			
	20 ft lb		13,9*	13,9*	11,0	12,8*	8,2	9,1*	23'8"			
	4.5 m t	10.3*	10.3*	7.6*	7.6*	4.9	6.4*	3.5	5.7*	3.1	4.1*	8.0
	15 ft lb	21,9*	21,9*	16,4*	16,4*	10,6	13,8*	7,4	11,8*	6,9	9,1*	26'
	3.0 m t			7.1	9.3*	4.7	7.1*	3.3	5.7	2.8	4.3*	8.3
	10 ft lb			15,3	20,0*	10,1	15,4*	7,2	12,2	6,3	9,5*	27'2"
	1.5 m t			6.5	10.5*	4.4	7.7*	3.2	5.5	2.7	4.7	8.3
	5 ft lb			14,1	22,8*	9,5	16,7	6,9	11,9	6,0	10,4	27'5"
	0 m t	6.2*	6.2*	6.2	10.9*	4.2	7.5	3.1	5.4	2.8	4.8	8.1
	0 ft lb	14,2*	14,2*	13,4	23,6*	9,0	16,2	6,7	11,6	6,1	10,6	26'8"
	-1.5 m t	10.3*	10.3*	6.1	10.3*	4.1	7.4	3.1	5.4	3.0	5.3	7.6
-5 ft lb	23,4*	23,4*	13,2	22,4*	8,9	16,0			6,7	11,6	24'11"	
-3.0 m t	12.0*	12.0*	6.2	8.9*	4.1	6.7*			3.6	5.7*	6.7	
-10 ft lb	25,9*	25,9*	13,4	19,3*	9,0	14,3*			8,0	12,5*	21'11"	
-4.5 m t	8.2*	8.2*	6.2*	6.2*					5.1*	5.1*	5.2	
-15 ft lb	17,3*	17,3*	13,0*	13,0*					11,2*	11,2*	16'10"	
LC Blade up	9.0 m t					5.0*	5.0*	4.3				
	30 ft lb					11,4*	11,4*	13'5"				
	7.5 m t		5.9*	5.9*	4.9*	4.9*	4.3*	4.3*	6.2			
	25 ft lb		13,1*	13,1*	11,9	12,8*	9,6*	9,6*	20'			
	6.0 m t		6.4*	6.4*	5.5	5.8*	4.0	4.1*	7.3			
	20 ft lb		13,9*	13,9*	11,9	12,8*	8,9	9,1*	23'8"			
	4.5 m t	10.3*	10.3*	7.6*	7.6*	5.3	6.4*	3.8	5.7*	3.4	4.1*	8.0
	15 ft lb	21,9*	21,9*	16,4*	16,4*	11,5	13,8*	8,1	11,8*	7,6	9,1*	26'
	3.0 m t			7.7	9.3*	5.1	7.1*	3.6	5.7	3.1	4.3*	8.3
	10 ft lb			16,6	20,0*	10,9	15,4*	7,8	12,3	6,9	9,5*	27'2"
	1.5 m t			7.1	10.5*	4.8	7.7*	3.5	5.6	3.0	4.7*	8.3
	5 ft lb			15,4	22,8*	10,3	16,8*	7,5	12,0	6,6	10,4*	27'5"
	0 m t	6.2*	6.2*	6.8	10.9*	4.6	7.6	3.4	5.4	3.0	4.9	8.1
	0 ft lb	14,2*	14,2*	14,7	23,6*	9,9	16,3	7,3	11,7	6,7	10,7	26'8"
	-1.5 m t	10.3*	10.3*	6.7	10.3*	4.5	7.5	3.4	5.4	3.3	5.3	7.6
-5 ft lb	23,4*	23,4*	14,5	22,4*	9,7	16,1			7,3	11,7	24'11"	
-3.0 m t	12.0*	12.0*	6.8	8.9*	4.5	6.7*			3.9	5.7*	6.7	
-10 ft lb	25,9*	25,9*	14,6	19,3*	9,8	14,3*			8,8	12,5*	21'11"	
-4.5 m t	8.2*	8.2*	6.2*	6.2*					5.1*	5.1*	5.2	
-15 ft lb	17,3*	17,3*	13,0*	13,0*					11,2*	11,2*	16'10"	
LC Blade down	9.0 m t					5.0*	5.0*	4.3				
	30 ft lb					11,4*	11,4*	13'5"				
	7.5 m t		5.9*	5.9*	4.9*	4.9*	4.3*	4.3*	6.2			
	25 ft lb		13,1*	13,1*	12,5	12,8*	9,6*	9,6*	20'			
	6.0 m t		6.4*	6.4*	5.8	5.8*	4.1*	4.1*	7.3			
	20 ft lb		13,9*	13,9*	12,5	12,8*	9,1*	9,1*	23'8"			
	4.5 m t	10.3*	10.3*	7.6*	7.6*	5.6	6.4*	4.0	5.7*	3.6	4.1*	8.0
	15 ft lb	21,9*	21,9*	16,4*	16,4*	12,1	13,8*	8,5	11,8*	8,0	9,1*	26'
	3.0 m t			8.1	9.3*	5.3	7.1*	3.8	6.0*	3.3	4.3*	8.3
	10 ft lb			17,5	20,0*	11,5	15,4*	8,3	13,0*	7,2	9,5*	27'2"
	1.5 m t			7.6	10.5*	5.1	7.7*	3.7	6.2*	3.2	4.7*	8.3
	5 ft lb			16,3	22,8*	10,9	16,8*	8,0	13,6*	7,0	10,4*	27'5"
	0 m t	6.2*	6.2*	7.3	10.9*	4.9	8.0*	3.6	6.3*	3.2	5.4*	8.1
	0 ft lb	14,2*	14,2*	15,6	23,6*	10,5	17,3*	7,8	13,6*	7,1	11,9*	26'8"
	-1.5 m t	10.3*	10.3*	7.2	10.3*	4.8	7.7*	3.6	5.9*	3.5	5.7*	7.6
-5 ft lb	23,4*	23,4*	15,4	22,4*	10,3	16,7*			7,7	12,7*	24'11"	
-3.0 m t	12.0*	12.0*	7.2	8.9*	4.8	6.7*			4.2	5.7*	6.7	
-10 ft lb	25,9*	25,9*	15,6	19,3*	10,4	14,3*			9,3	12,5*	21'11"	
-4.5 m t	8.2*	8.2*	6.2*	6.2*					5.1*	5.1*	5.2	
-15 ft lb	17,3*	17,3*	13,0*	13,0*					11,2*	11,2*	16'10"	

 Height
  Can be slewed through 360°
  In longitudinal position of undercarriage
  Max. reach
 * Limited by hydr. capacity

The load values are quoted in tons (t) **lb x 1,000** at stick end (without bucket), and may be swung 360° on firm and even ground. Adjacent values are valid for the undercarriage when in the longitudinal position. Capacities are valid for 800 mm / 31" wide track pads. Indicated loads are based on ISO 10567 standard and do not exceed 75% of tipping or 87% of hydraulic capacity (indicated via *). Without bucket cylinder, link and lever the lift capacities will increase by 280 kg / 620 lb. Lifting capacity of the excavator is limited by machine stability and hydraulic capacity.

Determine maximum load lift from load lift chart displayed in the operator's cab or from load lift chart detailed in the operator's manual supplied with the machine.

Available Attachments

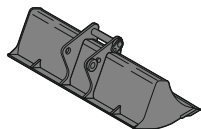

Rigid Ditch Cleaning Bucket

GRL 90, for direct mounting

Cutting width	mm/in	1,500/59"	2,000/79"	2,010/79"	2,400/95"				
Capacity	m ³ /yd ³	0.50/0.65	0.70/0.92	0.85/1.11	0.85/1.11				
Weight	kg/lb	400/880	500/1,100	530/1,170	580/1,280				

GRL 90, for mounting to quick coupler SWA 48

Cutting width	mm/in	1,500/59"	1,500/59"	2,000/79"	2,000/79"	2,000/79"	2,400/95"	2,400/95"	2,400/95"
Capacity	m ³ /yd ³	0.50/0.65	0.95/1.24	0.70/0.92	1.20/1.57	1.25/1.63	0.85/1.11	1.15/1.50	
Weight	kg/lb	430/950	560/1,240	400/880	640/1,410	600/1,320	600/1,320	650/1,430	

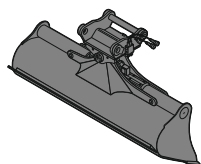

Tiltable Ditch Cleaning Bucket

GRL 90, 2 x 50° tiltable, for direct mounting

Cutting width	mm/in	1,600/63"	2,000/79"	2,000/79"	2,000/79"	2,200/87"	2,400/95"	2,800/110"		
Capacity	m ³ /yd ³	0.80/1.05	0.50/0.65	0.70/0.92	1.00/1.31	1.15/1.50	0.85/1.11	1.45/1.90		
Weight	kg/lb	798/1,760	686/1,510	819/1,810	883/1,950	920/2,030	885/1,950	1,009/2,220		

GRL 90, 2 x 50° tiltable, for mounting to quick coupler SWA 48

Cutting width	mm/in	1,600/63"	2,000/79"	2,000/79"	2,000/79"	2,200/87"	2,200/87"	2,200/87"	2,400/95"	2,400/95"	2,800/110"
Capacity	m ³ /yd ³	0.80/1.05	0.50/0.65	0.70/0.92	1.00/1.31	0.80/1.05	1.15/1.50	1.40/1.83	0.85/1.11	1.25/1.63	1.85/2.42
Weight	kg/lb	850/1,870	690/1,520	880/1,940	940/2,070	880/1,940	980/2,160	1,000/2,210	890/1,960	1,000/2,210	1,088/2,400

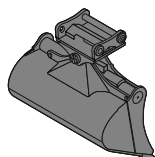

Tilt Bucket

SL 90, 2 x 50° tiltable, for direct mounting

Cutting width	mm/in	1,600/63"	1,600/63"	1,600/63"						
Capacity	m ³ /yd ³	0.80/1.05	1.00/1.31	1.35/1.77						
Weight	kg/lb	768/1,690	820/1,810	918/2,020						

SL 90, 2 x 50° tiltable, for mounting to quick coupler SWA 48

Cutting width	mm/in	1,500/59"	1,600/63"	1,600/63"	1,600/63"	1,600/63"	1,600/63"	1,600/63"	1,600/63"	1,600/63"
Capacity	m ³ /yd ³	1.20/1.57	0.80/1.05	1.00/1.31	1.35/1.77	1.55/2.03	0.80/1.05	1.00/1.31	1.35/1.77	1.55/2.03
Weight	kg/lb	970/2,140	820/1,810	890/1,960	970/2,140	1,035/2,280	820/1,810	1,006/2,220	1,184/2,610	1,550/3,420
HD-version							X	X	X	X

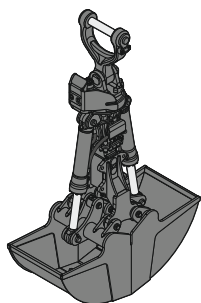

Clamshells

GMZ 24, earthmoving shell, for mounting to quick coupler SWA 48

Cutting width	mm/in	600/24"		800/31"			1,000/39"		
Capacity	m ³ /yd ³	0.34/0.44		0.46/0.60			0.60/0.78		
Weight	kg/lb	890/1,960		970/2,140			1,040/2,290		

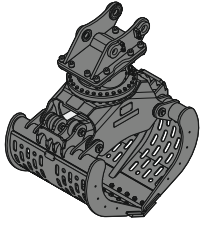

Sorting Grab

		ribbed		perforated		stone tong
SG 30, for direct mounting						
Cutting width	mm / in	800 / 31"	1,000 / 39"	800 / 31"	1,000 / 39"	800 / 31"
Capacity	m ³ / yd ³	0.50 / 0.65	0.65 / 0.85	0.55 / 0.72	0.75 / 0.98	0.55 / 0.72
Weight	kg / lb	1,100 / 2,430	1,180 / 2,600	1,050 / 2,320	1,100 / 2,430	1,240 / 2,730

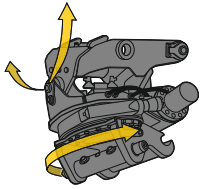

Tiltrotator

LH-TR 25, for mounting to quick coupler SWA 48		
Weight	kg / lb	720 / 1,590
Rotation		360°
Tilt		2 x 50°

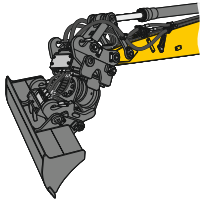

LiTiU

2 x 45° R, for mounting to quick coupler SWA 48		
Weight	kg / lb	740 / 1,630

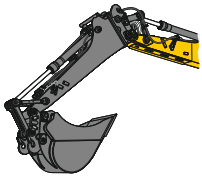

Stick Extension

LS 12, for mounting to quick coupler SWA 48		
Length	m / ft in	2.25 / 7'5"
LS 18, for mounting to quick coupler SWA 48		
Length	m / ft in	2.65 / 8'8"

Serial Equipment

Undercarriage

- Lashing eyes
- Sprocket with dirt ejector
- Track and carrier rollers, sealed and lifetime-lubricated

Uppercarriage

- Anti-skid surfaces
- Automatic swing brake lock
- Centralized lubrication system (automatic)
- Engine coolant level, visible from the cab
- Engine hood with gas spring opening
- Filters accessible from ground level
- Handrails
- Hydraulic oil level, visible from ground level
- Lockable fuel tank cap
- Lockable service doors
- Main switch, manual, lockable
- Protection grid on radiator fan
- Sound insulation
- Swing drive gearbox oil level, visible from the cab
- Swing-out radiators
- Windshield washer fluid tank

Hydraulic System

- Filter with integrated fine filters
- Hydraulic pressure measuring ports
- Hydraulic tank shut-off valve
- Liebherr Positive Control system with 2 independent circuits
- Magnetic rod
- Pressure accumulator for controlled lowering of equipment with engine turned off

Engine

- Air filter with automatic dust ejector
- Automatic engine idling / speed increase, controlled via joystick sensors
- Common-Rail injection system
- Exhaust gas after-treatment system – DOC + SCR
- Fixed geometry turbocharger
- Fuel fine filter
- Fuel pre-filter and water separator
- Fuel priming pump
- Intercooler
- Power Pack US EPA Tier 4 Final
- Stepless adjustable engine speed

Operator's Cab

- 7" multifunction color touchscreen
- Air conditioning, automatic, tri-zone, controlled via display
- Armrests adjustable in width, height and inclination
- Bottle holder
- Cab air filters housing, accessible from ground level
- Cab door sliding windows
- Cigarette lighter
- Coat hook
- DEF consumption on touchscreen
- DEF level on touchscreen
- Electric socket in cabin (12 V)
- Electric socket in cabin (24 V)
- Emergency hammer
- Engine oil level on touchscreen
- Fuel consumption on touchscreen
- Fuel level on touchscreen
- Hydraulic oil level on touchscreen
- Impact resistant roof window
- Interior lighting
- Laminated right hand side window
- LIDAT Plus (Liebherr data transfer system)*
- Mechanical hour meters, visible from ground level
- Movement priority between swing and boom, adjustable via touchscreen
- Movement priority for stick-in, adjustable via touchscreen
- Rain hood over front window opening
- Rearview mirror
- Rear view monitoring camera
- Rear window emergency exit
- Roll-down sun blinds for windscreen and roof window
- ROPS safety cab structure (ISO 12117-2)
- Rubber floor mat, fixed on floor and removable
- Shortcut button on joystick configurable
- Storage nets
- Storage spaces
- Tilttable console left
- Tinted windows
- Visco-elastic damping
- Windscreen wiper and washer
- Work mode selector

Equipment

- Boom cylinders regeneration
- Pivot points made of cast steel
- SAE split flanges on high pressure lines
- Stick cylinder regeneration

* optionally extendable after one year

Equipment Standard/Option

Undercarriage

Chain guide 1 piece	•
Chain guide 3 pieces	+
Cover and base plate for undercarriage center section	•
Dozer and stabilizer blade 3,000 mm / 9'10"	+
Dozer and stabilizer blade 3,100 mm / 10'2"	+
Reinforced cover and base plate for undercarriage center section	+
Rubber track pads	+
Special painting	+
Steps	•
Steps wide	+
Track pads triple grouser 600 mm / 24" / 700 mm / 28" / 900 mm / 35"	+
Track pads triple grouser 800 mm / 31"	•
Track pads triple grouser reinforced 600 mm / 24" / 700 mm / 28"	+
Tracks, sealed and greased	•
Tracks, sealed and greased, reinforced	+
Undercarriage LC	•
Undercarriage storage compartment	+

Uppercarriage

Air pre-filter with cyclonical dust trap	+
Catwalk tiltable front left	+
Counterweight standard 5.7 t / 12,570 lb	•
Electric socket on uppercarriage (24 V)	+
Extended tool set including tool box	+
Fuel anti-theft protection	+
Headlight on uppercarriage, front left, LED+, 1 piece, protection included	+1)
Headlight on uppercarriage, front right, LED+, 1 piece, protection included	+1)
Headlight on uppercarriage, lateral right, LED+, 1 piece	+1)
Headlights on uppercarriage, rear, LED+, 2 pieces	+1)
Lighting for tank area	+1)
Lighting for uppercarriage access	+1)
Pre-heating system for fuel	+
Radiator fine mesh protection grid	+
Reflective warning stickers	+
Reversible fan drive	+
Rotating beacons on uppercarriage, rear, LED, 2 pieces	+
Special painting	+
Skyview 360°	+
Tank refilling pump fuel	+
Tool set including storage case	•
Uppercarriage bottom protection	+



Hydraulic System

Bypass filter for hydraulic oil	+
Liebherr hydraulic oil	•
Liebherr hydraulic oil, adapted for extreme climate conditions	+
Liebherr hydraulic oil, biodegradable	+



Engine

Automatic engine shutdown after idling	+
Engine shut-down with overrun	+
Lighting for engine compartment	+1)

Equipment Standard/Option



Operator's Cab

3" seat belt with retractor, orange color	•
4-points seat belt	+
Acoustic travel alarm deactivatable	+
Auxiliary heater programmable	+
Bottom windscreen wiper	+
Coming /Leaving Home	+ ¹⁾
Cool box (12 V)	+
Dark tinted windows	+
Electronic immobilizer	+
Emergency stop in cab	+
FGPS front guard	+
FGPS front guard tiltable	+
Filter for hydraulic hammer return flow	+
Fire extinguisher	+
First-aid box	+
Footrest	+
FOPS top guard	+
Handrests elevated for joysticks	+
Headlights on cab, front, LED, 2 pieces	• ¹⁾
Headlights on cab, front, LED+, 2 pieces	+ ¹⁾
Headlights on cab roof, front, LED+, 2 pieces	+ ¹⁾
High pressure circuit switchable on pedals or mini-joystick	+
High pressure circuit with Tool Control (20 attachment adjustments on display)	+
Impact resistant one-piece windscreen	+
Lightbar on cabin	+
Lighting for cabin access	+ ¹⁾
Luminosity control (LED+ headlights)	+ ¹⁾
Medium pressure circuit	+
Mini-joysticks proportional	•
Movement restriction for boom	+
Movement restriction for stick	+
Operator seat Comfort	•
Operator seat Premium	+
Overload warning system	+
Preparation for machine guidance system	+
Preparation for tiltrotator	+
Radio Comfort	+
Radio pre-installation	•
Retractable laminated two-piece windscreen	•
Right hand side view monitoring camera	•
Roof sun shield	+
Roof window wiper	+
Rotating beacon on cabin, LED, 1 piece	+
Seat belt reminder	+
Special painting	+
Sun visor	+
Switch between high pressure and bucket cylinder controls	+
Windscreen bottom protection grid	+

• = Standard, + = Option

¹⁾ Equipment not individually available, but only as predefined lighting packages
Non-exhaustive list, please contact us for further information.

Options and/or special equipments, supplied by vendors other than Liebherr, are only to be installed with the knowledge and approval of Liebherr in order to retain warranty.



Equipment

Adjustable boom cylinder rod protection	+
Bucket cylinder rod protection	+
Centralized lubrication extended for connecting link	+
Grapple hydraulic lines (bucket cylinder inactive)	+
Headlight guard on boom, right	+
Headlight guards on boom, right and left	+
Headlight on boom, left, LED+, 1 piece	+ ¹⁾
Headlight on boom, right, LED, 1 piece	• ¹⁾
Headlight on boom, right, LED+, 1 piece	+ ¹⁾
Headlight on stick, bottom, LED+, 1 piece	+ ¹⁾
Leak oil line for attachment	+
Lifting eye on stick 16.0 t / 35,270 lb	+
LIKUFIX electric signal plug	+
LIKUFIX for quick coupler SWA 48 hydraulic	+
Load holding valve for bucket cylinder	+
Lubrication hoses protection on stick	+
Mono boom 5.70 m / 18'8"	•
Pipe fracture safety valve for stick cylinder	+
Pipe fracture safety valves for boom cylinders	+
Quick coupler SWA 48 hydraulic	+
Quick coupler SWA 48 mechanical	+
Security for hoist cylinders	+
Special painting	+
Stick 2.35 m / 7'9"	+
Stick 2.65 m / 8'8"	+
Stick 2.95 m / 9'8"	+
Stick bottom protection	+
Tool Management	+

WARNING

This product can expose you to chemicals including lead and lead compounds, which are known to the State of California to cause cancer and birth defects or other reproductive harm.
For more information go to www.P65warnings.ca.gov.

WARNING

Breathing diesel engine exhaust exposes you to chemicals known to the State of California to cause cancer and birth defects or other reproductive harm.
▶ Always start and operate the engine in a well-ventilated area.
▶ If in an enclosed area, vent the exhaust to the outside.
▶ Do not modify or tamper with exhaust system.
▶ Do not idle the engine except as necessary.
For more information go to www.P65warnings.ca.gov/diesel.