

LIEBHERR

Use and Care Manual

For Fully Integrated NoFrost
Combined Refrigerator-Freezers

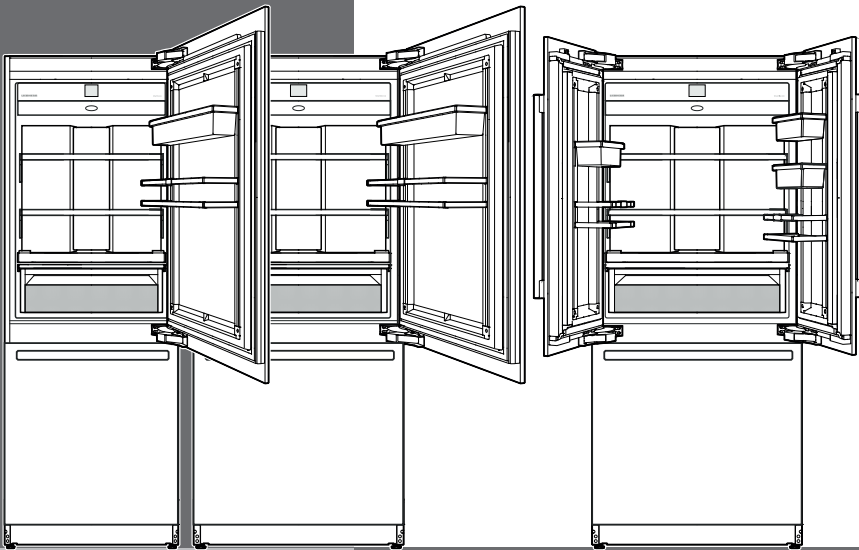

MCB 3050 / MCB 3060
MCB 3650 / MCB 3652 / MCB 3660 / MCB 3661 / MCB 3662
7080 402-01

TABLE OF CONTENTS

Table of Contents	Page
Please Read and Follow these Instructions	2
California Proposition 65.....	3
Disposal of Old Appliance	3
Disposal of this Appliance	3
Disposal of Packaging Material	3
Symbols on the device:.....	3
Important Safety Information	4
R600a Refrigerant.....	5
Electrical Safety	6
Safety Regulations.....	6
Description of the Appliance.....	7
Control Panel	8
Fast access to information.....	8
Switching the Appliance On.....	8
Main Menu	9
Setting the Temperature	10
Setting the Temperature (Refrigerator Compartment).....	10
Setting the Temperature (Freezer Compartment)	11
Setting the Temperature (BioFresh-Plus Compartment).....	11
SuperCool	12
SuperFrost	13
Freezing and Storage.....	13
Safety Instructions and Warnings for the Ice Maker	14
Ice Maker Description	14
Switching the IceMaker on.....	14
Switching the Ice Maker Off.....	15
Switching the IceMaker to Maximum Ice Production ...	15
PartyMode.....	16
HolidayMode.....	16
SabbathMode	17
Switching the Appliance Off	17
Maintenance Message	18
Maintenance Confirmation.....	18
Setup Menu.....	19
SmartDeviceBox (Not Supplied in All Countries)	21
Description of the SmartDevice Displays	22
Alarm Messages	22
Equipment	25
Water Dispenser	26
BioFresh-Plus Compartment	26
Cleaning	27
Maintenance Menu	28
Maintenance	29
Additional Functions	33
Troubleshooting	39
Customer Service	39
Appliance Information	39

Please Read and Follow these Instructions

These instructions contain Danger, Warning, and Caution notes.

This information is important for safe and efficient installation and operation.

Always read and comply with all Danger, Warning, and Caution notes!



Danger indicates a hazard which will cause serious injury or death if precautions are not followed.



Warning indicates a potentially hazardous situation which, if not avoided, could result in death or serious injury.



Caution indicates a potentially hazardous situation which, if not avoided, may result in minor or moderate injury.

IMPORTANT

This indicates information that is especially relevant to a problem-free installation and operation.

IMPORTANT

All types and models are subject to continuous improvement. The manufacturer reserves the right to make modifications to the shape, equipment, and technology.

California Proposition 65

- This product contains chemicals known to the state of California to cause cancer or reproductive harm.
- This product can expose you to chemicals including Diisononyl Phthalate (DINP) which is known to the State of California to cause cancer. For more information go to www.P65Warnings.ca.gov.
- This product can expose you to chemicals including Diisodecyl Phthalate (DIDP) which is known to the State of California to cause birth defects or other reproductive harm. For more information go to www.P65Warnings.ca.gov.

Disposal of Old Appliance



DANGER!

Risk of child entrapment.

Child entrapment and suffocation are not problems of the past.

Junked or abandoned refrigerators are still dangerous – even if they will sit for “just a few days.”

If you are getting rid of your old refrigerator, please follow these instructions to help prevent accidents.

Before you discard old appliances:

- **Take off the doors.**
- **Leave the shelves in place so that children may not easily climb inside.**
- **Cut off the power cord from the discarded appliance. Discard separately from the appliance.**
- **Be sure to follow your local requirements for disposal of appliances.**

Contact the trash collection agency in your area for additional information.

Disposal of this Appliance

This appliance contains flammable gases within the refrigeration circuit and insulation foam.

Contact the municipality or disposal company in your area for information on approved recycling or disposal.

Disposal of Packaging Material

The packaging is designed to protect the appliance and individual components during transport and is made of recyclable materials.



WARNING!

Keep packaging materials away from children. Polythene sheets and bags can cause suffocation!

If possible, please recycle packaging material at a recycling facility.

Symbols on the device:

	<p>The symbol can be on the compressor. It refers to the oil in the compressor and refers to the following danger: Can be lethal if swallowed or inhaled. This notice only applies for recycling. There is no danger during normal operation.</p>
	<p>The symbol is located on the compressor and indicates the danger of flammable materials. Do not remove the label.</p>
	<p>This label or a similar one may be located on the rear of the appliance. This label indicates that there are vacuum insulation panels (VIP) or perlite panels in the door and/or housing. This notice only applies for recycling. Do not remove the label.</p>

Important Safety Information

- **WARNING:** Keep ventilation openings, in the appliance enclosure or in the built-in structure, clear of obstruction.
- **WARNING:** Do not use mechanical devices or other means to accelerate the defrosting process, other than those recommended by the manufacturer.
- **WARNING:** Do not damage the refrigerant circuit.
- **WARNING:** The power cord must not be damaged while installing the appliance.
- **WARNING:** Multi-sockets or distributor strips and other electronic devices (such as halogen transformers) must not be positioned and operated at the rear of appliances.
- **WARNING:** Danger of injury through electric shock! There are live parts under the cover. Only have the interior LED light replaced or repaired by customer service staff or trained personnel.
- **WARNING:** Risk of injury from the LED lamp. The light intensity of the LED light complies with risk group RG 2. If the cover is defective, do not look directly at the light through optical lenses from close distance. This may damage your eyes.
- **WARNING:** This appliance must be secured as described in the Use and Care Manual (Installation Instructions) to rule out any potential risks due to its instability.
- **WARNING:** Do not use electrical appliances inside the food storage compartments of the appliance, unless they are of the type recommended by the manufacturer.
- Any repairs and work on the appliance should only be performed by the customer service department. Unauthorized work may be dangerous to the user. The power source cable should only be changed or replaced by the customer service department. Component parts and power cords shall be replaced with like components performed by factory authorized service personnel only.
- Do not stand on the toe kick, drawers or doors or use them to support anything else.
- This appliance is not intended for use by persons (including children) with reduced physical, sensory or mental capabilities or lack of experience and knowledge unless they have been given initial supervision or instruction concerning use of the appliance by a person responsible for their safety. Children should be supervised to ensure that they do not play with the appliance.
- Do not store explosive substances such as aerosol cans with a flammable propellant in this appliance.
- To prevent injury and damage to property, the appliance should only be installed by four people.
- Check the appliance for signs of damage after unpacking. Contact the supplier if it is damaged. Do not connect the appliance to the mains power supply.
- Avoid prolonged skin contact with cold surfaces (e.g., chilled/frozen products). If necessary, take safety action (e.g., gloves).
- Do not consume food which has been stored for too long; it could cause food poisoning.

R600a Refrigerant

- Any repairs and work on the appliance should only be performed by the customer service department or other trained personnel. The same applies to changing the power cord.
- Only perform repair and other work on the appliance when the plug has visibly been disconnected.
- Only install, connect, and dispose of the appliance as described in this Use and Care Manual.
- In the event of a fault, pull out the plug or switch off the fuse.
- When disconnecting the appliance from the power source, pull it out by the plug, never pull on the cable.
- If you have a lockable appliance, do not keep the key near the appliance or within reach of children.
- The appliance is designed for use in enclosed rooms. Do not operate the appliance outdoors or in areas where there is moisture or splashing water.
- Do not use the interior LED light to light the room. The interior LED light is only designed to illuminate the interior of the appliance.
- Do not allow naked flames or ignition sources to enter the appliance.
- Alcoholic drinks or other vessels containing alcohol should be sealed tightly for storage.



WARNING

The refrigerant R600a contained within the appliance is environmentally friendly, but flammable. Leaking refrigerant can ignite.

Electrical Safety

Connect this appliance to a 15 amp or 20 amp, 110-120 VAC, circuit which is grounded and protected by a circuit breaker or fuse.

We recommend using a dedicated circuit for this appliance to prevent circuit overload and the chance of interruption to the appliance.

This appliance is equipped with a three-prong (grounding) polarized plug for your protection against possible shock hazards.

Where a two-prong wall receptacle is encountered, contact a qualified electrician and have it replaced with a properly grounded three-prong receptacle in accordance with all local codes and ordinances.



WARNING!

Electrocution hazard.

Electrical grounding required.

- Do not remove the round grounding prong from the plug. →
- Do not use extension cords or ungrounded (two prong) adapters.
- Do not use a power cord that is frayed or damaged.



- Do not use a power strip. →

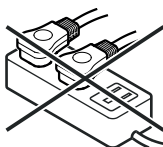

Failure to follow these instructions may result in fire, electrical shock or death.

Safety Regulations

This appliance is intended to be used in household and similar applications.

This includes, for example, use

- in staff kitchenettes, bed and breakfast establishments,
- by guests in cottages, hotels, motels and other forms of accommodation,
- in catering and similar services in the wholesale trade.

IMPORTANT

The appliance is not intended for outdoor use.

The appliance is manufactured to operate within specific ambient temperature limits according to its climate rating.

The climate rating indicates the ambient temperature at which the appliance may be operated in order to achieve full refrigeration performance.

Climate Rating	Ambient Temperature
SN-T	50°F to 109°F (10°C to 43°C)

IMPORTANT

Do not operate the appliance outside the specified ambient temperature range.

- The refrigerant circuit has been tested for leaks.
- The appliance complies with current safety regulations

CAN/CSA C22.2 No. 60335-2-24 / UL 60335-2-24
CAN/CSA C22.2 No. 60335-1 / UL 60335-1

We recommend cleaning the appliance before turning it on for the first time. See „Cleaning“.

Turn on the appliance several hours before loading it.



WARNING!

Do not allow children to play with the appliance. Children must not climb, sit or stand on the shelves or door.

Failure to follow these instructions may result in death or serious injury.

Description of the Appliance

MCB 30..

MCB 36..

MCB 36.2

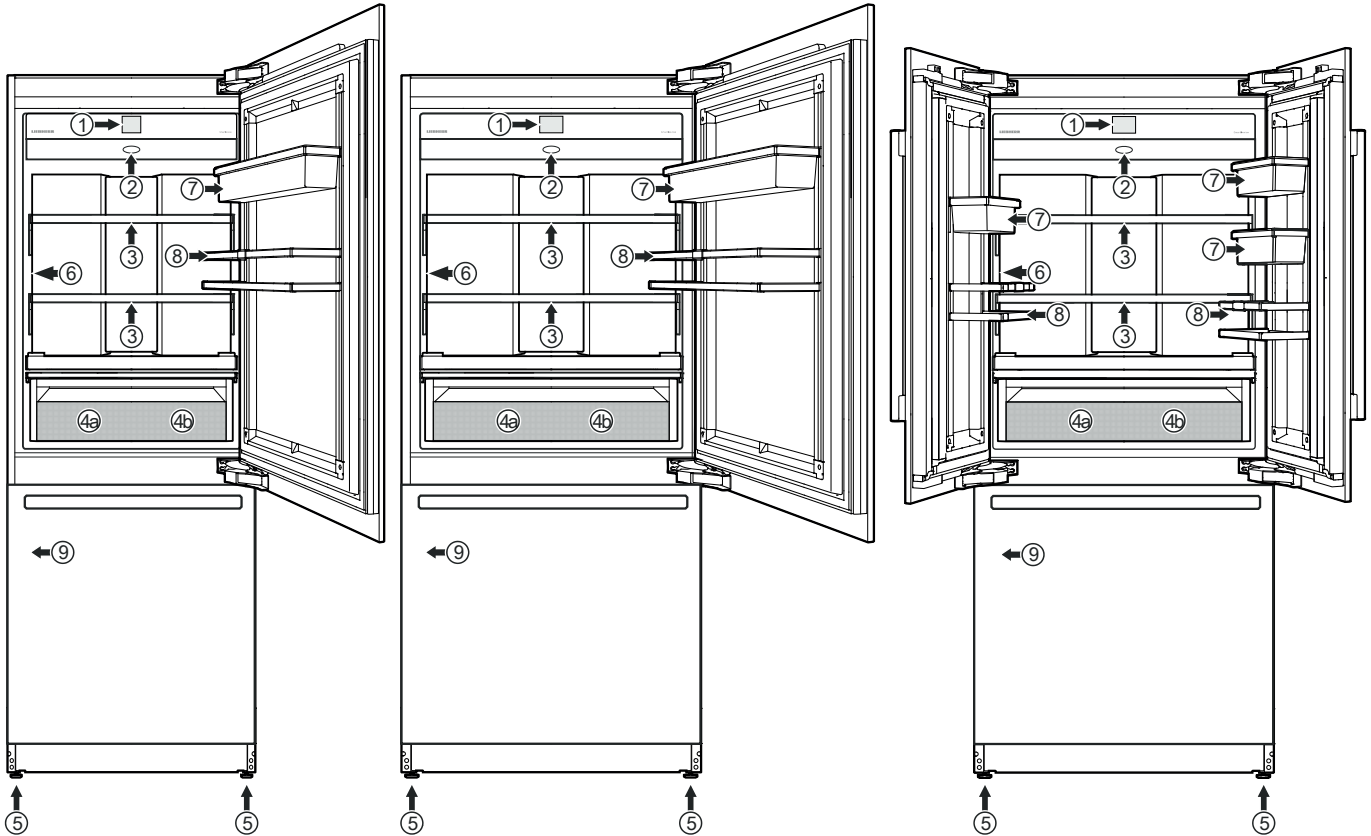

- (1) Control panel
- (2) Air filter
- (3) Adjustable shelves (max. 44 lbs (20 kg))
- (4a/b) BioFresh-Plus drawer. For storing food at a temperature of either 32°F or 28°F.
- (5) Adjustable-height feet
- (6) Water dispenser
- (7) Adjustable door rack
- (8) Gallon rack *
- (9) Model plate (behind the drawer on the left-hand side)
- (10) Water filter (behind the ventilation grille)
- (11) Ice maker (inside the drawer) and removable ice cube bin
- (12) Freezer drawer

<ul style="list-style-type: none"> MCB 30.. (max. 55 lbs (25 kg)) MCB 36.. (max. 66 lbs (30 kg)) MCB 36.2 (max. 33+33 lbs (15+15 kg)) 	}
--	---

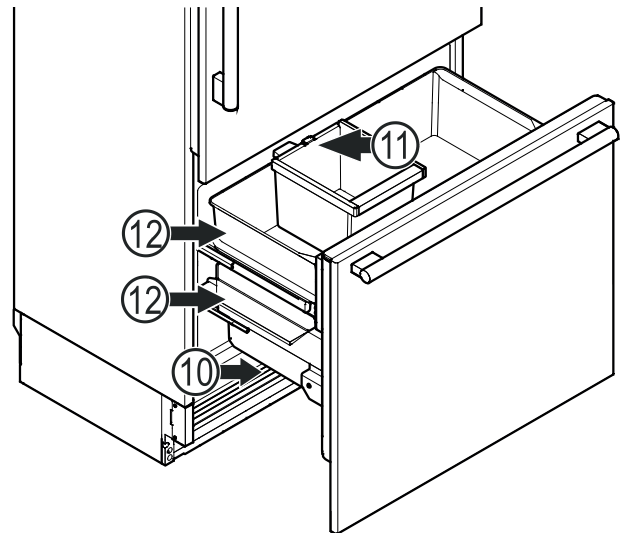

* Depending on model and options

Control Panel

Three different actions to operate the control panel.

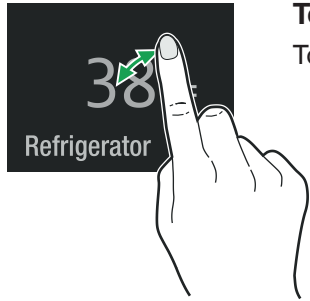

Touch

Touch to activate functions.

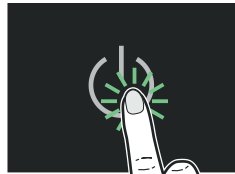

Press

Press for approx. 2 seconds to activate functions.

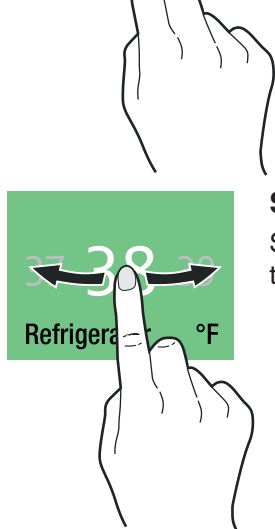

Slide

Slide to right or left to navigate in the menu or to search for values.

Fast access to information

(models MCB ...6. only)

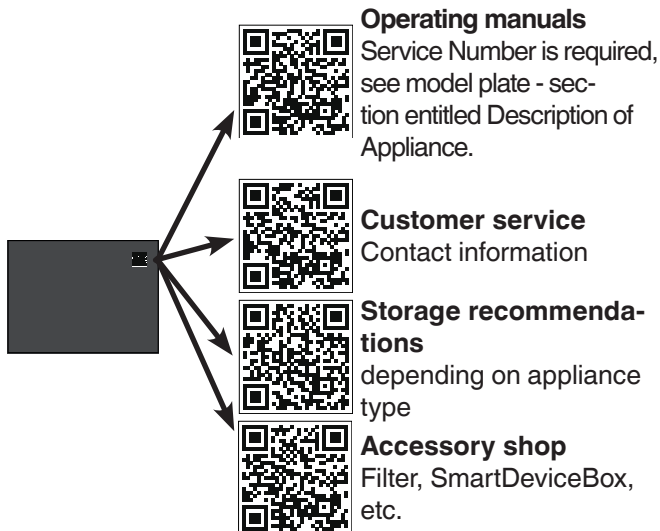

Switching the Appliance On

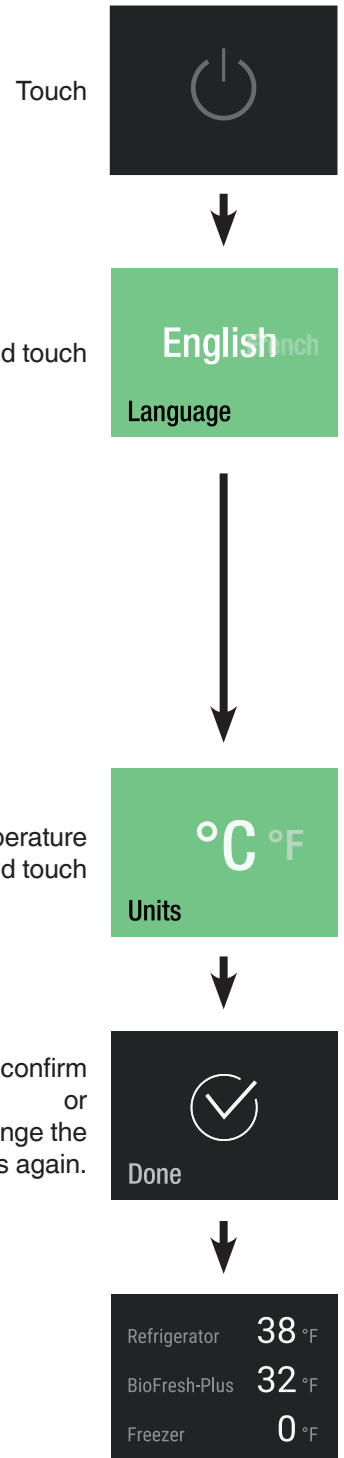

Main Menu

Slide through the main menu. The following functions are available.



Refrigerator compartment temperature display and temperature setting.

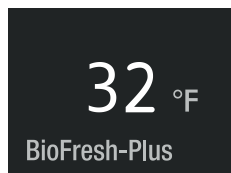

BioFresh-Plus compartment temperature display and temperature setting.

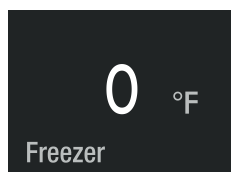

Freezer compartment temperature display and temperature setting.

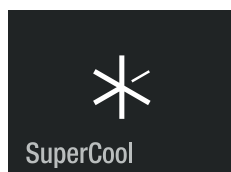

For maximum cooling with time limit and automatic return to normal operating mode.

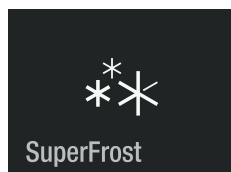

To freeze fresh food as rapidly as possible to ensure that the nutritional value, appearance and flavor of the food remains intact.

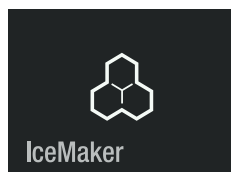

To switch the IceMaker on or off and to maximum ice production.

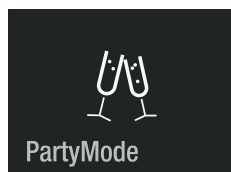

For permanent maximum cooling.

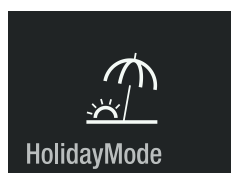

Switches the appliance to an energy-saving operating mode; the temperature in the refrigerator compartment is increased to 59°F.

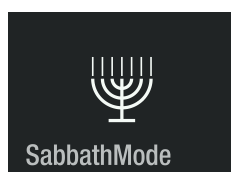

Appliance operating mode for Sabbath and holidays. Complies with STAR-K Kosher Certification.

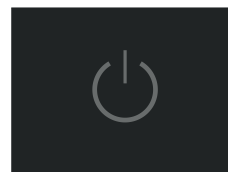

Switching the appliance on or off.

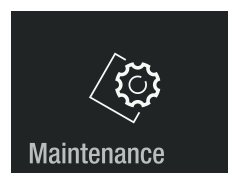

Describes how to change the filters and clean the water dispenser and dust filter.

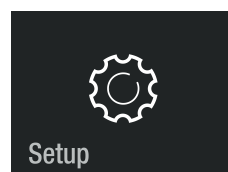

Allows the adjustment of display brightness and includes the appliance information (service number, model name, serial number).

IMPORTANT

The temperature in the appliance's compartments may rise significantly if the door is left open for a lengthy period.

Setting the Temperature

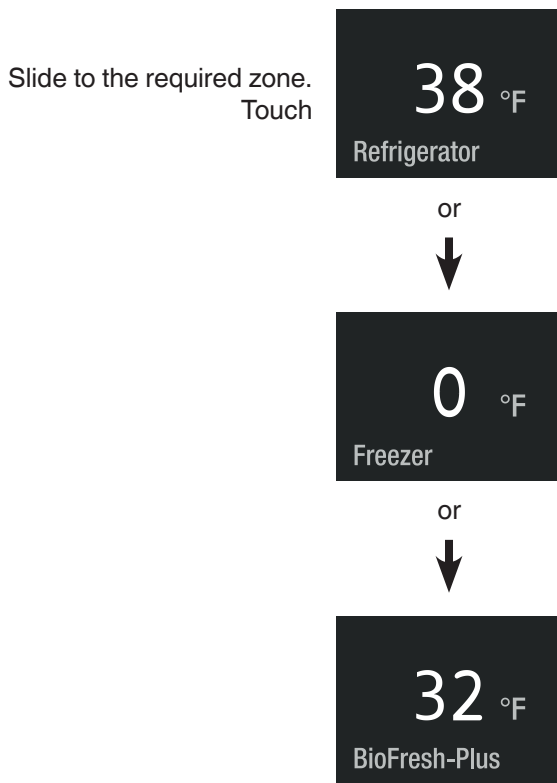

IMPORTANT

The temperature in the warmest section of the appliance may be higher than the set value.

Setting the Temperature (Refrigerator Compartment)

Standard setting is 38°F.

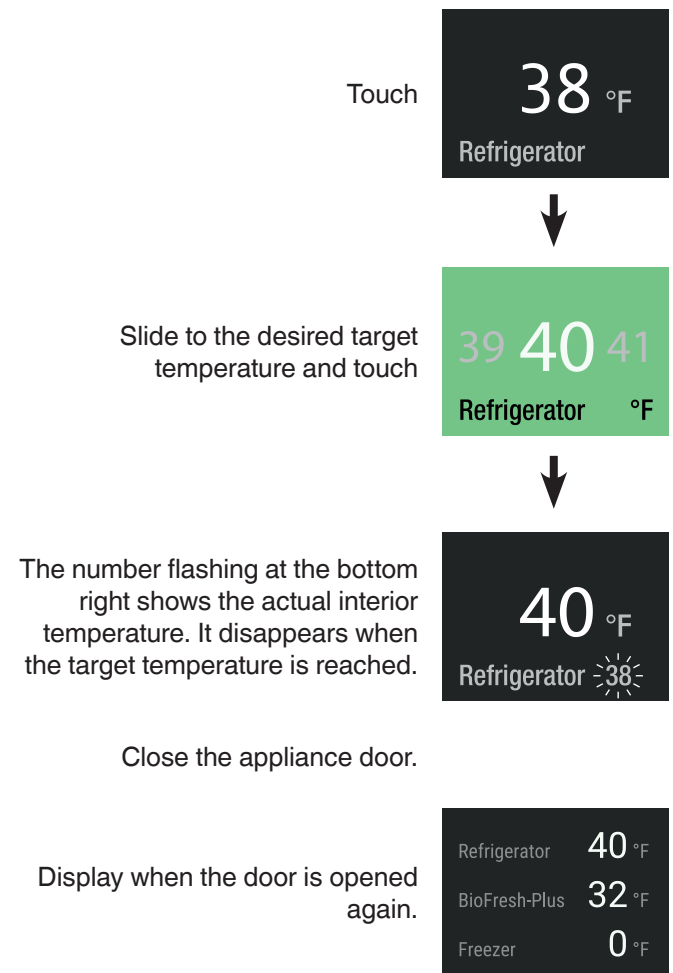

The refrigerator temperature display flashes if the actual refrigerator temperature is different to the target temperature. It stops flashing when the target temperature is reached.

The temperature can be set at between 36°F and 45°F (2°C and 7°C).

Setting the Temperature (Freezer Compartment)

Standard setting is 0°F.

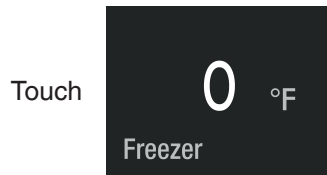

Slide to the desired target temperature and touch



The number flashing at the bottom right shows the actual interior temperature. It disappears when the target temperature is reached.



Close the appliance door.

Display when the door is opened again.



The temperature display blinks if the actual interior temperature is different to the target temperature. It stops blinking when the target temperature is reached.

The temperature can be set at between 7°F and -15°F (-14°C and -27°C).

Setting the Temperature (BioFresh-Plus Compartment)

Standard setting is 32°F.

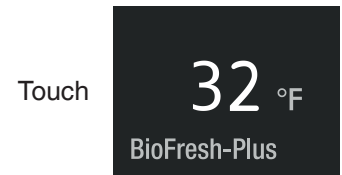

Slide to the desired target temperature and touch

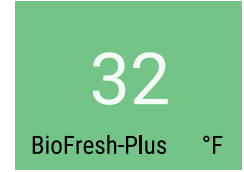

or

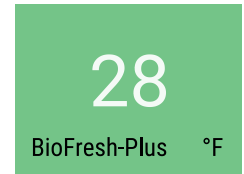

or

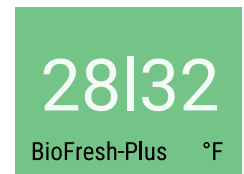

An additional drawer divider must be inserted to select 28°F / 32°F.

Temperature range on the left-hand side of the drawer: 28°F
Temperature range on the right-hand side of the drawer: 32°F

IMPORTANT

There is no need to remove the drawer divider for setting to 32°F or 28°F. The temperature will be adjusted in both compartments of the drawer.

For dual temperature please ensure the drawer divider is inserted.

Pull the drawer straight out, grip at the back and lift out.

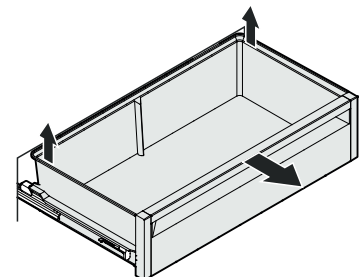

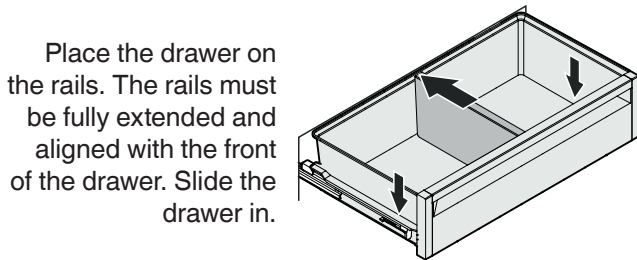
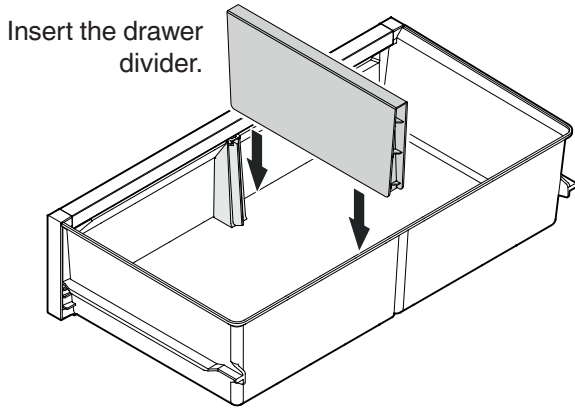
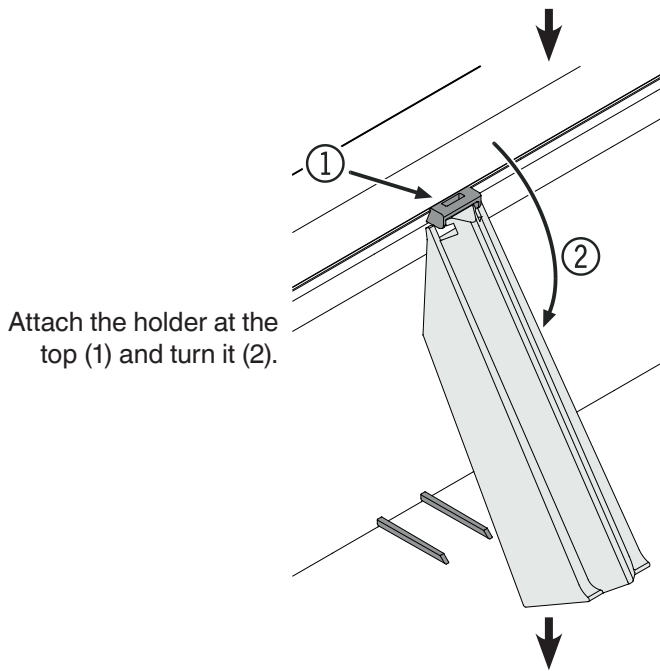

Close the appliance door.

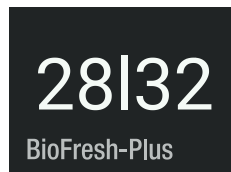

Display when the door is opened again.



SuperCool

Activate SuperCool if you wish to cool large quantities of food rapidly. The set temperature is 36°F.

Touch

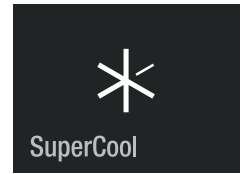

SuperCool is activated. At top right, the remaining run time of 6 hours is visible. When this time is up, the appliance switches back to normal operation.

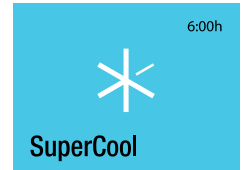

Close the appliance door.

Display when the door is opened again.

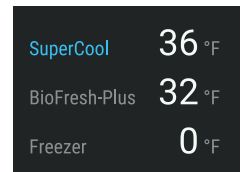

To change the temperature, SuperCool must be deactivated. Touch the display.

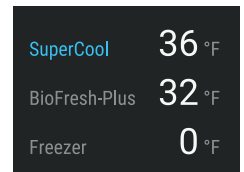

Touch

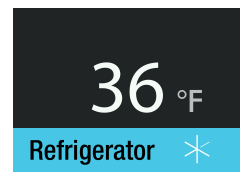

Touch

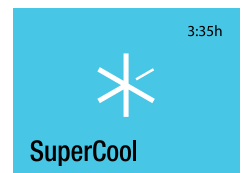

SuperCool is deactivated.



SuperFrost

Fresh food should be frozen completely and as rapidly as possible. This is provided by the SuperFrost feature and ensures that the nutritional value, appearance and flavor of the food remains intact.

Touch

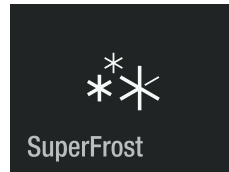

SuperFrost is activated.

Wait 24 hours. Then place the food inside and close the appliance door.

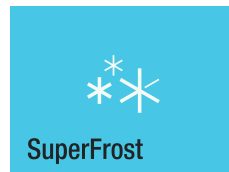

Display when the door is opened again.

The SuperFrost function turns off automatically between 30 and 65 hours depending on the quantity of food placed inside.

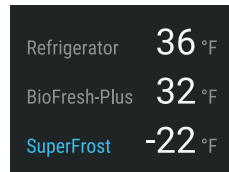

To deactivate SuperFrost earlier, touch the display.

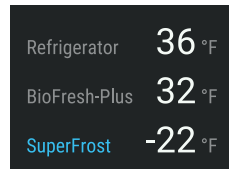

Touch



Touch

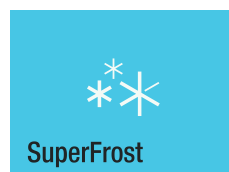

SuperFrost is deactivated.

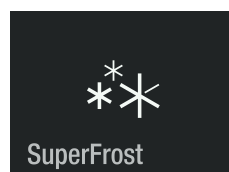

Freezing and Storage

- Pack frozen food in standard freezer bags or reusable plastic, metal or aluminum containers.
- Do not allow fresh food which is to be frozen to come into contact with food already frozen. Always keep packages dry in order to avoid them sticking together.
- Always write the date and contents on the package and do not exceed the stated storage time for the food. This prevents spoiling.
- Pack food which you are freezing yourself in quantities right for your household. To ensure the food freezes right through quickly, the following quantities should not be exceeded per package:
 - fruit, vegetables: up to 2-1/4 lbs (1 kg);
 - meat: up to 5-1/2 lbs (2.5 kg).
- Do not freeze bottles and cans which contain carbonated drinks as they might burst. Drinks can be cooled down quickly, but take the bottles out of the freezer compartment after an hour at the most.
- Only take out as much food as needed for thawing. Cook food which has been thawed as quickly as possible.

Frozen food can be thawed in the following ways:

- in a microwave oven
- in the refrigerator: the safer way to thaw food because there is less chance of bacteria growth. Use this method for high density food such as roasts or poultry.

Safety Instructions and Warnings for the Ice Maker

- The ice maker is designed exclusively to make ice cubes in quantities needed by a household.
- All repairs and work on the ice maker may only be done by customer service personnel or other appropriately trained personnel.
- **Do not consume or use the first three batches of ice. This applies both to using the appliance for the first time and also using it after it has not been used for a long period of time.**
- **The manufacturer cannot accept liability for damage caused by equipment or water lines between the solenoid valve and the water supply.**

Ice Maker Description

The IceMaker is in the top drawer of the appliance.

The ice cubes fall out of the ice maker into the drawer.

When the ice reaches a certain level in the drawer, the appliance stops producing ice automatically.

After you start the ice maker for the first time, it may take up to 24 hours before the first ice cubes are ready.

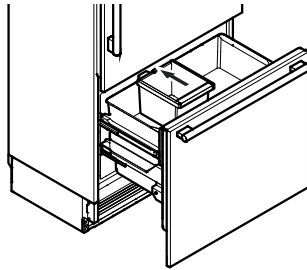

IMPORTANT

The first three batches of ice must not be consumed or used.

Switching the IceMaker on

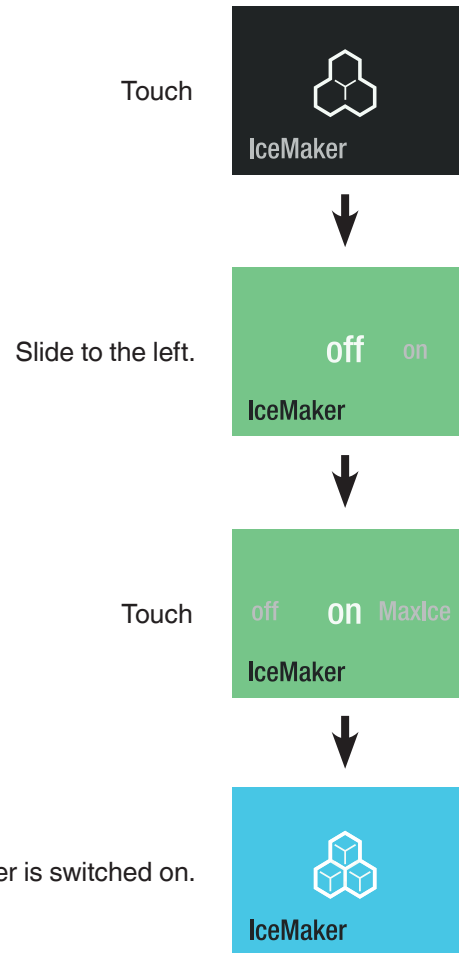

The production capacity is 100 - 120 ice cubes in 24 hours at a temperature of 0°F (-18°C) inside the freezer compartment.

Switching the Ice Maker Off

IMPORTANT

Additional steps required to decommission the appliance or for a lengthy absence.

- Switch off the water supply.
- Wait for 24 hours or until the water alarm appears.
- Disable the ice maker.

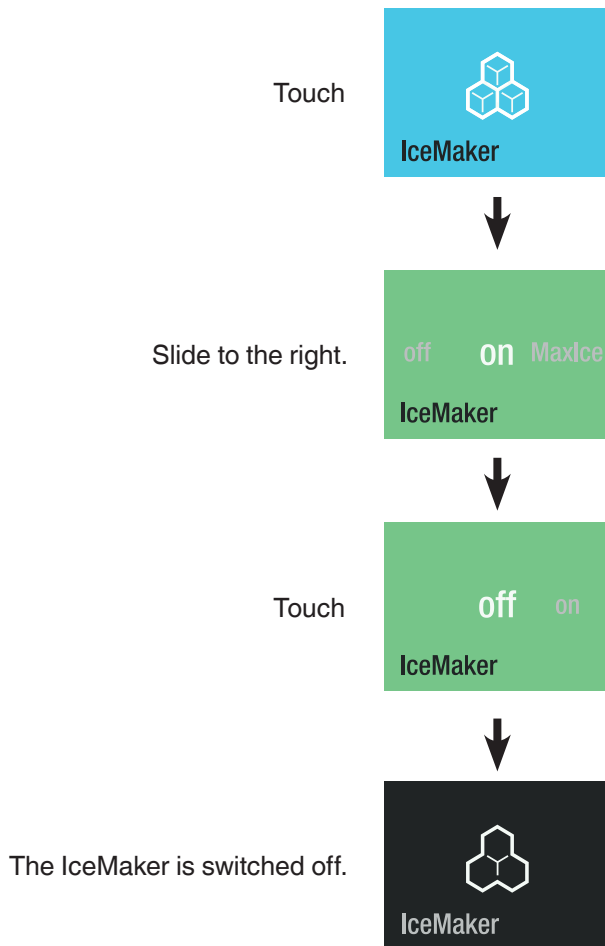

Switching the IceMaker to Maximum Ice Production

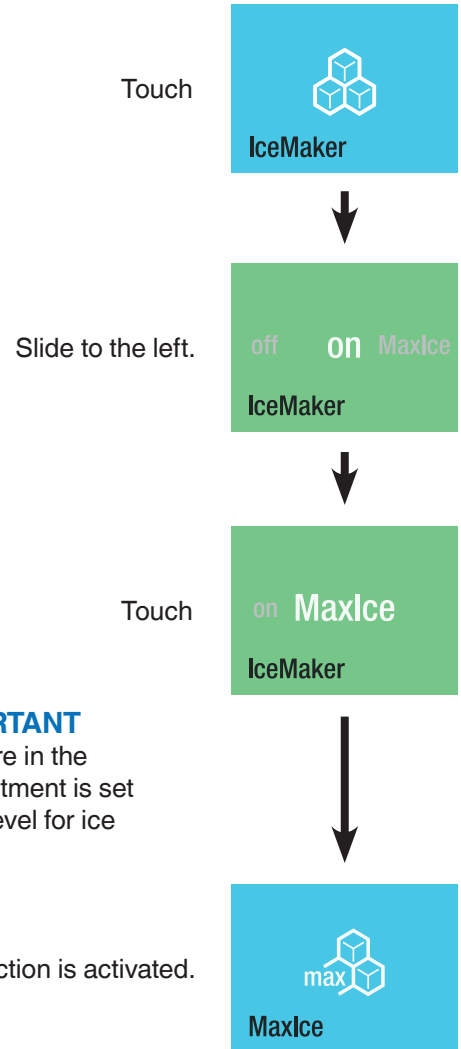

IMPORTANT

The temperature in the freezer compartment is set to the perfect level for ice production.

The MaxIce function is activated.

IMPORTANT

Maximum ice production is switched off after 36 hours.

The production capacity is approx. 150 ice cubes in 24 hours.

Be aware that this increases the energy consumption slightly.

PartyMode

When a large amount of cold food or beverages is needed: Place all the food and beverages in the appliance one day before and activate PartyMode. SuperCool is activated in the refrigerator compartment and maximum ice production in the freezer compartment.

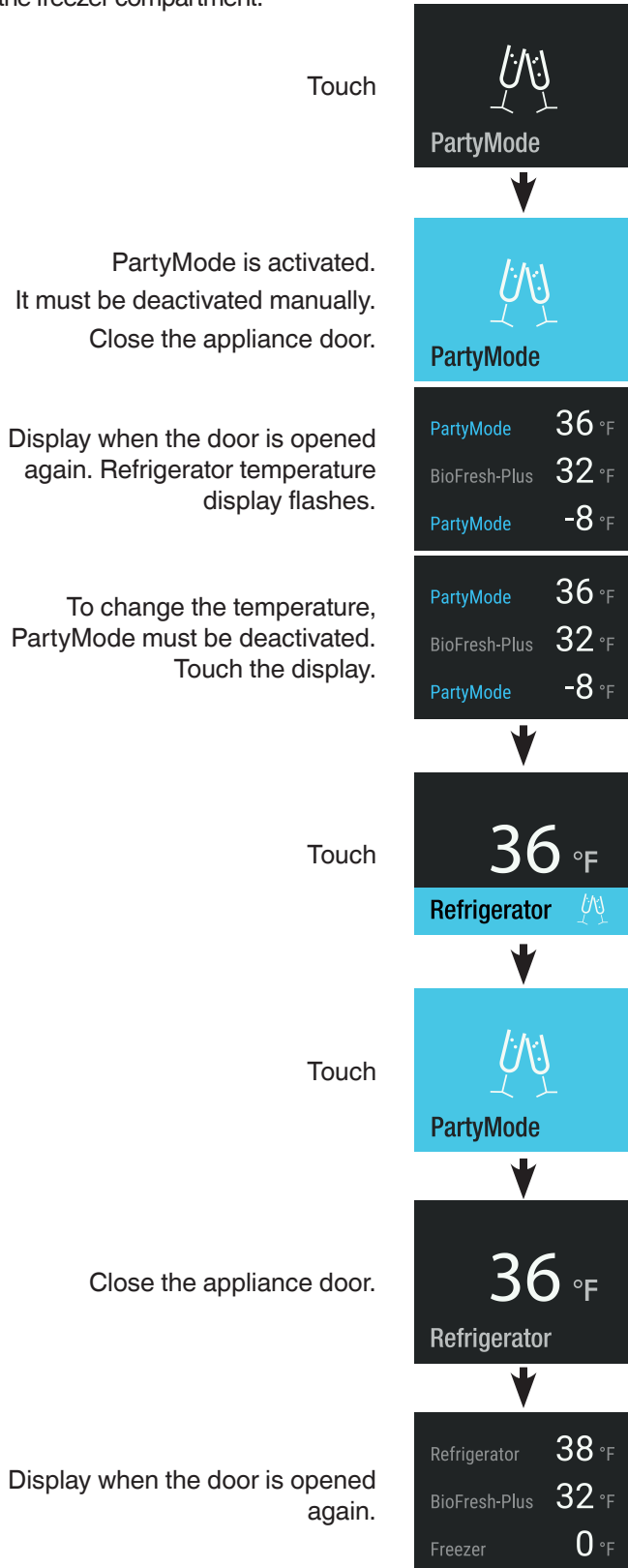

HolidayMode

Before a lengthy absence, use up all the food in the refrigerator compartment and activate HolidayMode. This ensures that no unpleasant odors develop inside the appliance, even if the appliance door is closed. (The temperature in the refrigerator compartment is increased to 59°F.) The current cycle for ice cubes will be completed in the freezer compartment and the ice maker will be disabled.

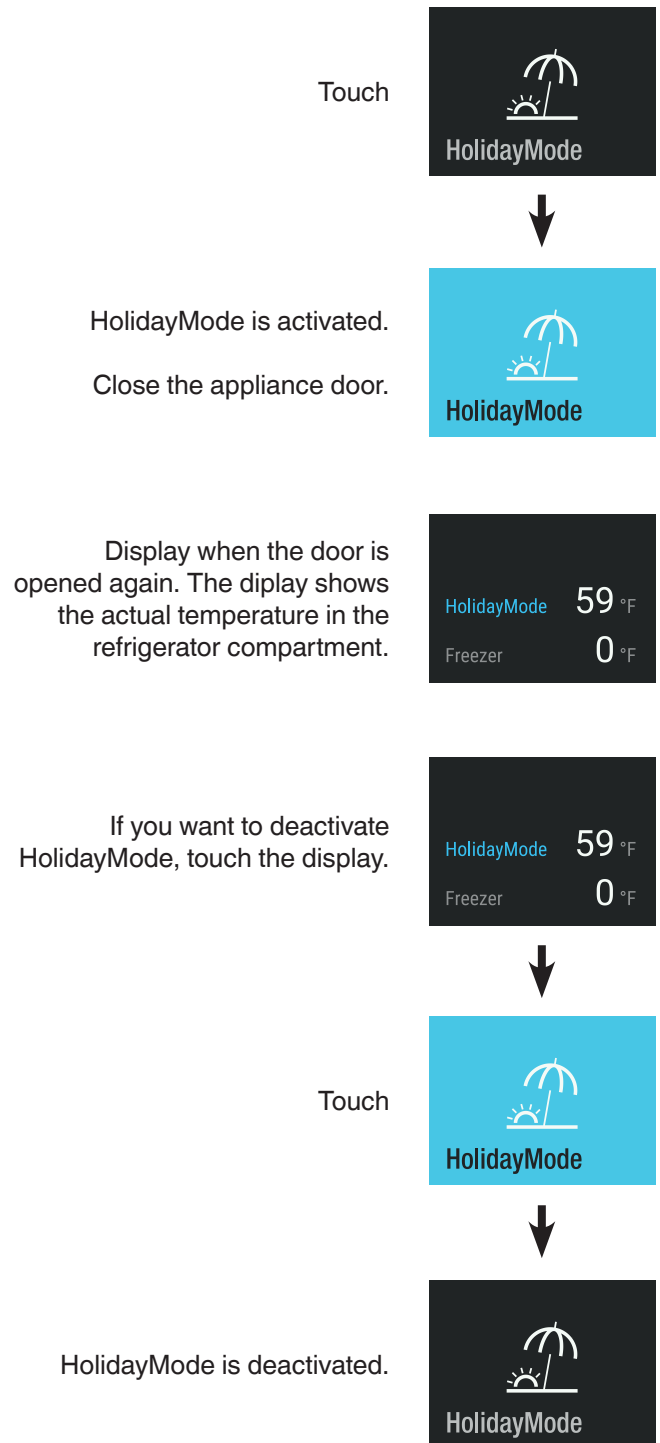

SabbathMode

When SabbathMode is active, some functions of the electronic features are switched off to comply with STAR-K Kosher Certification.

- The lighting remains off.
- The cooling fan remains in its actual state: If it is on, it remains on, if it is off, it remains off.
- There is no door alarm.
- There is no temperature alarm.
- Defrost cycles are independent of the number of times and length of door openings.
- The unit will return to SabbathMode after a power failure.

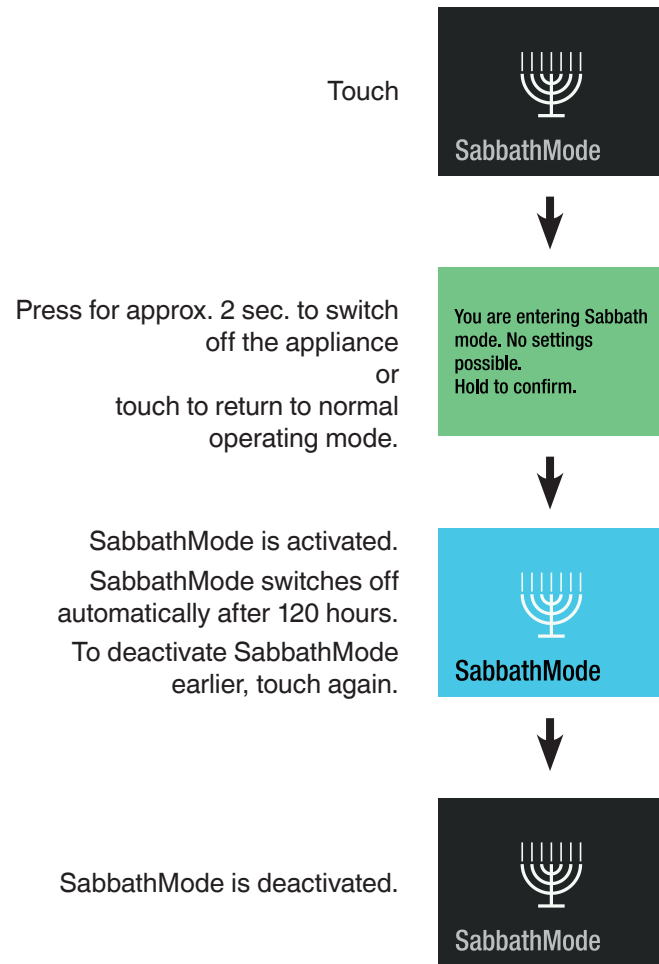

Switching the Appliance Off

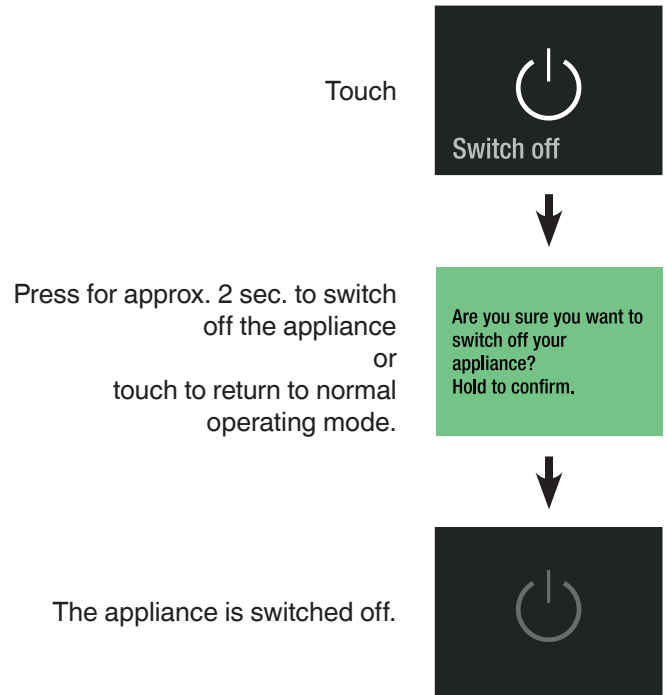

Maintenance Message

In regular intervals of operation of the appliance, the maintenance message comes on (6 months). Filters need to be changed. The water dispenser needs to be flushed. The dust filter needs to be cleaned.

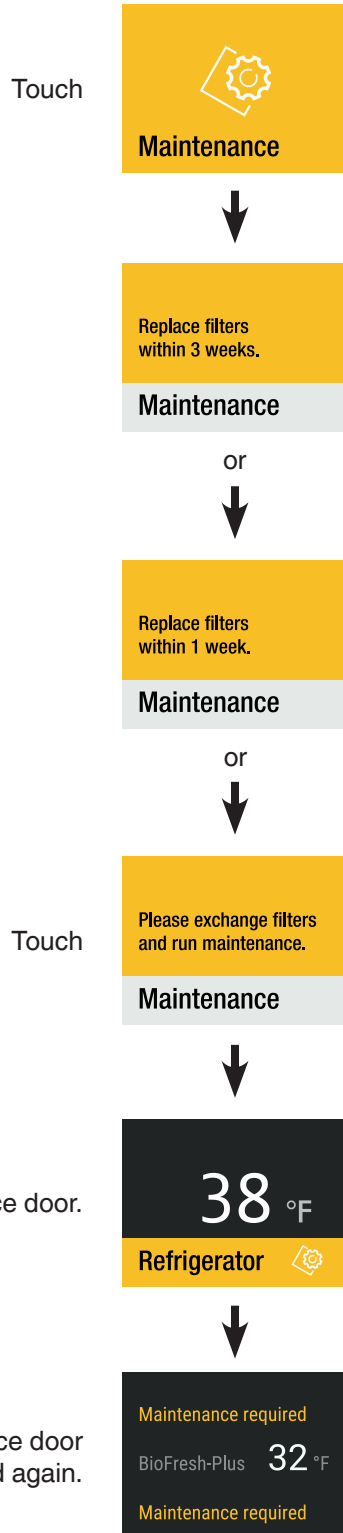

Obtain water filter and air filter from your dealer and complete the maintenance procedure.

Maintenance Confirmation

IMPORTANT

Remove ice cubes from the IceMaker before starting maintenance.

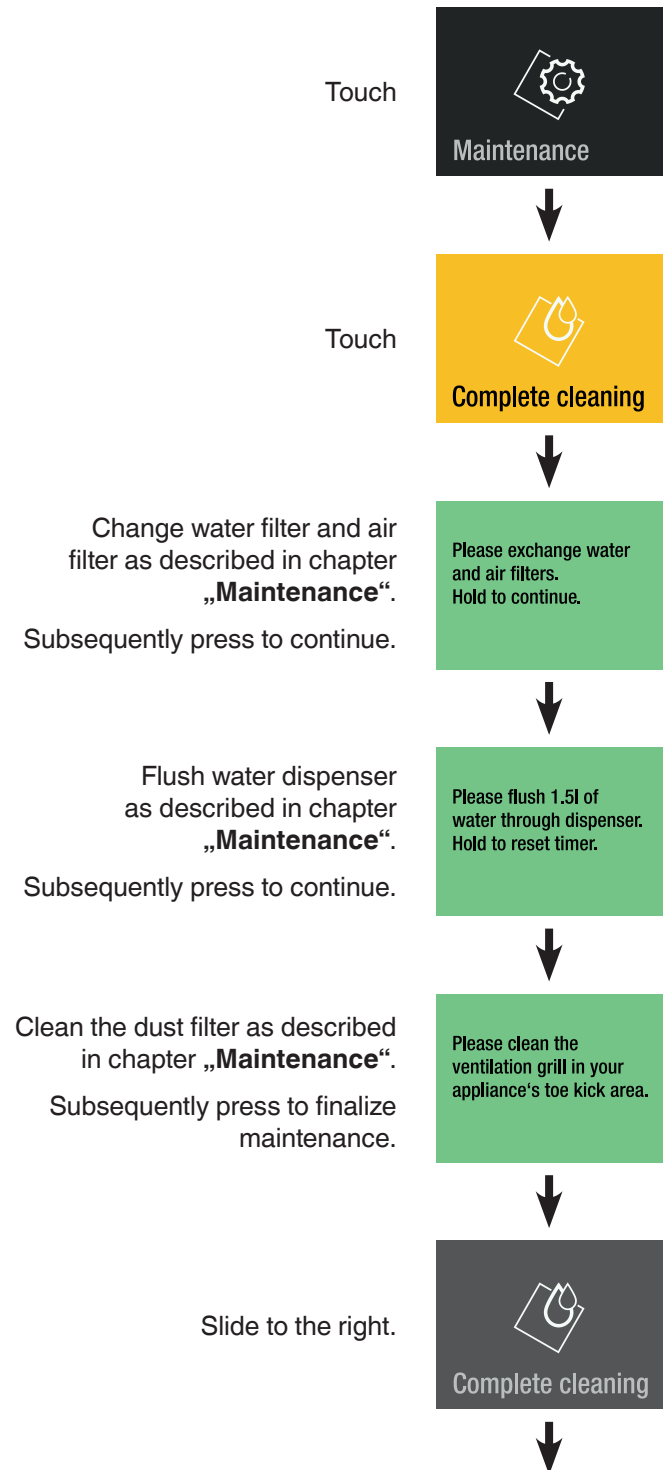

Touch to exit maintenance.

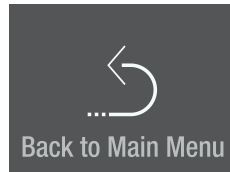

IMPORTANT

The first three batches of ice must not be consumed or used, a reminder appears.

Maintenance reminders after 3 cycles.

Touch



Please remove and dispose of ice cubes from the drawer.

Touch

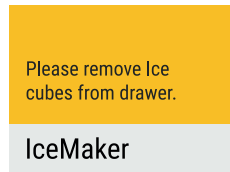

Setup Menu

Includes the adjustment for display brightness, language, units, activation of the SmartDeviceBox and the device information.

Touch

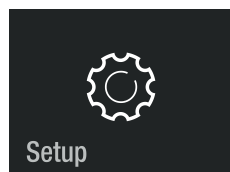

Slide to the left.

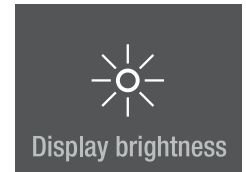

Slide to the left.

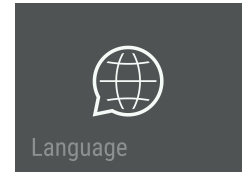

Slide to the left.

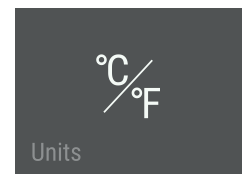

Display shows the device information.

Slide to the right.

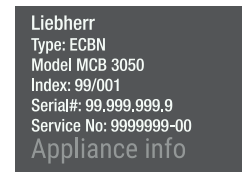

Slide to the left.

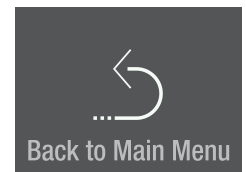

Slide to the left.
(Only visible when the SmartDeviceBox is fitted.)

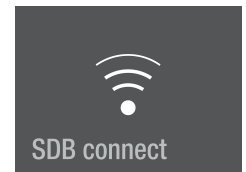

Touch to exit.

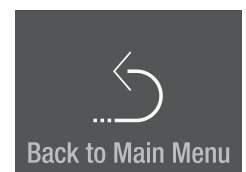

Display Brightness

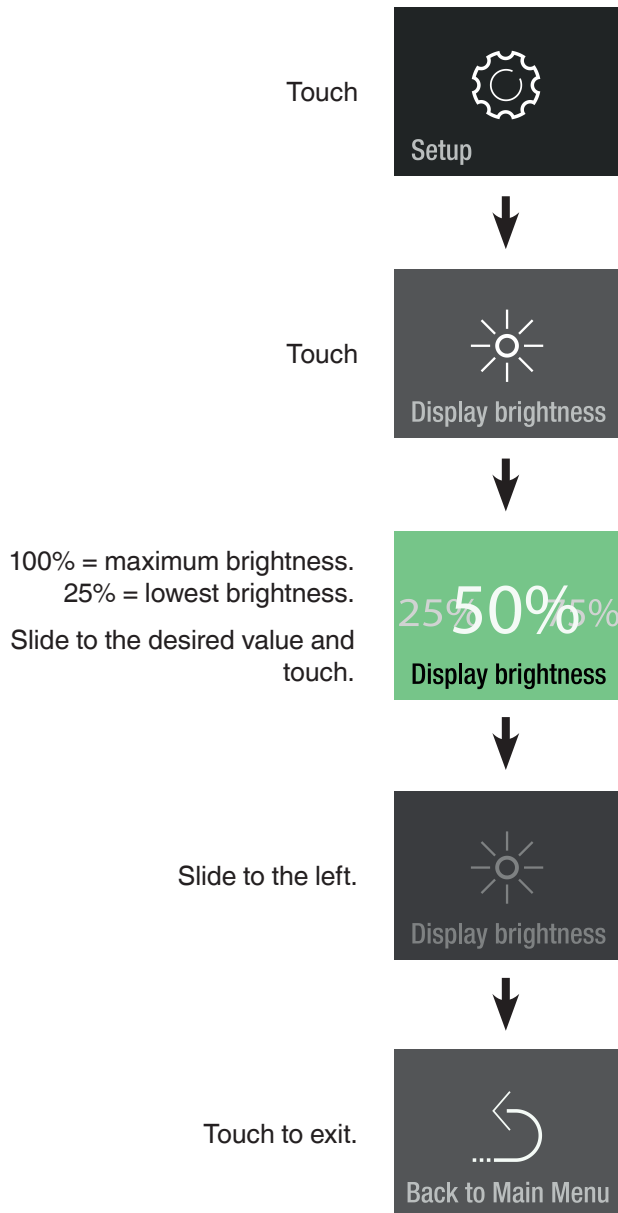

Language

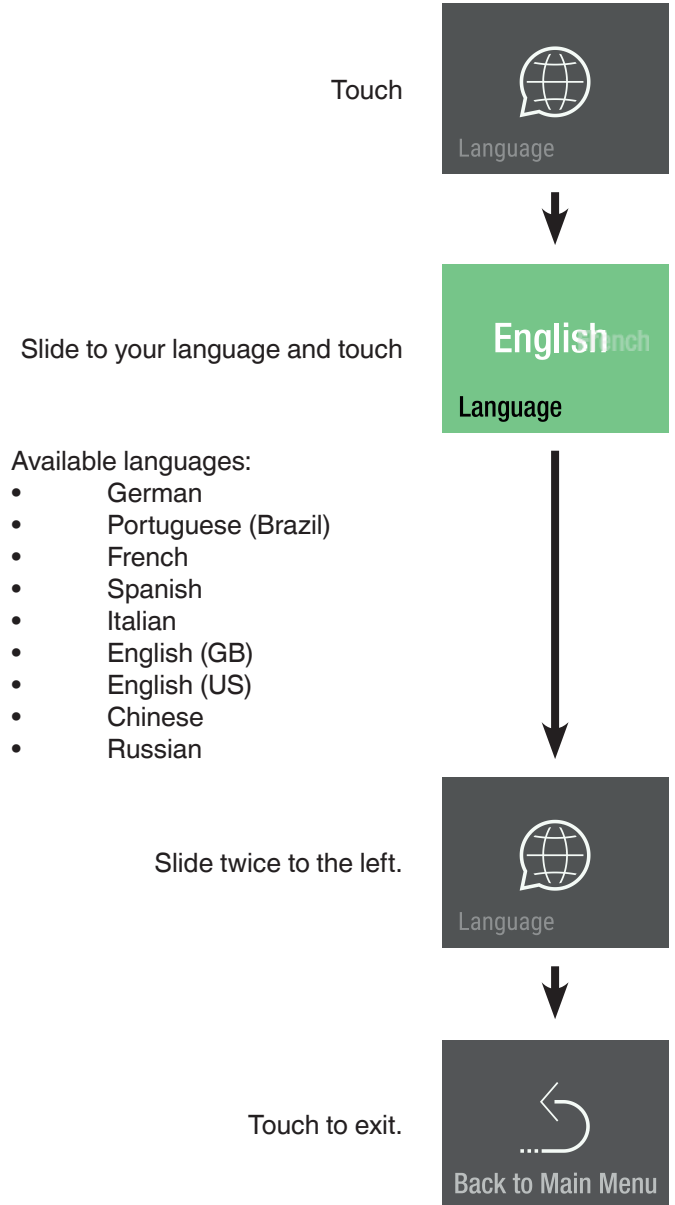

Units

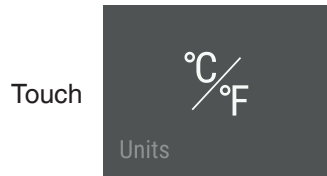

Slide to the desired temperature unit and touch

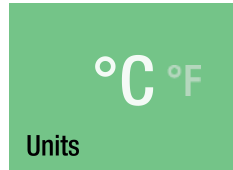

Slide to the left.

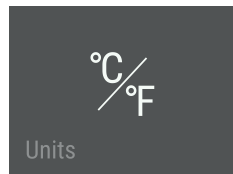

Touch to exit.

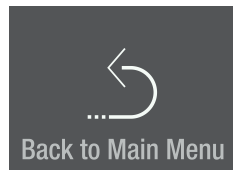

SmartDeviceBox (Not Supplied in All Countries)

The appliance is ready for integration into a smart home and for extended services.

Other options can be selected with a SmartDeviceBox.

This is activated via the MyLiebherr customer portal.



You will find more information about availability and prerequisites and the individual options on the website www.smartdevice.liebherr.com/info.



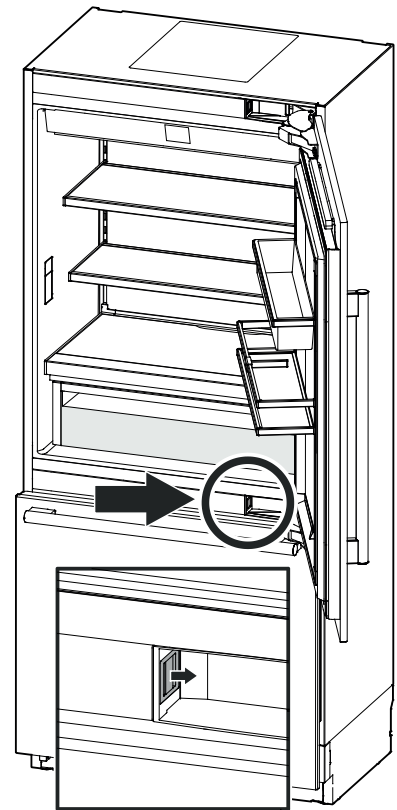

Download the “SmartDevice App” to your smartphone.

Start the app on your smartphone and follow the instructions.

SmartDevice functions are not available in all countries.

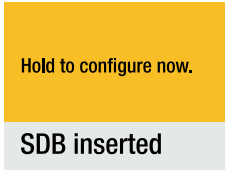
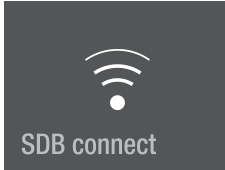

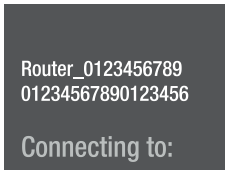
Description of the SmartDevice Displays

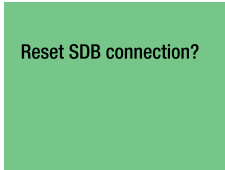
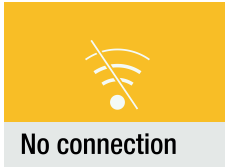
SmartDeviceBox is inserted.	
Display to start the WLAN connection.	
The symbol flashes. Connection to WLAN is in progress.	
The router credentials are displayed.	
Appliance is connected to WLAN.	
Connection reset	
This message informs you of any router or Internet problems.	

Alarm Messages

Door Open Alarm

Door has been left open for longer than about 180 seconds.

Action
Close the appliance door.



Electronic Fault Alarm

Electronic fault.

Touch

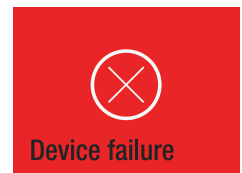

Action
Contact service, stating the failure code displayed.

Touch



Touch

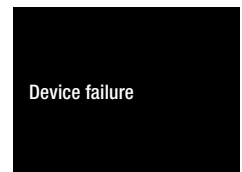

Press

Press for approx. 2 seconds to read failure number again.

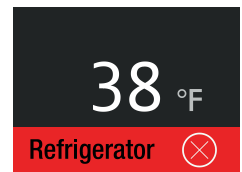

Temperature Alarm

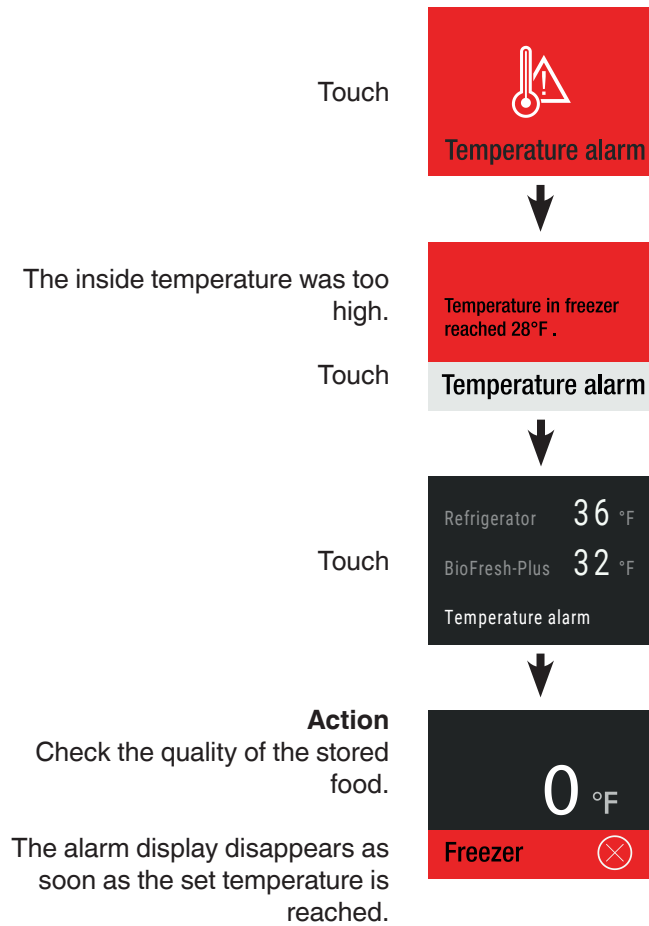

Water alarm

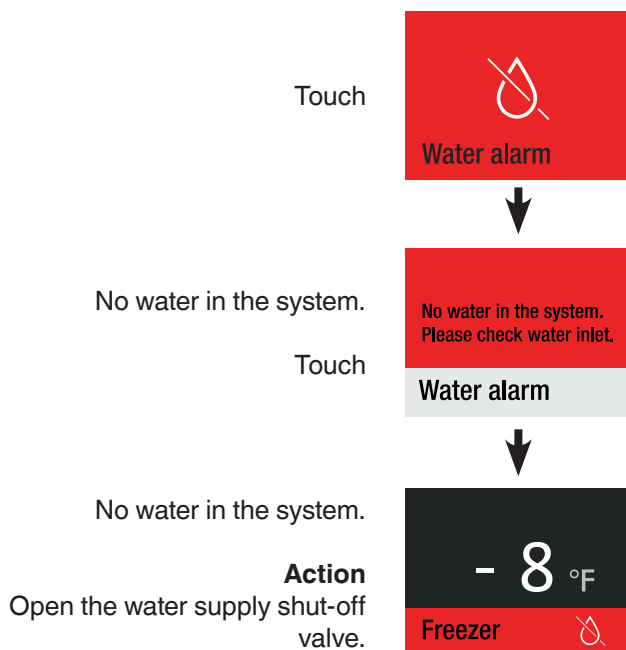

Power Alarm

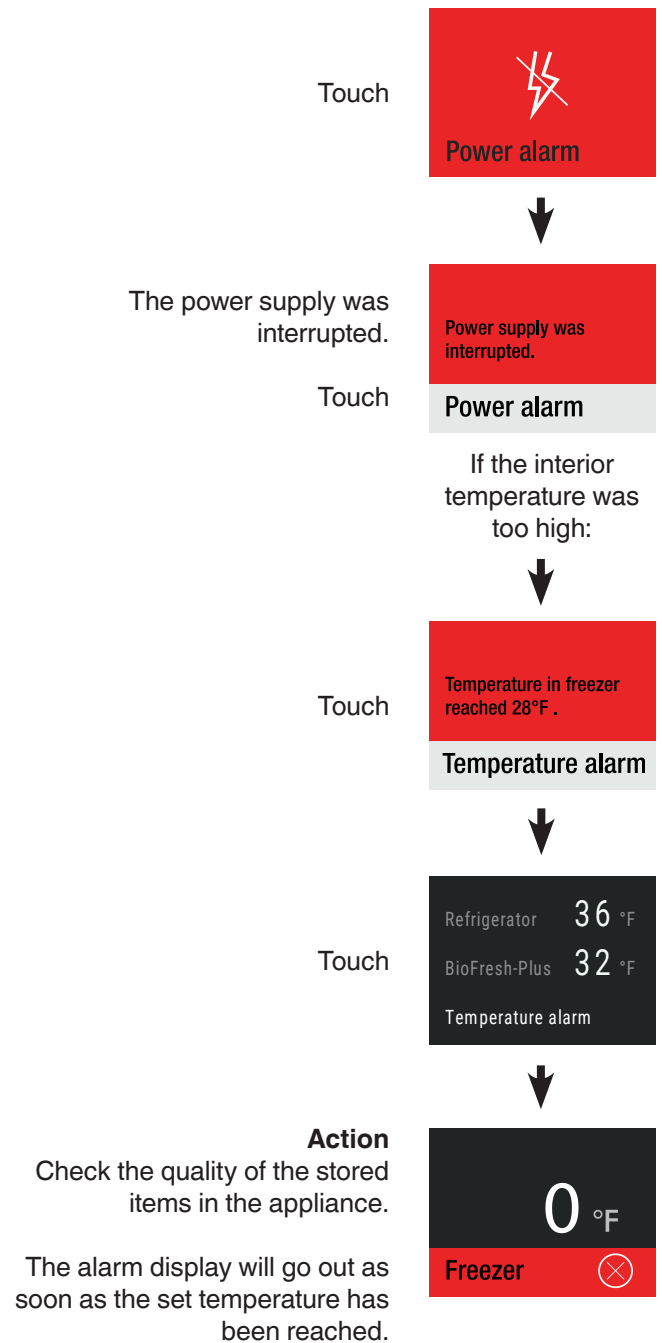

Ice Maker Alarm

Touch



Action

Contact service, stating the failure code displayed.

Failure XX0000
Please contact service.
IceMaker is off

Touch

IceMaker failure



The ice maker is disabled.
There is no need to move any
items to another appliance.

Refrigerator 40 °F
BioFresh-Plus 32 °F
Freezer 0 °F

The menu will continue to show
the "IceMaker failure" error until it
has been rectified by the service
team.



Connection Failure

Touch



Action

Contact service, stating the failure code displayed.

Failure XX0000
Please contact service.

Touch

Connection failure



The connection is disabled.
There is no need to move any
items to another appliance.

Refrigerator 40 °F
BioFresh-Plus 32 °F
Freezer 0 °F

The menu will continue to show the
"Connection failure" error until it
has been rectified by the customer
service team.



Equipment

You can rearrange the height of the shelves and door racks as required.



Risk of injury and damage.

Do not attempt to adjust a shelf or door rack with food on it.

Only adjust an empty shelf or door rack.

Repositioning the shelves

Removing

Lift the shelf up and move out toward you.

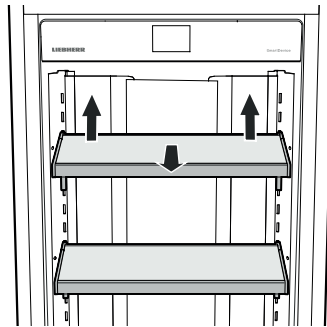

Installing

Insert the hooks of the shelf into the openings of the clip-in strip at the desired height and push down.

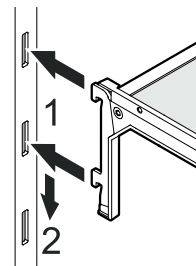

Repositioning the door racks

Removing

Lift the rack up and move out toward you.

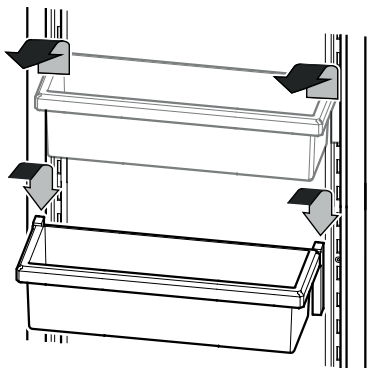

Installing

Insert the hooks of the rack into the openings of the clip-in strip at the desired height and push down.

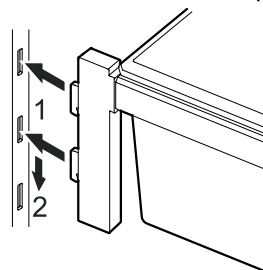

Gallon rack bottle holder *

You can protect the bottles from falling over when the door is opened and closed.

Move the bottle holder to the desired position.

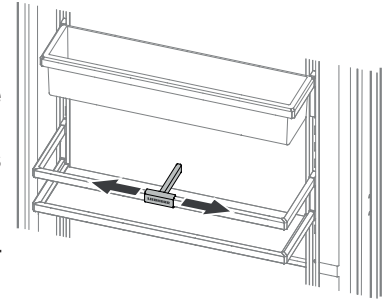

Bottle tray

The tray above the BioFresh compartment can be used for storing bottles horizontally.

Remove glass plate.

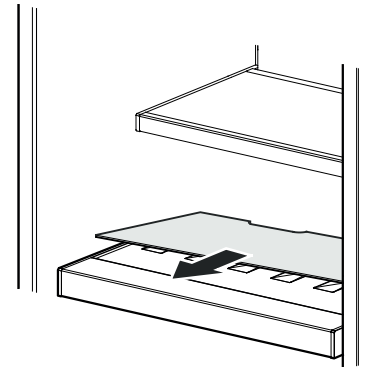

IMPORTANT

When storing tall bottles (higher than 9 inches), the gallon rack must be relocated to a higher position to avoid collision between the gallon rack and the bottles.

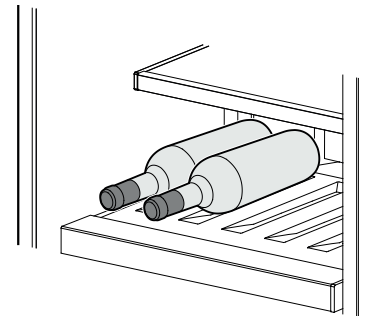

* Depending on model and options

BIOFRESH-PLUS COMPARTMENT

Water Dispenser

Press a drinking glass against the bottom part of the dispenser. The top part moves out and the water flows into the glass. (max. actuation duration 2 minutes → waiting time before reuse 4 minutes)

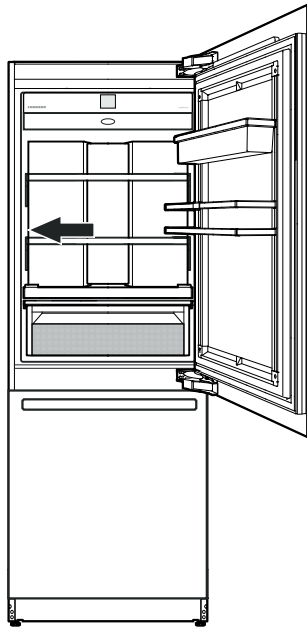
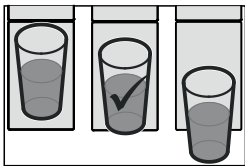
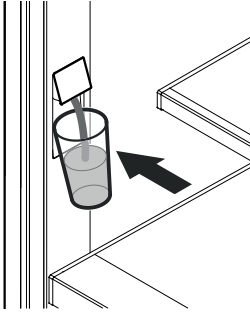

BioFresh-Plus Compartment

Set the temperature of the BioFresh-Plus compartment in accordance with the type of stored food. See chapter „Setting the Temperature (BioFresh-Plus Compartment)“.

Set to 32°F (factory setting) for storing fruit, vegetables, meat, cold meats or dairy products.

Set to 28°F for storing of fish or seafood. Storage time is 3 days at the most.

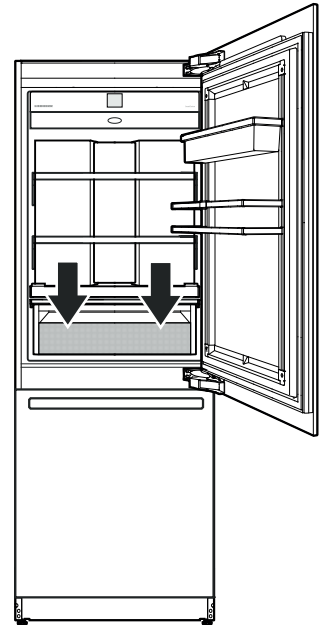

IMPORTANT

The water temperature is determined by the appliance setting and the water intake temperature.

Notes

- The humidity in the compartment depends on the moisture content of the food and the frequency with which a drawer is opened.
- The fresher the product and the higher its quality, the longer the storage life.
- Unwrapped food should be stored separately. Wrap food if there is not enough space in the drawers. To avoid bacterial spoilage, different types of meat should not come into contact with each other. Keep meat packed separately.
- The following products should not be stored in the BioFresh-Plus Compartment: hard cheese, potatoes, cold-sensitive vegetables such as cucumber, egg-plant, avocados, semi-ripe tomatoes, zucchini, and all cold-sensitive tropical fruits.

Cleaning

WARNING!

- To prevent possible injury due to an electric shock, be sure to disconnect the power cord or turn off the circuit breaker before cleaning the appliance.
- To avoid injury or damage, do not use steam cleaning equipment to clean the appliance.
- To avoid short-circuits, ensure no cleaning water penetrates into the electrical components when cleaning the appliance. Do not use a sponge or cloth that is overly wet.
- Take food out of the appliance and store it in a cool place.
- Rinse or flush the water system after 5 days if it has not been used, see „Maintenance Menu“.
- Remove the glass shelves and door racks. Refer to chapter „Equipment“.

- Remove the drawers.

Pull the drawer straight out, grip at the back and lift out.

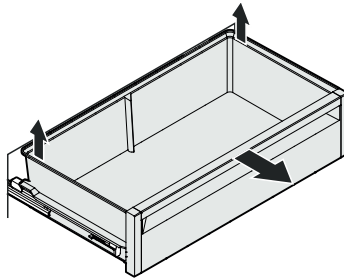

- Pull the freezer drawer upwards by its right and left bottom corners (1). Push the container backwards (2). Set the container to an angle and remove it (3).

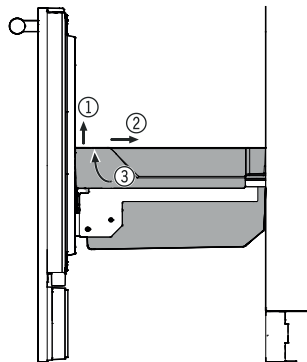

- The bottommost freezer drawer must be removed to clean the glass plate in the freezer compartment.

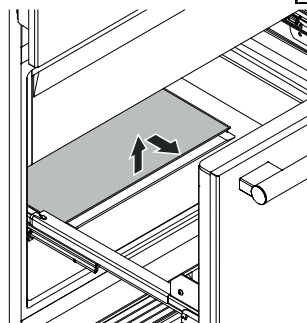

- Clean the inside of the appliance and equipment parts with lukewarm water and a little detergent.

IMPORTANT

Do not use abrasive or scouring pads or sponges. Do not use concentrated cleaning agents. Never use abrasive or acid-based cleaners or chemical solvents.

- Clean the pull-out rails with a slightly dampened cloth only.

IMPORTANT

No cleaning water must be allowed to get into the pull-out rail guides.

- Dry all parts well with a cloth.

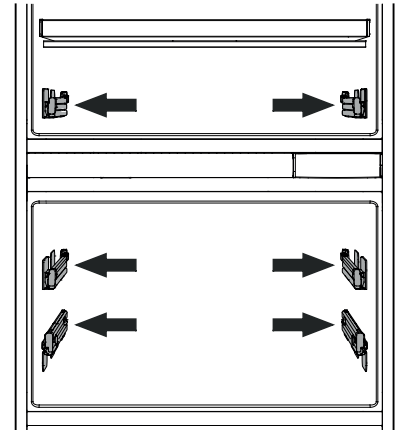

- **Do not** damage or remove the model plate on the inside of the appliance. It is very important for servicing your appliance.

- Install the drawers.

Place the drawer on the rails. The rails must be fully extended and aligned with the front of the drawer. Slide the drawer in.

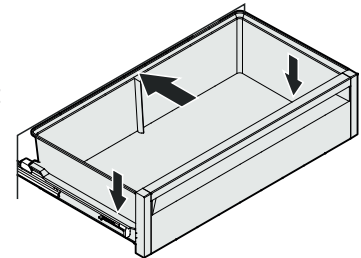

- Install all equipment parts and replace the food in the appliance. Refer to chapter „Equipment“.
- Turn the appliance on.

MAINTENANCE

Maintenance Menu

Maintenance can be carried out independently of the specified regular intervals. The maintenance menu includes the following steps.



Complete cleaning

For complete maintenance of the appliance.

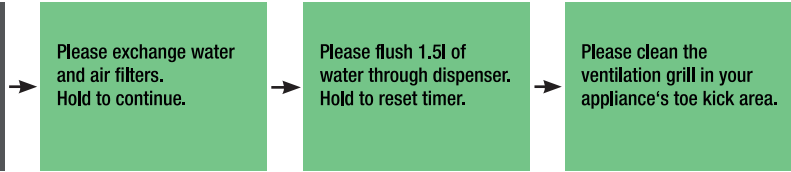

Dispenser cleaning

To interrupt the water supply for cleaning the dispenser outlet.

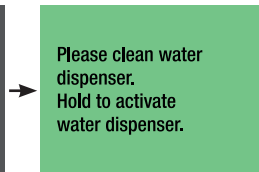

New water filter

To flush and reset maintenance timer.

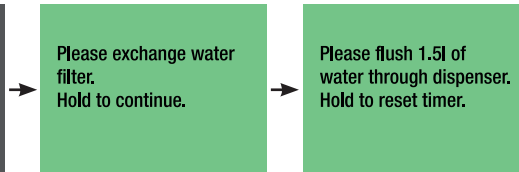

New air filter

To reset maintenance timer.



Flush cleaning

To flush the water dispenser when the dispenser has not been used for a longer period of time.

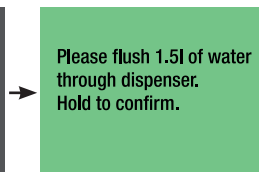
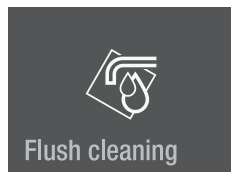

To return to the main menu.

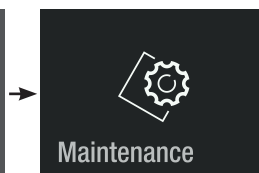
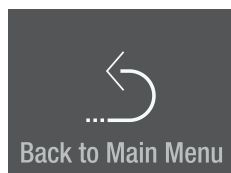

Maintenance

New water filter

The inserted water filter absorbs deposits in the water and reduces the taste of chlorine.

IMPORTANT

To avoid reduction of the water flow rate of the dispenser, the water filter should be changed at least at the indicated maintenance intervals.

If noticeable water flow reduction occurs, the water filter should be changed sooner.

Note

It is not necessary to turn off the water supply when removing or inserting the filter.

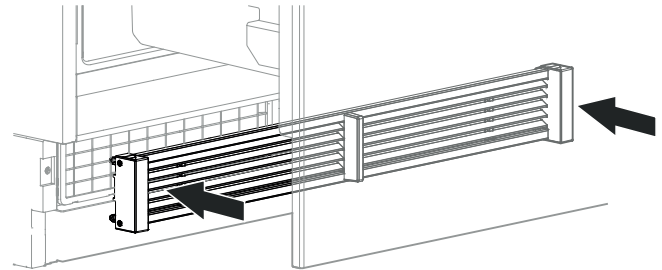

Mount the ventilation grille.

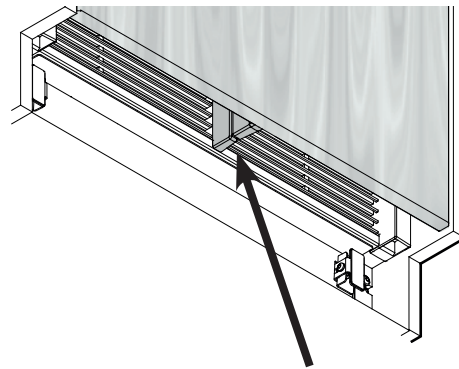

Check that there is no gap between the appliance air divider and the door air divider.

IMPORTANT

There will be a gap if the ventilation grille is fitted incorrectly.

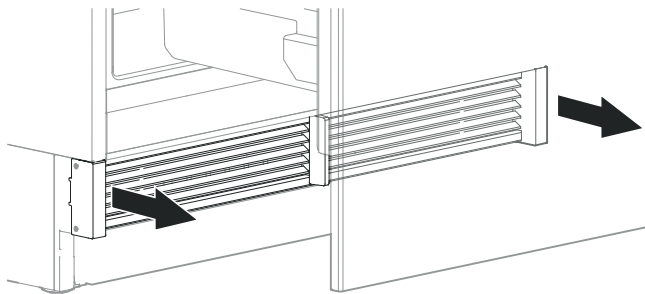

Remove the ventilation grille.

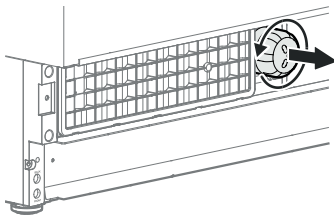

Turn the water filter counterclockwise and remove.

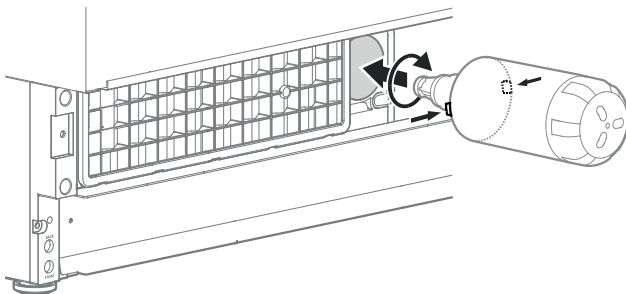

Insert the water filter - with the knobs at the front in a horizontal position - as far as it will go, and turn clockwise until it snaps in.

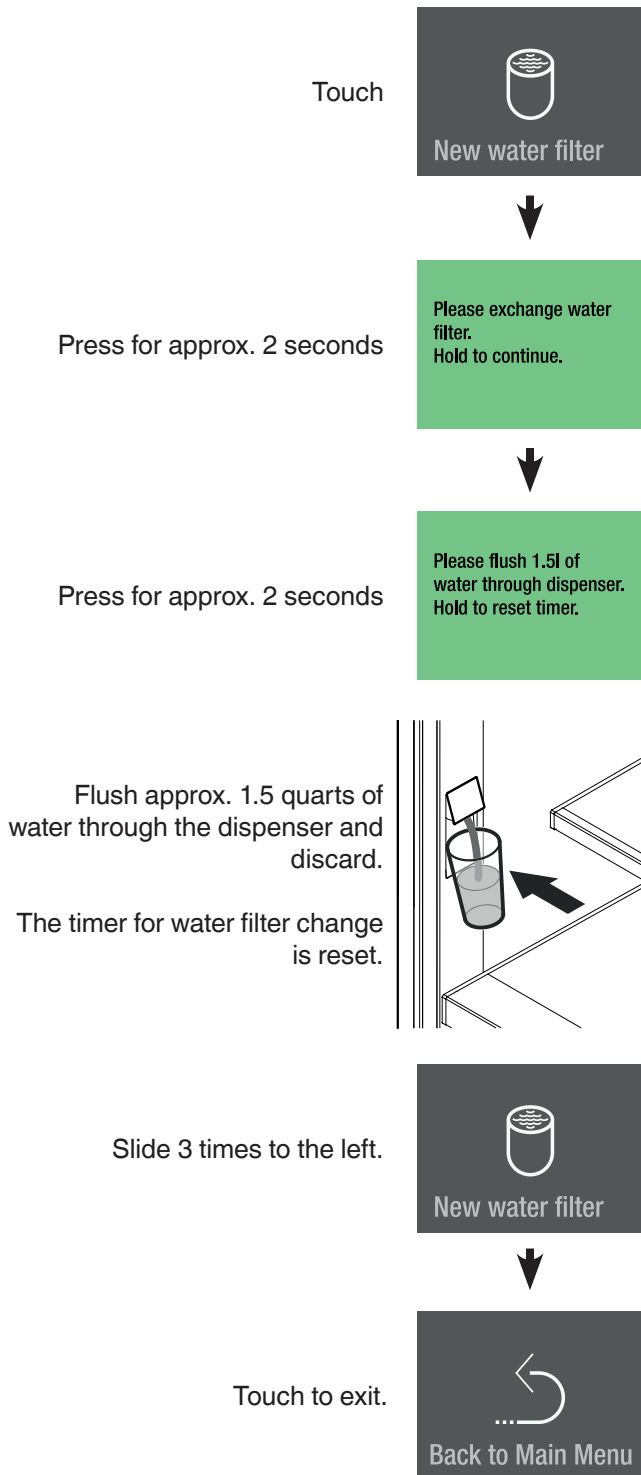

Dispenser cleaning

The dispenser outlet and the surrounding area can be cleaned without disconnecting the appliance from the electrical power supply.

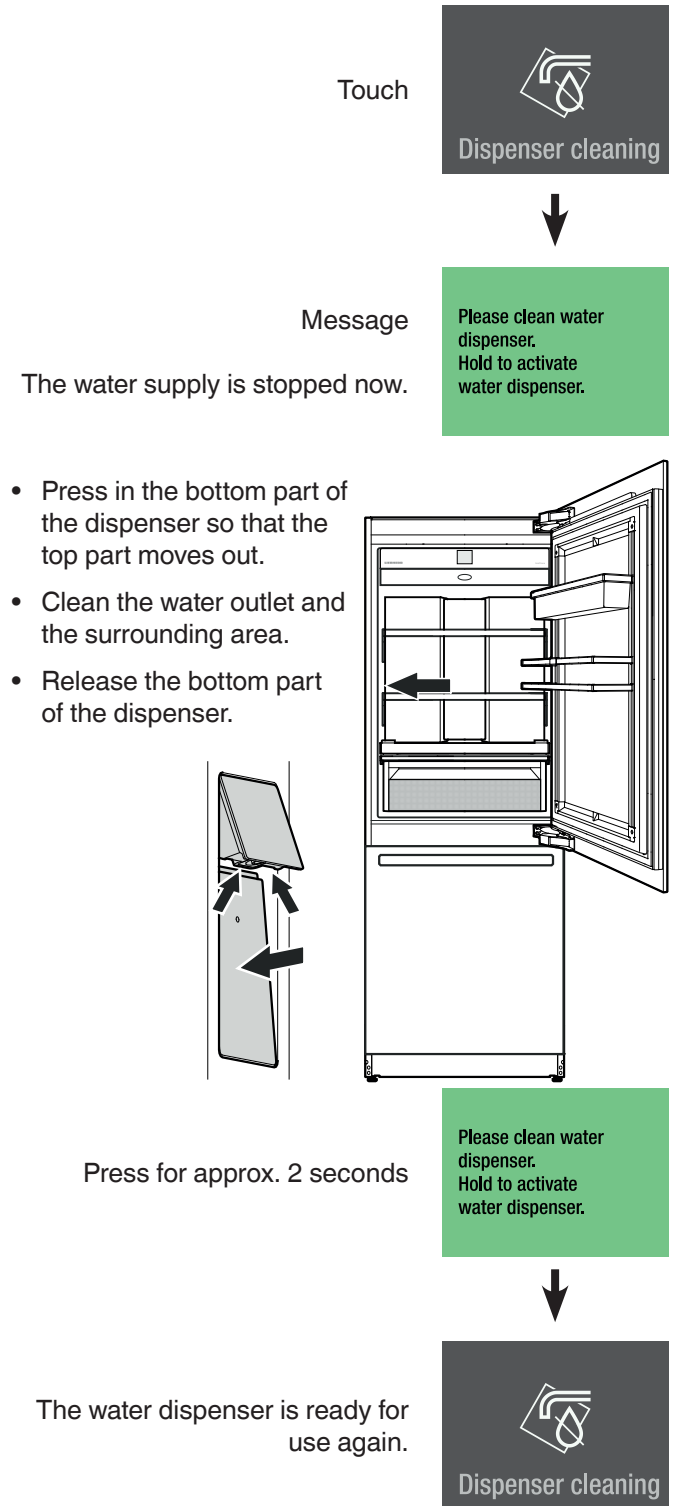

If the water flow is no longer even, the aerator must be replaced (see contact details on the back of this manual).

New air filter

The air filter absorbs odors from the appliance interior. It should be changed at least at the indicated maintenance intervals.

Touch

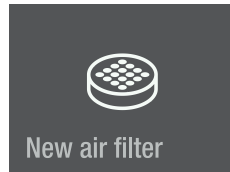

New air filter



Message

Please exchange air filter.
Hold to reset timer.

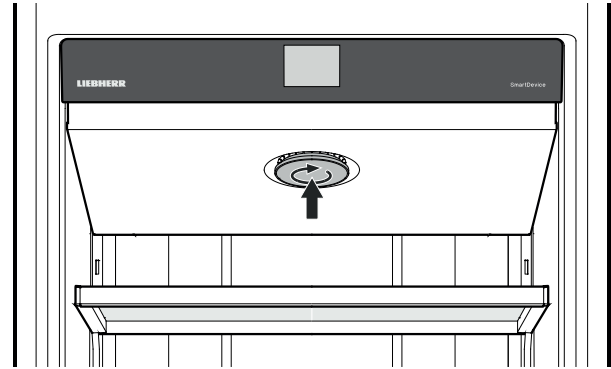

Insert the cover and turn clockwise until it snaps in.

Press for approx. 2 seconds

The maintenance timer for air filter change is reset.

Please exchange air filter.
Hold to reset timer.



Slide two times to the left.

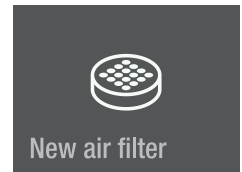

New air filter



Touch to exit.

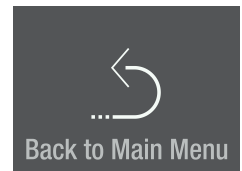

Back to Main Menu

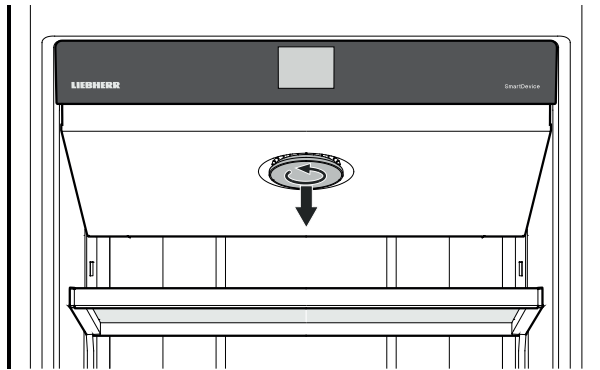

Turn the cover counterclockwise and remove.

Turn the air filter counterclockwise and remove.

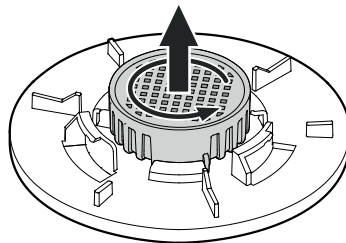

Insert the new air filter and turn clockwise until it snaps in.

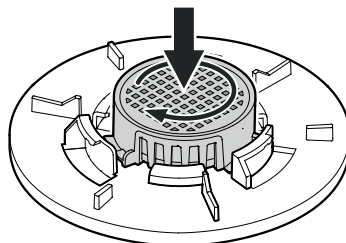

MAINTENANCE

Flush cleaning

When the water dispenser has not been used for one week or more, flush the pipeline.

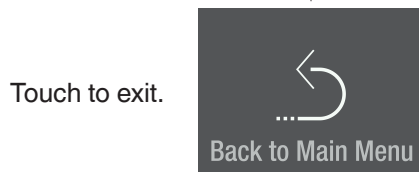
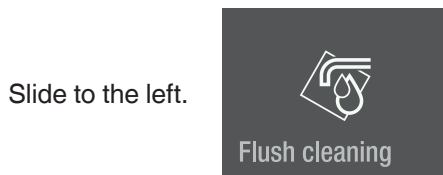
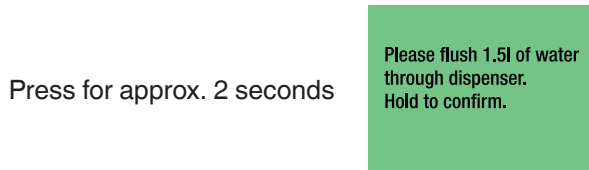
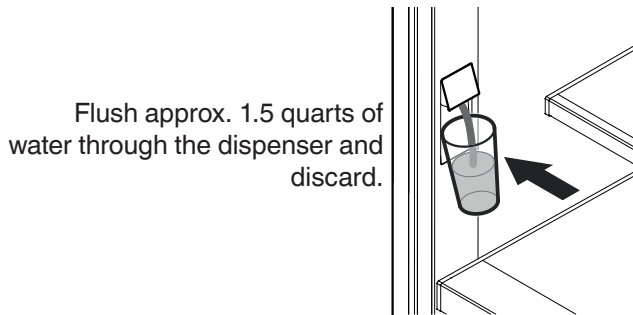
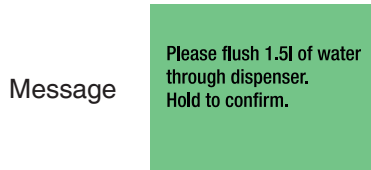

Cleaning the Dust Filter

Clean the dust filter in the toe kick area in at least the specified maintenance intervals.

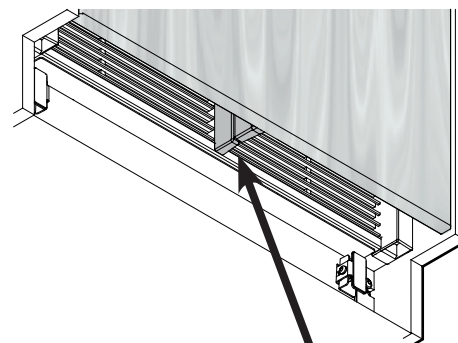
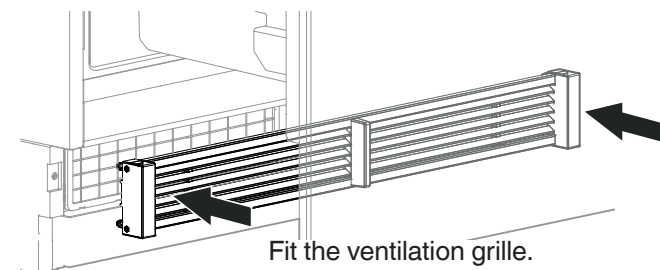
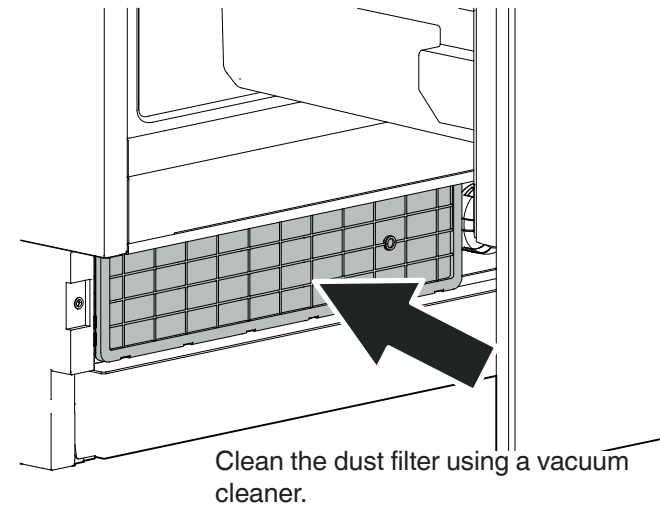
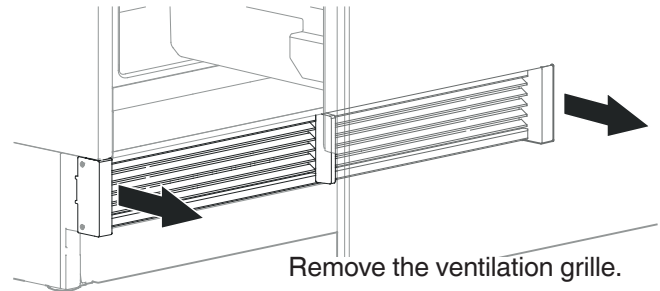

Check that there is no gap between the appliance air divider and the door air divider.

IMPORTANT

There will be a gap if the ventilation grille is fitted incorrectly.

Additional Functions

- BioFresh temperature adjustment
- BioFresh-Plus temperature adjustment
- Water pressure adjustment
- Heating control (MCB 36.2 only)
- Activating the defrost function manually
- Reset to factory setting
- DemoMode

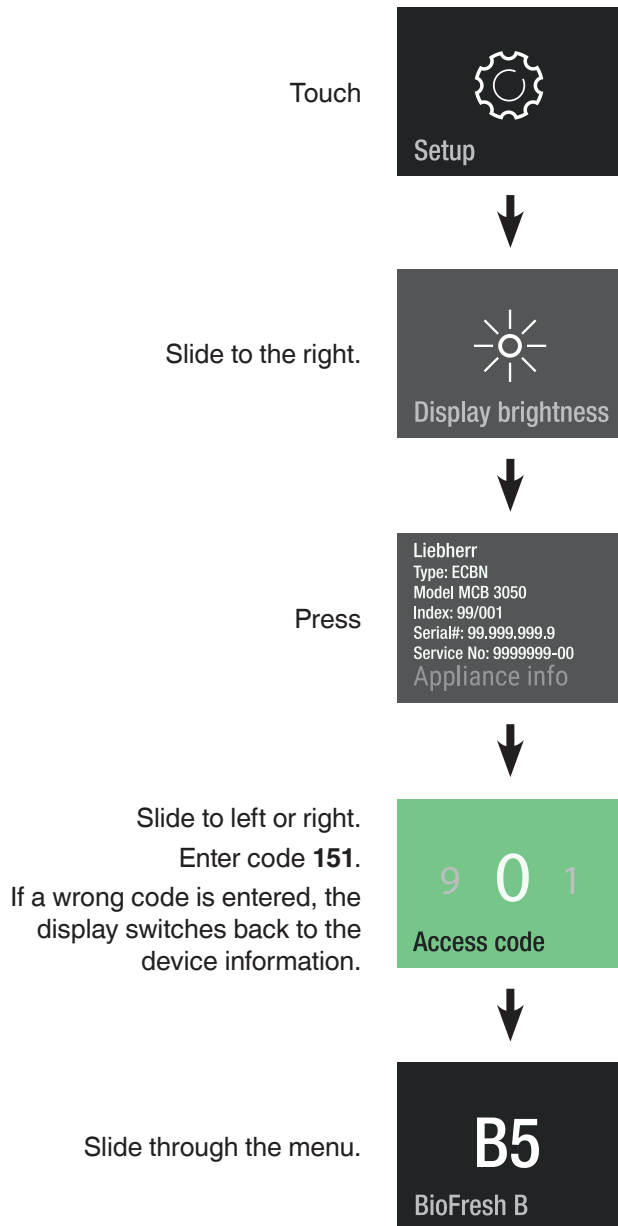

BioFresh temperature adjustment (Right-hand Side of the Drawer)

The temperature in the drawer is kept at a constant value of around 32°F. It can be adjusted to slightly warmer or colder.



For values B4 - B1, the temperature in the drawers can drop to below 32°F. Food may freeze.

IMPORTANT

Do not increase or reduce it by more than one step. Check the temperature in the BioFresh-Plus compartment during the next few days. If it is still not at the required temperature, increase or reduce the value again by one step.

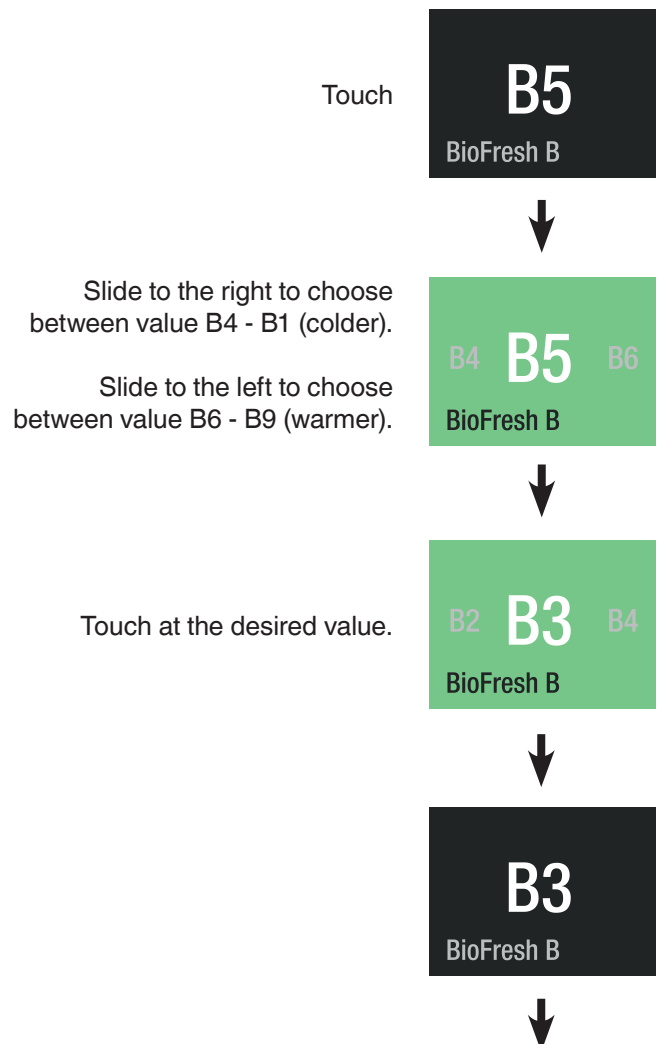

ADDITIONAL FUNCTIONS

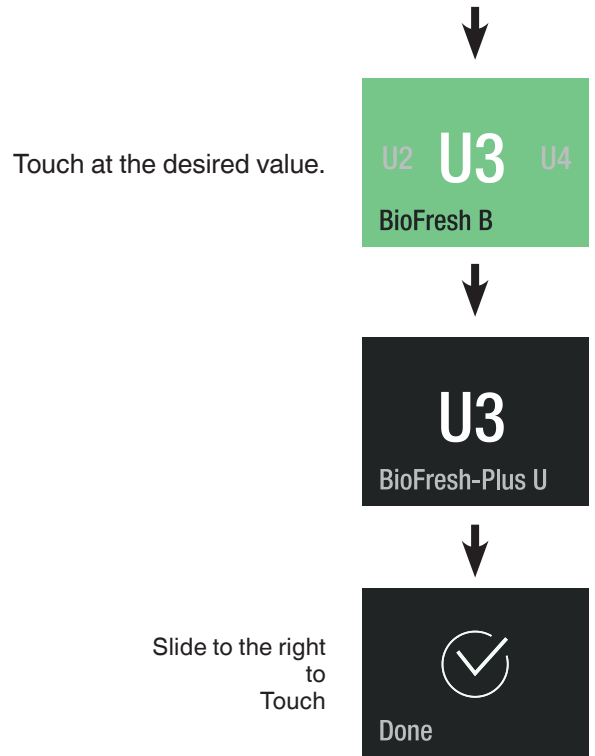
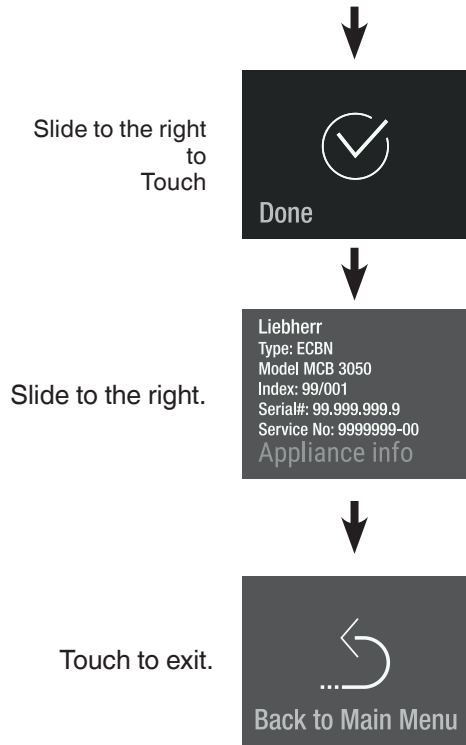

BioFresh-Plus temperature adjustment (Left-hand Side of the Drawer)

The temperature in the drawer can be set to 32°F or 28°F. Both fixed temperature settings can be adjusted respectively to slightly warmer or colder.

IMPORTANT

Do not increase or reduce it by more than one step. Check the temperature in the BioFresh-Plus compartment during the next few days. If it is still not at the required temperature, increase or reduce the value again by one step.

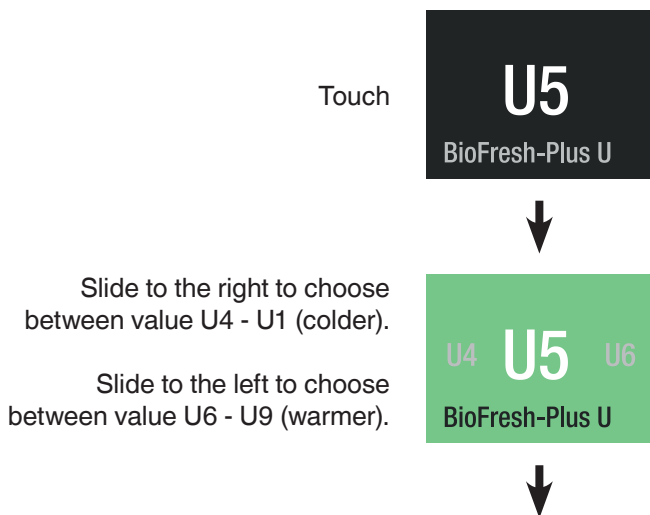
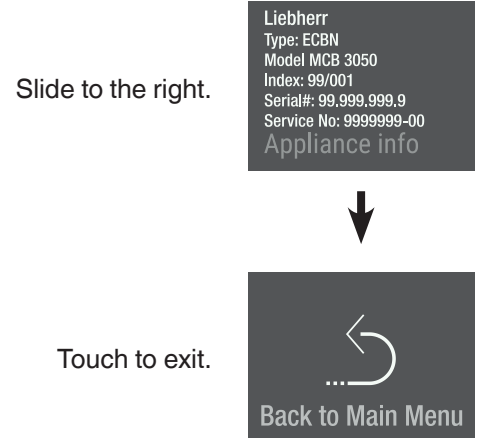

Water pressure

If the ice cubes produced by the ice maker are too small (the first few batches are always smaller), the inflowing water quantity can be adjusted.



IMPORTANT

Do not increase for more than one step. If the adjusted value is too high, the ice cube tray of the ice maker could overflow.

Check the ice cube size within the next days. If the ice cubes are still smaller than desired, increase the value for one step again.

Heating control (MCB 36.2 only)

If condensation forms on the seal on the refrigerator doors, this can be rectified by activating the seal heating system.

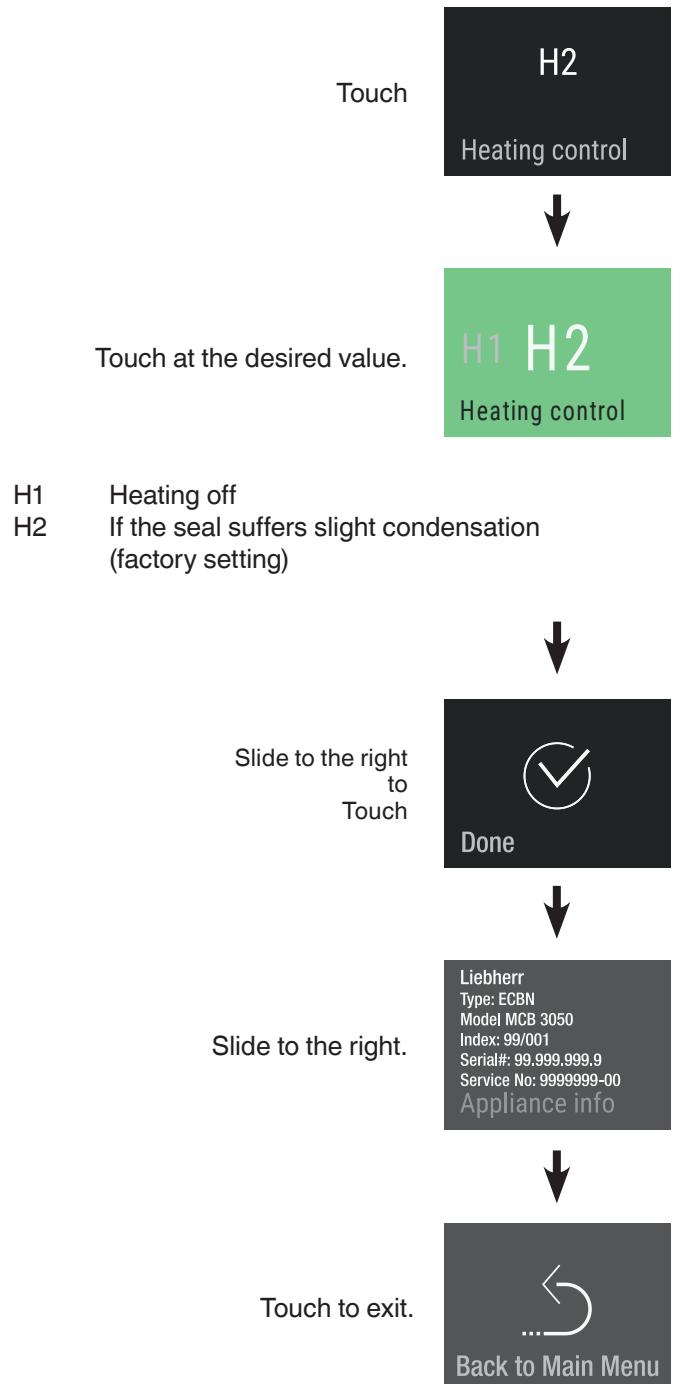

ADDITIONAL FUNCTIONS

Manual defrost

The appliance defrosts automatically. The defrost function can be activated manually for service applications.

Freezer Compartment

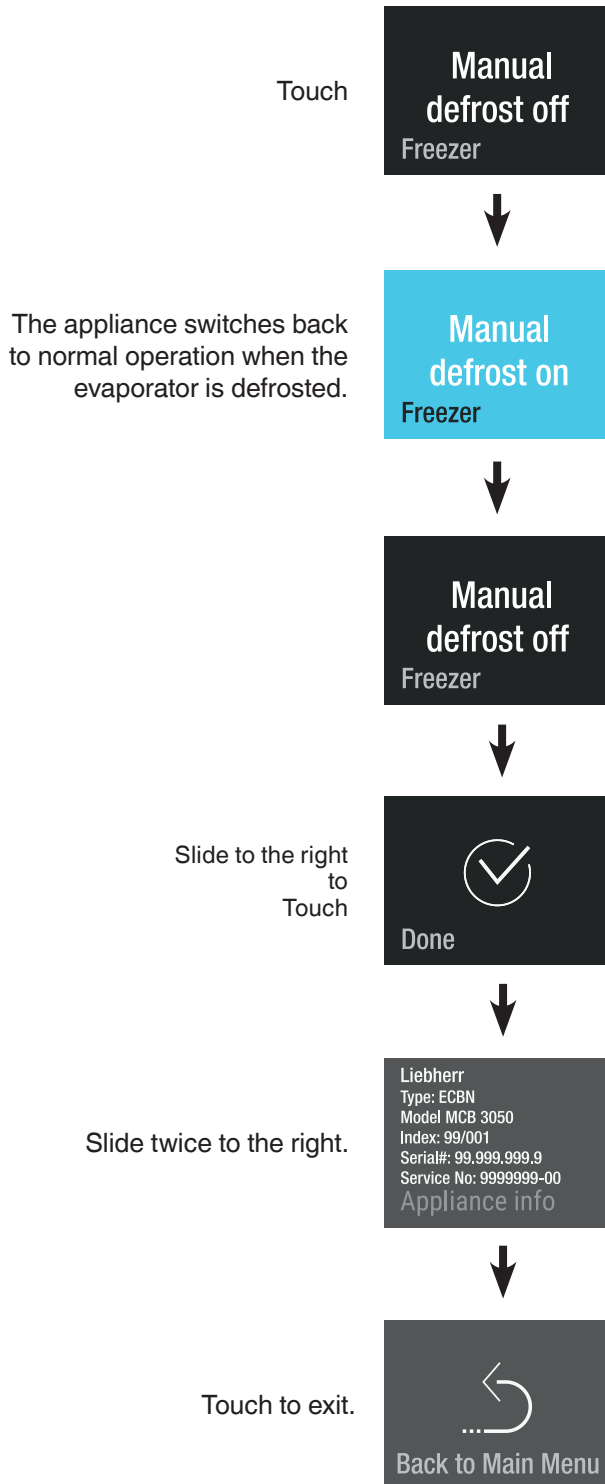

Refrigerator Compartment

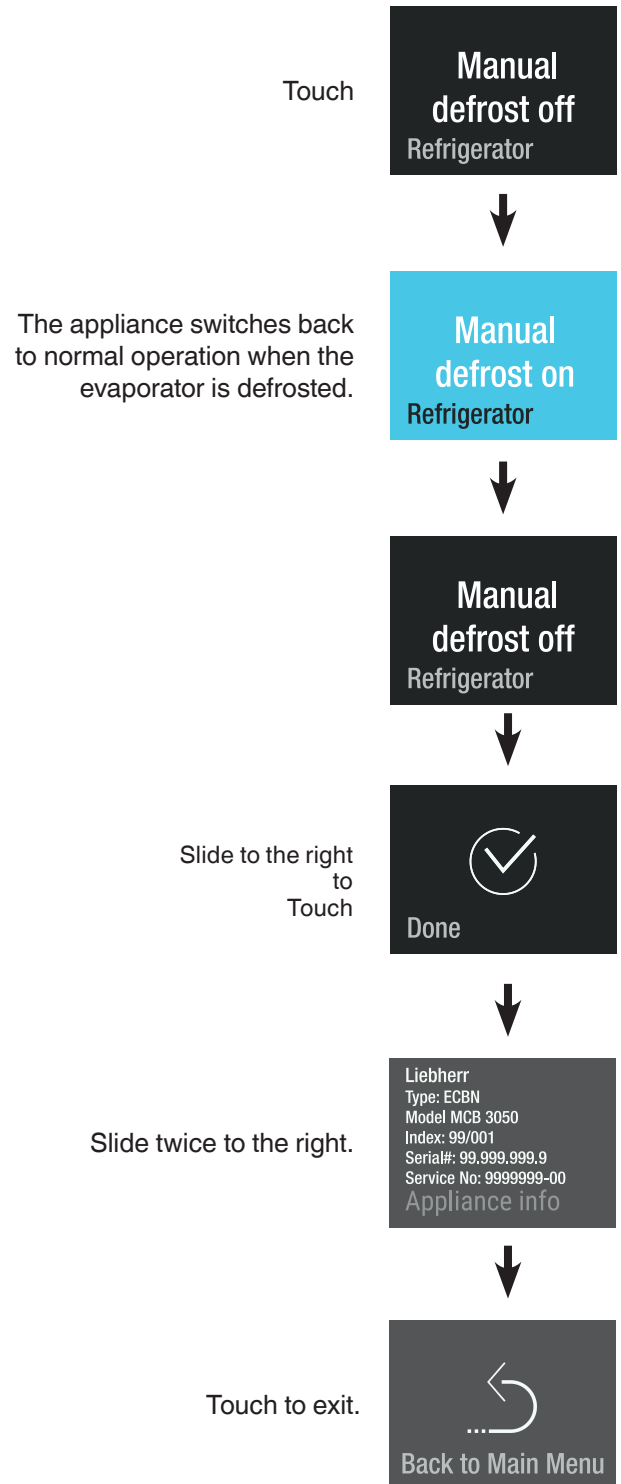

Reset

The electronic control can be reset to factory settings using this function.

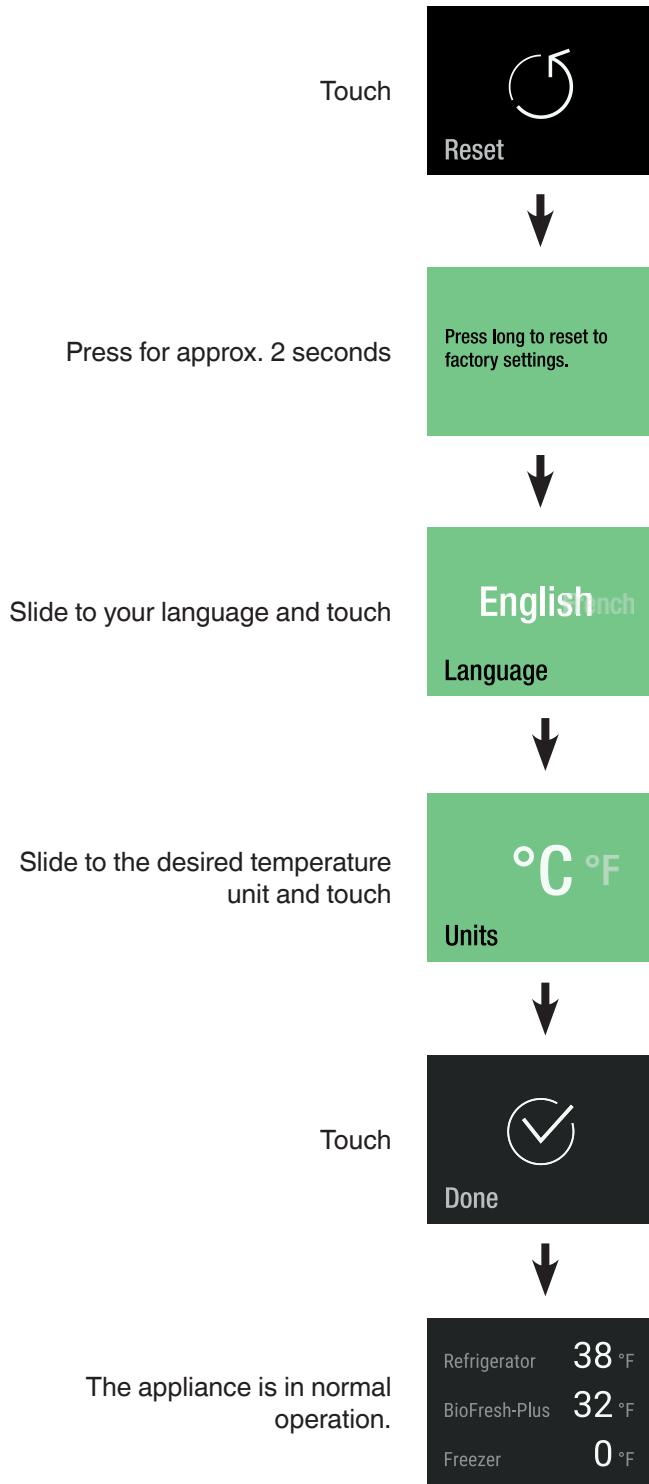

DemoMode

DemoMode can be activated for presenting the appliance at exhibitions or in showrooms as if it were in normal operating mode.

Activating DemoMode

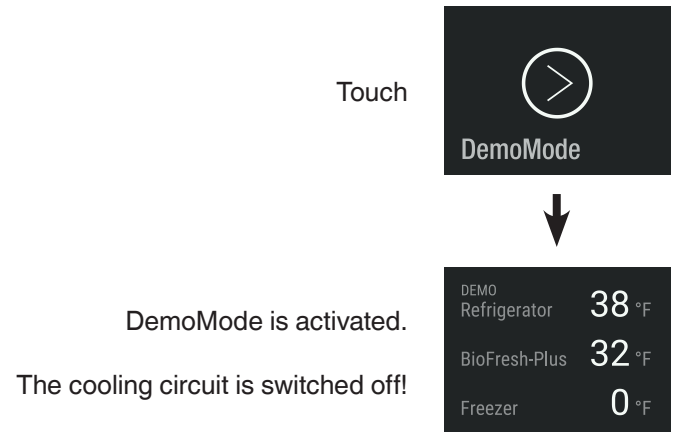

ADDITIONAL FUNCTIONS

Deactivating DemoMode

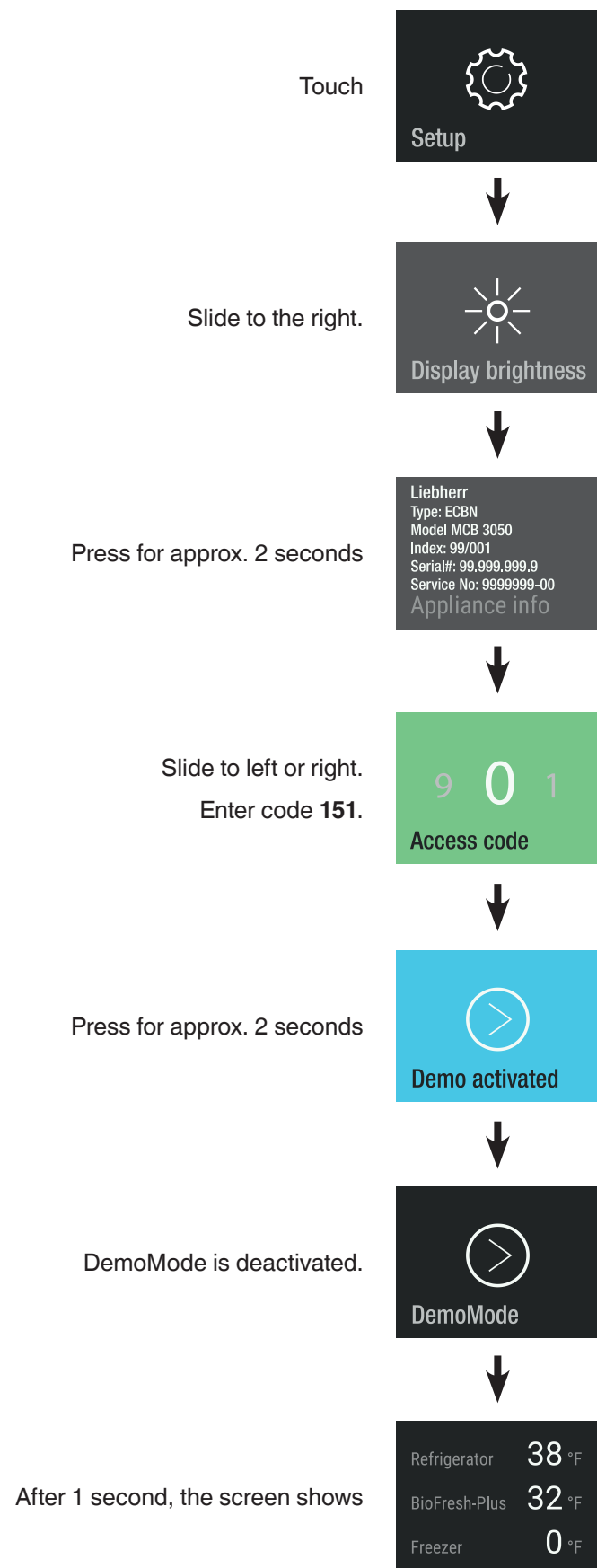

Troubleshooting

If a problem occurs during operation, check whether it is due to an operating error. Please note that even during the warranty period, some repair costs may be your responsibility.

You may be able to correct the following faults by checking the possible causes yourself:

Problem	Possible Cause and Remedy
Appliance does not work, display is off.	<ul style="list-style-type: none"> - Is the appliance turned on properly? - Is the power cord properly inserted in the outlet? - Is the circuit breaker or fuse in operating condition?
The interior light does not come on.	<ul style="list-style-type: none"> - Is the appliance turned on?
Motor seems to run too long.	<ul style="list-style-type: none"> - Is the ambient temperature too high? See „Important Safety Information“. - Has the appliance been opened too often or left open too long?
The temperature is not cold enough.	<ul style="list-style-type: none"> - Is the temperature setting correct? See „Setting the Temperature“. - Has an excessive amount of wine been placed in the appliance? - Does a separately installed thermometer show the correct reading? - Is the ventilation system working properly? - Is the appliance set up too close to a heat source?
The fans inside the appliance are running even though the fan function has been deactivated and the compressor (refrigeration unit) is idle.	<ul style="list-style-type: none"> - This is a normal operating state depending on the set interior temperature and ambient temperature at the place of installation.

Customer Service

If none of the above possible causes apply, and you can not rectify the fault yourself, contact your nearest customer service representative.

Indicate the type (1) of appliance, service number (2) and the appliance/serial number (3) as indicated on the model plate or in the device information in the setup menu of the electronic control system.

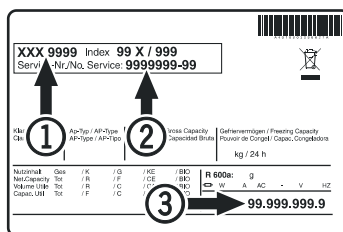

Appliance Information

Record this information when the appliance is installed.

Type Designation: _____

Service Number: _____

Appliance/Serial Number: _____

Date of Purchase: _____

Where Purchased: _____

The position of the model plate is shown in the section entitled „**Description of the Appliance**“.

For Service in the U.S.

Liebherr Service Center

Toll Free: **1-866-LIEBHER** or **1-866-543-2437**

Email: Service-appliances.us@liebherr.com

PlusOne Solutions, Inc.

3501 Quadrangle Blvd, Suite 120

Orlando, FL 32817

For Service in Canada

Liebherr Service Center

Toll Free: **1-888-LIEBHER** or **1-888-543-2437**

www.euro-parts.ca

EURO-PARTS CANADA

39822 Belgrave Road

Belgrave, Ontario, N0G 1E0

Phone: (519) 357-3320

Fax: (519) 357-1326



www.liebherr-appliances.com