

Datos Técnicos

Grúa de celosía sobre cadenas

LR 1200

Litronic®

- Elevación

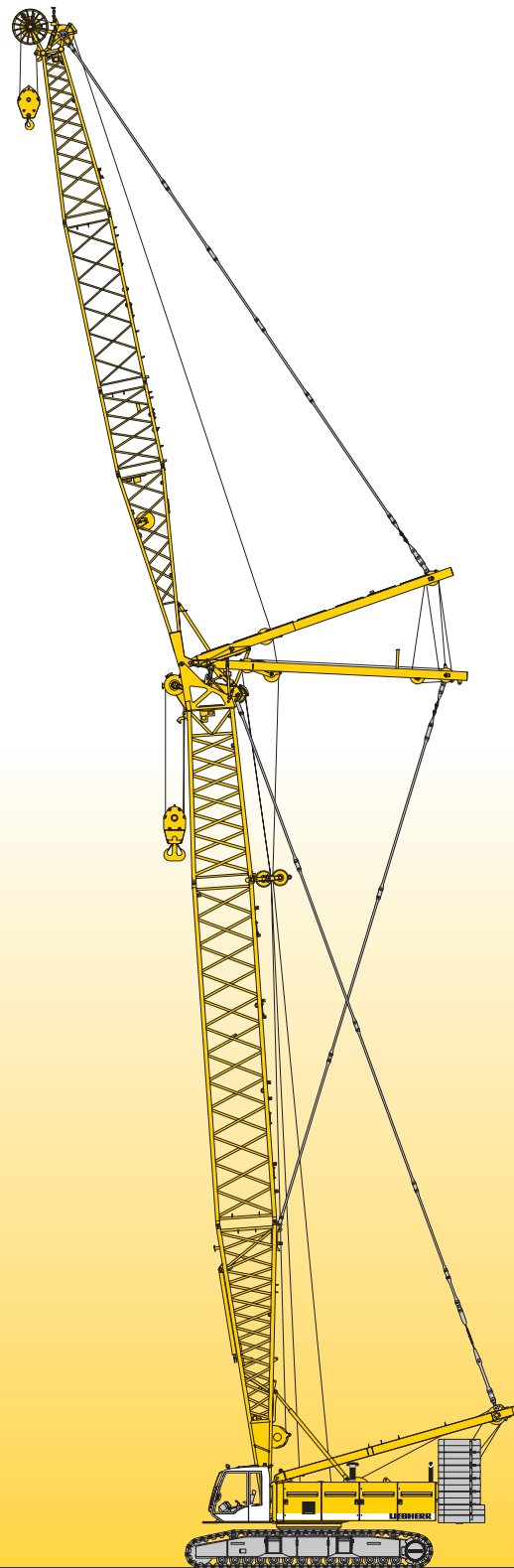

LIEBHERR

Dimensiones

Máquina base con chasis inferior

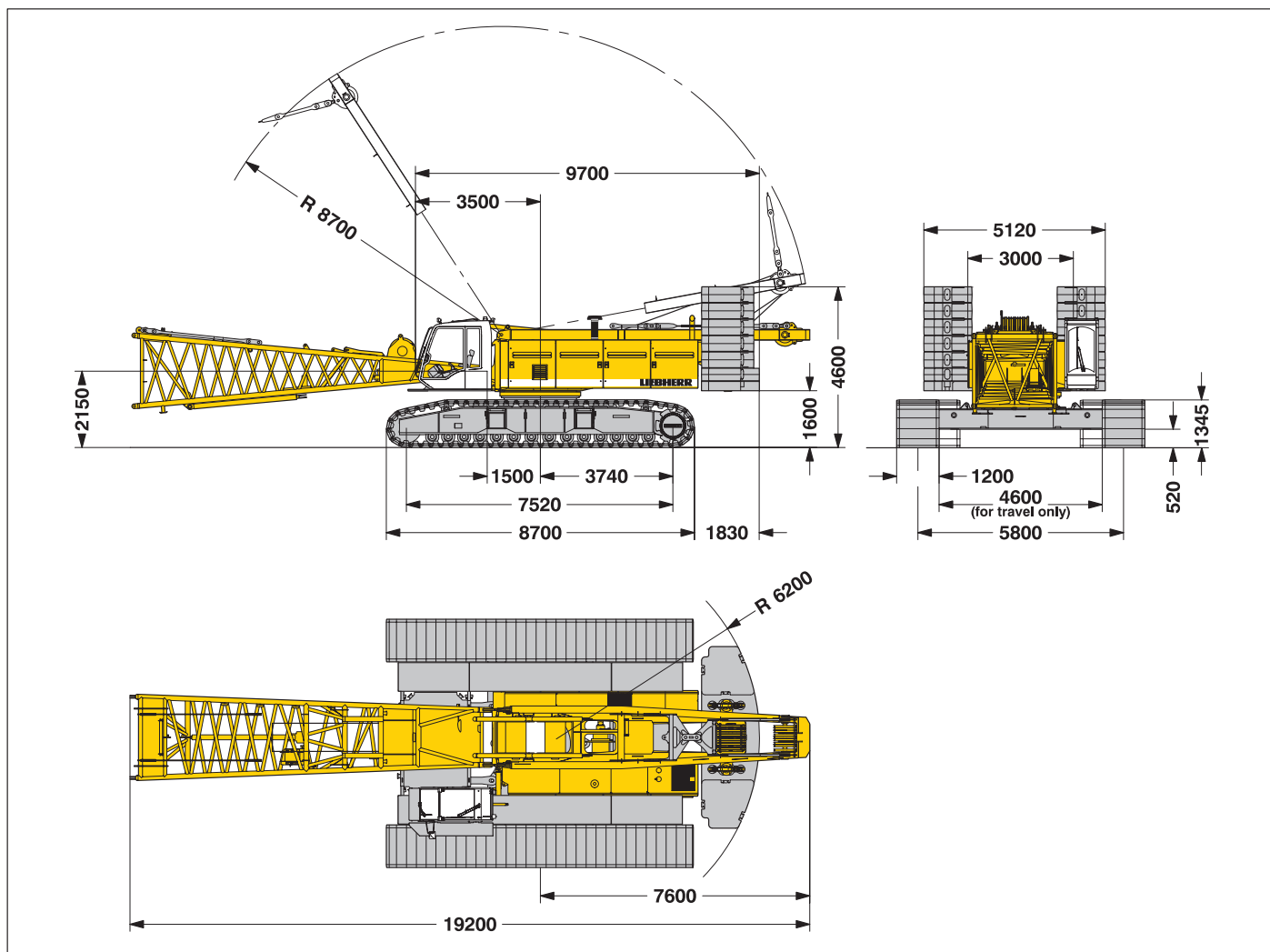

Peso operacional

El peso operacional incluye la máquina base con cadenas, 2 cabrestantes principales de 120 kN y una pluma principal de 20 m, que se compone de un caballete, pie de pluma (10 m), cabeza de pluma (7 m), tramo de pluma (3 m), contrapeso base (81 t), contrapeso central 36 t, y un gancho de 250 t de capacidad.

Peso total _____ aprox. 210.0 t

Presión sobre el suelo

Presión sobre el suelo _____ 1.16 kg/cm²

Equipo de trabajo

Pluma principal (Nº 2320.xx) longitud máxima _____ 89 m
De largo alcance (Nº 2320.xx y 1916.xx) _____ 117 m
Plumín abatible (Nº 1916.xx) longitud máxima _____ 95 m
Combinación máx. _____ con pluma de 53 m y plumín abatible de 95 m
Plumín fijo (Nº 1008.xx) _____ 11 m – 26 m
Plumín auxiliar con capacidad de 24 t (opcional 36 t)

Observaciones

1. Las mencionadas capacidades de carga son válidas para trabajos de elevación (corresponden según clasificación de grúas F.E.M. 1001, grupo de grúas A1).
2. La grúa debe estar situada sobre un terreno horizontal y firme.
3. Los pesos de los implementos de elevación (tales como cables de elevación, ganchos, cuñeros etc) se tienen que deducir de los valores de carga.
4. Equipos adicionales montados en la pluma (tales como pasarelas), plumín auxiliar se tienen que deducir de los valores de carga.
5. Para conocer las velocidades máximas de viento durante el trabajo con la grúa, consultar la introducción de la tabla de cargas.
6. El radio de trabajo se mide desde el centro de la corona.
7. Las capacidades de carga están indicadas en toneladas y son válidas para 360 grados de giro.
8. El cálculo de estabilidad bajo la carga está basado en DIN 15019 / parte 2 / tabla 1/ ISO 4305 Tabla 1 + 2, valor vuelco 4°.
9. Las estructuras están calculadas según F.E.M 1.001 – 1998 (prEN 13001 / T2 / 1997)

Dimensiones y pesos de transporte

Máquina base y pluma (N° 2320.xx)

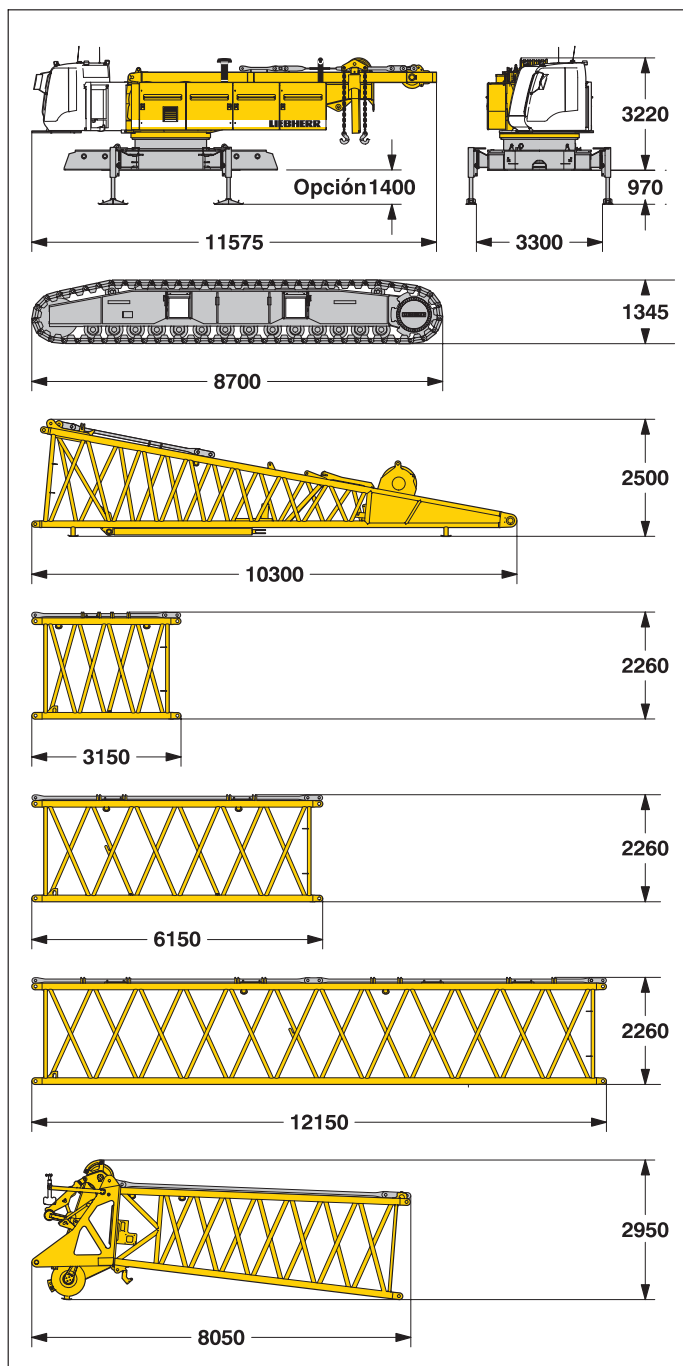

Máquina base

Con pie de pluma (N° 2320.xx), caballete, 2 cabestrantes de 120 kN sin cables de carga, sin contrapeso base y cadenas.

Ancho	mm	3000
Peso	kg	38100

Cadenas

2x

Tejas	mm	1200
Ancho	mm	1200
Peso	kg	19800

Pie de pluma (N° 2320.xx)

Ancho	mm	2420
Peso*	kg	5300

Tramo de pluma (N° 2320.xx)

3 m

Ancho	mm	2420
Peso*	kg	920

Tramo de pluma (N° 2320.xx)

6 m

Ancho	mm	2420
Peso*	kg	1285

Tramo de pluma (N° 2320.xx)

12 m

Ancho	mm	2420
Peso*	kg	2360

Cabeza de pluma (N° 2320.xx)

Ancho	mm	2420
Peso*	kg	4300

Opción de transporte

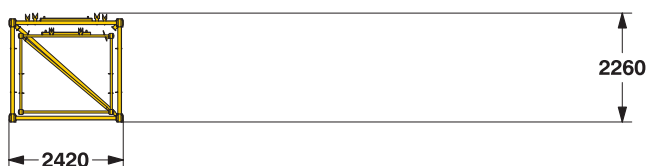

*) Incluye tirantes

Opción de transporte de pluma

N° 2320.xx/1916.xxx	m	12 / 12	6 / 6	3 / 3
Longitud	mm	12250	6250	3250
Peso*	kg	3610	1975	1470

Dimensiones y pesos de transporte

Plumín abatible (N° 1916.xx)

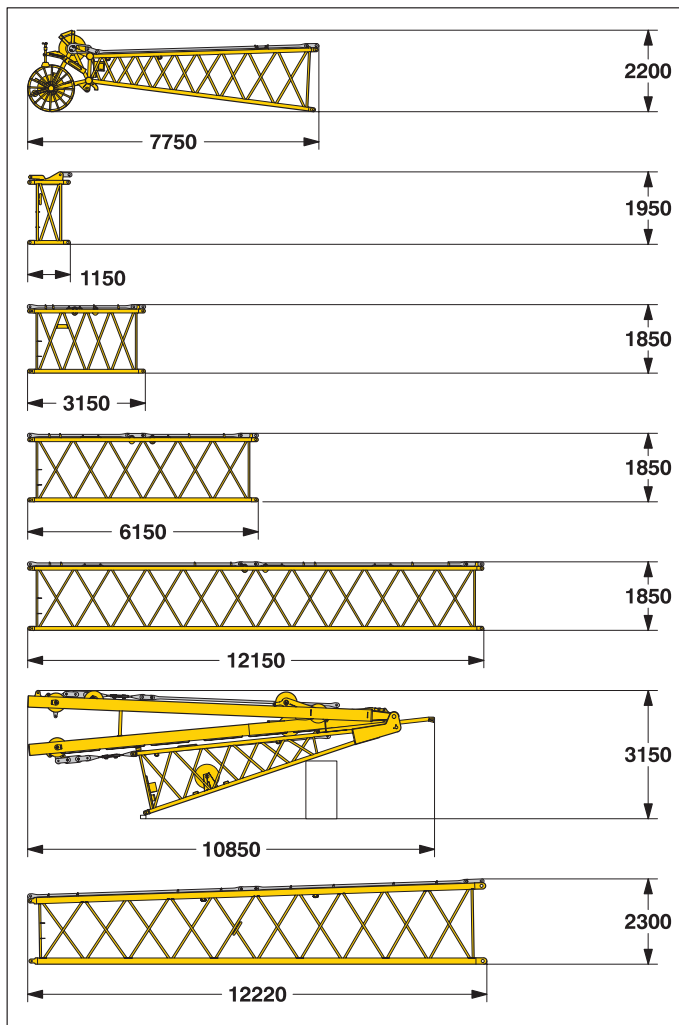

Cabeza de plumín abatible (N° 1916.xx)

Ancho	mm	2050
Peso*	kg	1550

Tramo adaptador para pluma ligera (N° 1916.xx) **1 m**

Ancho	mm	2050
Peso*	kg	457

Tramo plumín abatible (N° 1916.xx) **3 m**

Ancho	mm	2050
Peso*	kg	550

Tramo plumín abatible (N° 1916.xx) **6 m**

Ancho	mm	2050
Peso*	kg	690

Tramo plumín abatible (N° 1916.xx) **12 m**

Ancho	mm	2050
Peso*	kg	1250

Pie de plumín abatible con caballete (N° 1916.xx)

Ancho	mm	2050
Peso*	kg	6400

Tramo de pluma cónica (N° 2320/1916.xx) **12 m**

Ancho	mm	2420
Peso*	kg	2635

Plumín fijo (N° 1008.xx)

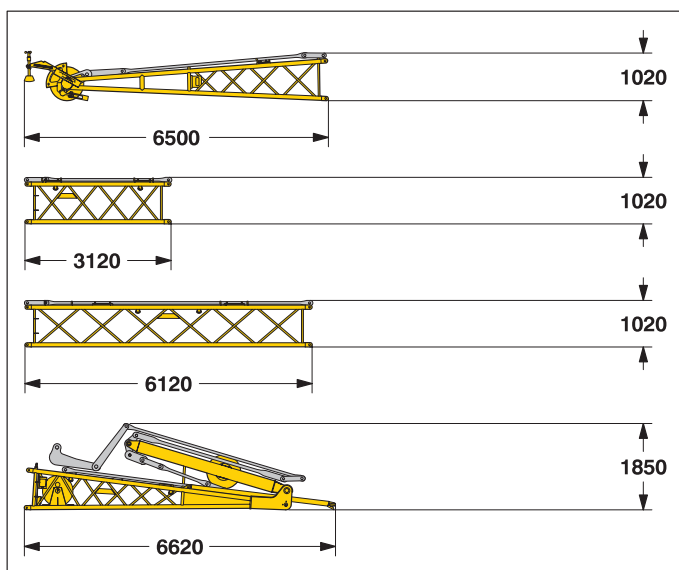

Cabeza de plumín fijo (N° 1008.xx)

Ancho	mm	1140
Peso*	kg	935

Tramo plumín fijo (N° 1008.xx) **3 m**

Ancho	mm	1100
Peso*	kg	300

Tramo plumín fijo (N° 1008.xx) **6 m**

Ancho	mm	1100
Peso*	kg	460

Pie de plumín fijo con caballete (N° 1008.xx)

Ancho	mm	1500
Peso*	kg	1950

*) Incluye tirantes

Dimensiones y pesos de transporte

Contrapeso

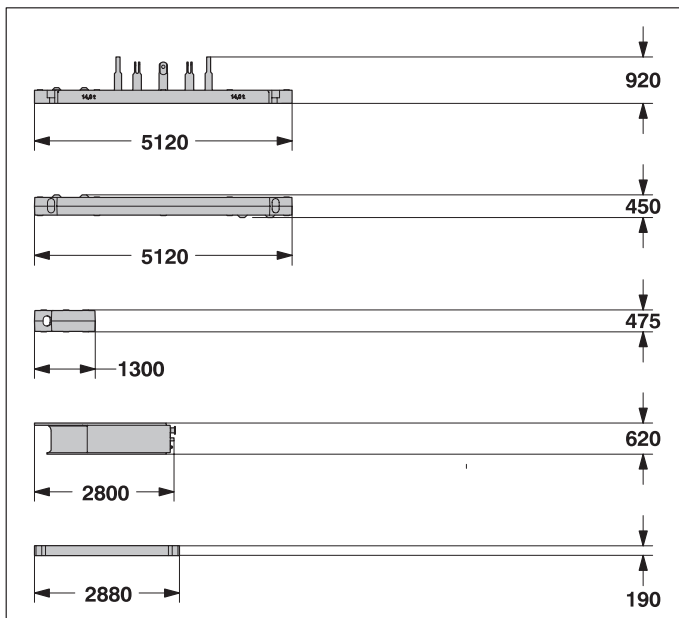

Contrapeso trasero 1x

1x

Ancho	mm	1660
Peso	kg	14500

Contrapeso trasero 1x

1x

Ancho	mm	1660
Peso	kg	16300

Contrapeso trasero 10x

10x

Ancho	mm	1360
Peso	kg	5100

Contrapeso central 2x

2x

Ancho	mm	3340
Peso	kg	9800

Contrapeso central 2x

2x

Ancho	mm	2050
Peso	kg	8300

Punto de elevación intermedio en el plumín (opción)

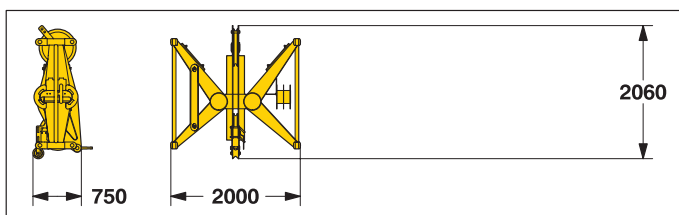

Tramo (N° 1916.xx)

0.5 m

Ancho	mm	750
Peso	kg	715

Ganchos

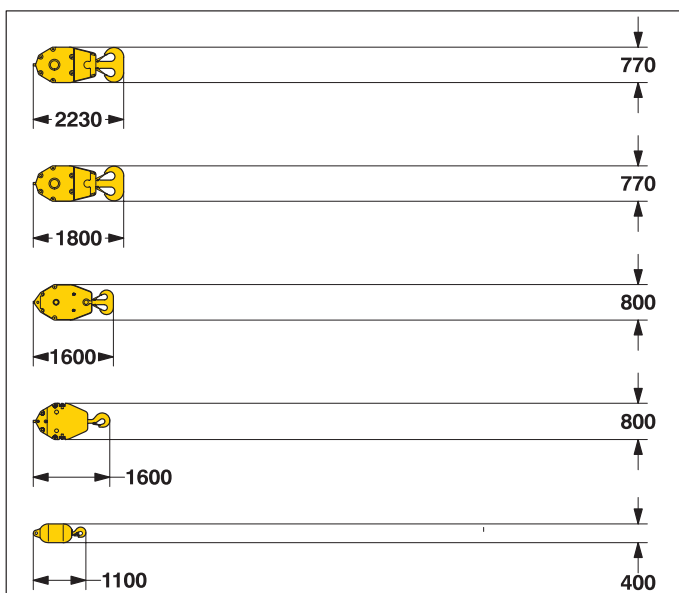

Gancho 250 t - 11 poleas

Ancho	mm	1030 — 1250
Peso	kg	2300 — 3200

Gancho 100 t - 5 poleas

Ancho	mm	540 — 640 — 770
Peso	kg	1300 — 1800 — 2300

Gancho 80 t - 3 poleas

Ancho	mm	560
Peso	kg	2000

Gancho 40 t - 1 polea

Ancho	mm	300 — 400 — 500
Peso	kg	700 — 1100 — 1500

Gancho simple 12 t

Ancho	mm	400
Peso	kg	600

Descripción técnica



Motor

Potencia controlada de acuerdo a la norma ISO 9249, 240 kW (326 caballos) a 2000 r. p.m.
Tipo de motor — Liebherr D 926 TI-E
Capacidad de tanque — 800 l de capacidad con indicador continuo de nivel y de reserva.
De acuerdo con EPA CARB II/TIER II/ y 97/68 EC TIER II OFF-ROAD.



Sistema hidráulico

La bomba doble de desplazamiento axial y caudal variable permite realizar todos los movimientos de forma simultánea. Para reducir picos de presión hidráulica se incorpora una válvula de corte en la bomba. Todos los filtros están controlados electrónicamente en el monitor.
Existe la posibilidad de utilizar aceites sintéticos ecológicos (biodegradables).
Presión — máx. 350 bar
Capacidad de tanque — 650 l



Cabestrante de plumín abatible

Tiro del cable — máx. 105 kN
Diámetro del cable — 20 mm
Tiempo de subida/bajada de 15° a 78° — 51 s



Cabestrante de pluma

Tiro del cable — máx. 216 kN
Diámetro del cable — 24 mm
Tiempo de subida/bajada de 15° a 86° — 130 s



Mecanismo de giro

Corona de giro de rodamiento interno y dientes exteriores, accionado por un reductor con motor hidráulico de pistones axiales, frenos multi-disco accionados hidráulicamente, engranaje planetario y piñon.
A través del giro libre se reduce el desgaste al mínimo. Como alternativa se puede controlar la velocidad de giro con los joysticks y se cerrará el freno de parada de discos múltiples automáticamente en la posición cero.
Velocidad de giro: 0 – 3 r.p.m., regulable sin escalonamientos.



Cabestrantes principales

Tiro de cable (en la 1ª capa) — máx. 175 kN
Tiro de cable (en la 7ª capa) — 120 kN
Diámetro del cable — 26 mm
Diámetro del tambor — 580 mm
Velocidad cable m/min — 0 – 136
Longitud de cable en 7 capas — 489 m
Los cabestrantes destacan por su diseño compacto y su facilidad de ensamblaje. Consisten de un engranaje planetario interno, bañado en aceite y de mantenimiento mínimo. La carga se sostiene por el sistema hidráulico, además de un factor de seguridad adicional, con un freno de discos múltiples (freno de parada).
Para los cabestrantes se utiliza motores de control de alta presión y caudal variable. Este sistema dispone de sensores que automáticamente ajustan del caudal de aceite para alcanzar la máxima velocidad dependiendo de la carga suspendida.
Opción: Cabestrantes con caída libre
En el cabestrante con caída libre se realiza la función de freno y de embrague solo con el freno de trabajo. Este freno es un freno de discos múltiples de diseño compacto, de bajo desgaste y sin necesidad de mantenimiento.



Mecanismo de traslación

El mecanismo de traslación se realiza a través de un motor de pistones axiales, frenos de discos múltiples de bajo mantenimiento y dos tensores hidráulicos de cadenas.
Tejas planas — 1200mm
Velocidad de traslación — 0 – 1.6 km/h



Sistema de control electrónico

El sistema de control está diseñado y fabricado por Liebherr para trabajar en las obras y en condiciones medio ambientales más duras tales como cambios bruscos de temperatura, alta humedad, vibraciones e interferencias eléctrico-magnéticas.
Todos los datos relevantes de la máquina se muestran en un monitor de alta resolución. Información estándar se visualiza a través de símbolos gráficos, los mensajes de error aparecen en forma de mensajes de texto claros y concisos. (disponible en más de diez idiomas diferentes)
Las grúas vienen equipadas con un control proporcional sin escalas, que permiten realizar todos los movimientos posibles simultáneamente.
Un sistema de emergencia, que permite un manejo limitado en casos de urgencia, está incluido en el suministro de la grúa.
El manejo se lleva a cabo a través de dos joysticks multi-direccionales, el derecho para el cabestrante I y la pluma y el izquierdo para el cabestrante II y el giro.
Las cadenas se activan por medio de unos pedales centrales que además llevan unas palancas de mano.
Opción:
Mando doble T bi-direccional para un manejo simultáneo de la pluma y el plumín.



Emisión de sonidos

La emisión de sonidos corresponde a la directiva 2000/14 de la normativa CE de emisión de sonidos en el exterior.

Configuraciones de pluma



Sistema de auto montaje

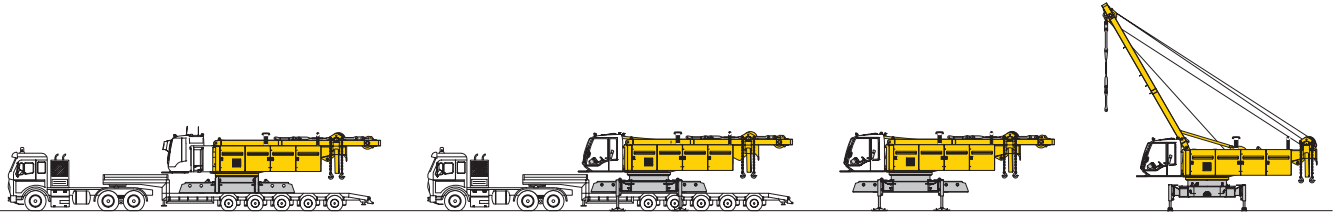

Descarga de la máquina base

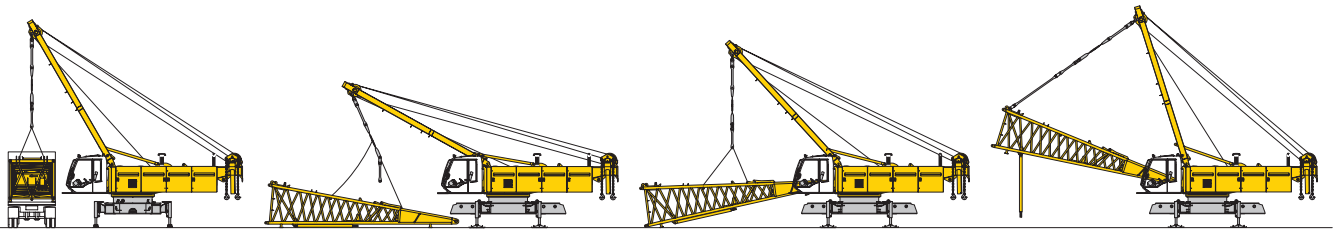

Descarga y montaje del pie de pluma

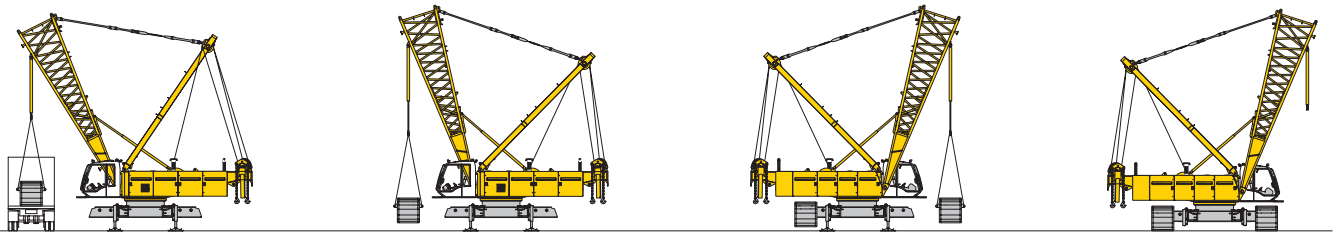

Descarga y montaje de las cadenas

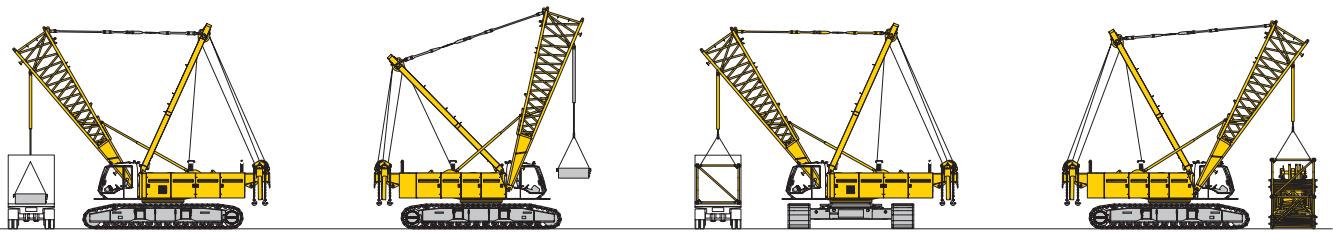

Descarga y montaje del contrapeso central

Descarga y montaje de la pluma

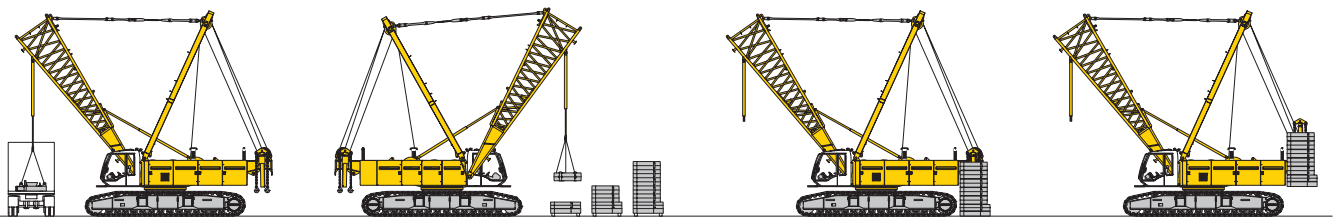

Descarga y montaje del contrapeso

Elevación de la pluma a posición de trabajo

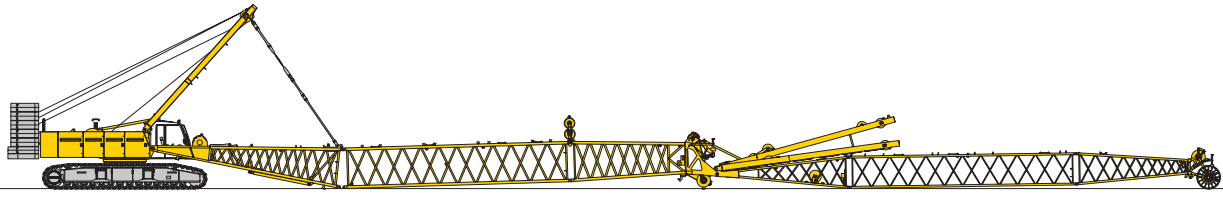

Montaje de la pluma

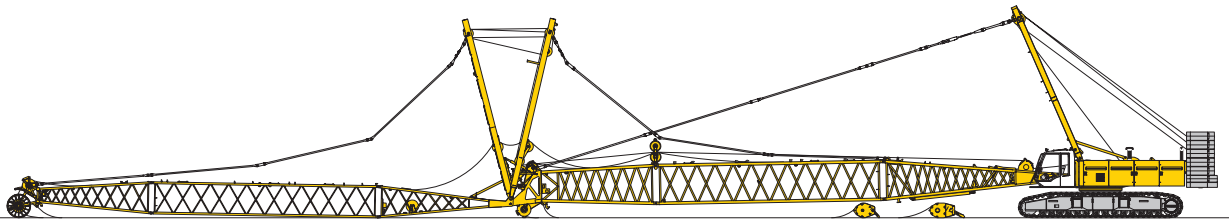

Montaje de los cables de elevación de la pluma principal y del plumín abatible



Elevación de la pluma principal y del plumín abatible

Posición de trabajo

Tabla de cargas para pluma principal (N° 2320.xx) 81 t contrapeso y 36 t contrapeso central

Capacidades de carga indicadas en toneladas para pluma con longitud de (20 m – 89 m) – con cabestrantes de 120 kN

Radio (m)	Longitud pluma en (m)												
	20	26	32	38	44	50	56	62	68	74	80	86	89
6.2	t	t	t	t	t	90.6	t	t	t	t	t	t	t
7				129.1	106.8	89.2	79.4	63.5					
8			125.3	117.1	99.9	83.2	75.7	62.9	51.7	44.6			
9	119.2	116.7	110.3	103.8	88.0	77.8	71.6	59.8	50.0	44.2	37.0	30.0	26.4
10	107.3	104.1	97.8	91.6	84.4	72.6	68.1	57.2	47.9	42.6	36.0	29.8	26.4
12	86.8	84.7	80.5	76.7	73.1	65.0	63.4	53.2	43.7	40.1	33.3	27.8	24.8
14	69.9	69.7	67.7	65.0	62.2	54.5	57.1	50.3	40.4	37.6	31.2	26.1	22.8
16	58.2	58.2	58.2	56.2	53.9	51.1	49.7	45.5	37.9	35.0	29.4	24.4	21.3
18	49.6	49.6	49.6	49.3	46.3	45.6	43.8	42.1	33.3	33.5	28.0	23.4	20.1
20	42.9	43.1	43.0	42.8	42.2	40.6	39.0	37.5	31.7	31.7	26.4	22.6	19.1
26		30.0	30.1	29.9	29.6	29.3	28.8	27.7	26.6	25.5	22.3	19.9	16.5
32			22.4	22.3	22.1	21.7	21.4	21.1	20.4	19.5	18.7	17.4	14.9
38				17.2	17.1	16.7	16.4	16.1	15.7	15.3	14.5	13.7	13.4
44					13.4	13.2	12.9	12.5	12.2	11.8	11.3	10.7	10.4
50						10.5	10.3	9.9	9.6	9.2	8.8	8.3	8.0
55							8.5	8.1	7.8	7.4	7.1	6.6	6.4
60								6.7	6.3	6.0	5.6	5.2	5.0
65									5.1	4.7	4.4	4.0	3.8
70										3.7	3.3	2.9	2.8
75											2.4	2.0	

Tabla de cargas para pluma principal (N° 2320.xx) 70.8 t contrapeso y 36 t contrapeso central

Capacidades de carga indicadas en toneladas para pluma con longitud de (20 m – 86 m) – con cabestrantes de 120 kN

Radio (m)	Longitud pluma en (m)												
	20	26	32	38	44	50	56	62	68	74	80	86	
4.1	220.0												
5	216.5	162.7	153.5										
6	190.7	158.9	150.6	139.9	113.7								
7	150.8	143.7	132.7	123.1	106.8	89.2	79.4	63.5					
8	132.7	122.3	114.7	107.3	99.9	83.2	75.7	62.9	51.7	44.6			
9	111.8	107.5	100.9	94.9	88.0	77.8	71.6	59.8	50.0	44.2	37.0	30.0	
10	101.3	95.2	89.9	84.9	80.4	72.6	68.1	57.2	47.9	42.6	36.0	29.8	
12	79.3	77.3	73.5	69.9	66.7	63.5	60.6	53.2	43.7	40.1	33.3	27.8	
14	63.7	63.8	62.0	59.2	56.6	54.2	51.9	49.6	40.4	37.6	31.2	26.1	
16	53.0	53.0	53.0	51.1	49.0	47.0	45.1	43.2	37.9	35.0	29.4	24.4	
18	45.1	45.1	45.1	44.8	43.0	41.3	39.7	38.0	33.3	33.5	28.0	23.4	
20	38.9	39.1	39.0	38.8	38.2	36.7	35.3	33.8	31.7	31.2	26.4	22.6	
26		27.1	27.2	26.9	26.7	26.4	25.9	24.8	23.8	22.7	21.7	19.9	
32			20.1	20.0	19.7	19.4	19.1	18.7	18.1	17.2	16.4	15.5	
38				15.3	15.1	14.8	14.5	14.1	13.8	13.3	12.5	11.8	
44					11.8	11.6	11.3	10.9	10.6	10.2	9.7	9.0	
50						9.1	8.8	8.5	8.1	7.7	7.4	6.8	
55							7.2	6.8	6.5	6.1	5.8	5.3	
60								5.5	5.2	4.8	4.4	4.0	
65									4.0	3.6	3.3	2.9	
70										2.7	2.3		

Esta tabla de cargas sirve únicamente como información. Para trabajos de elevación consultar la tabla de carga de la cabina o el manual.

Pluma - L de largo alcance (N° 2320 / 1916.xx) **66 m - 117 m** Radio de trabajo 86° - 15°

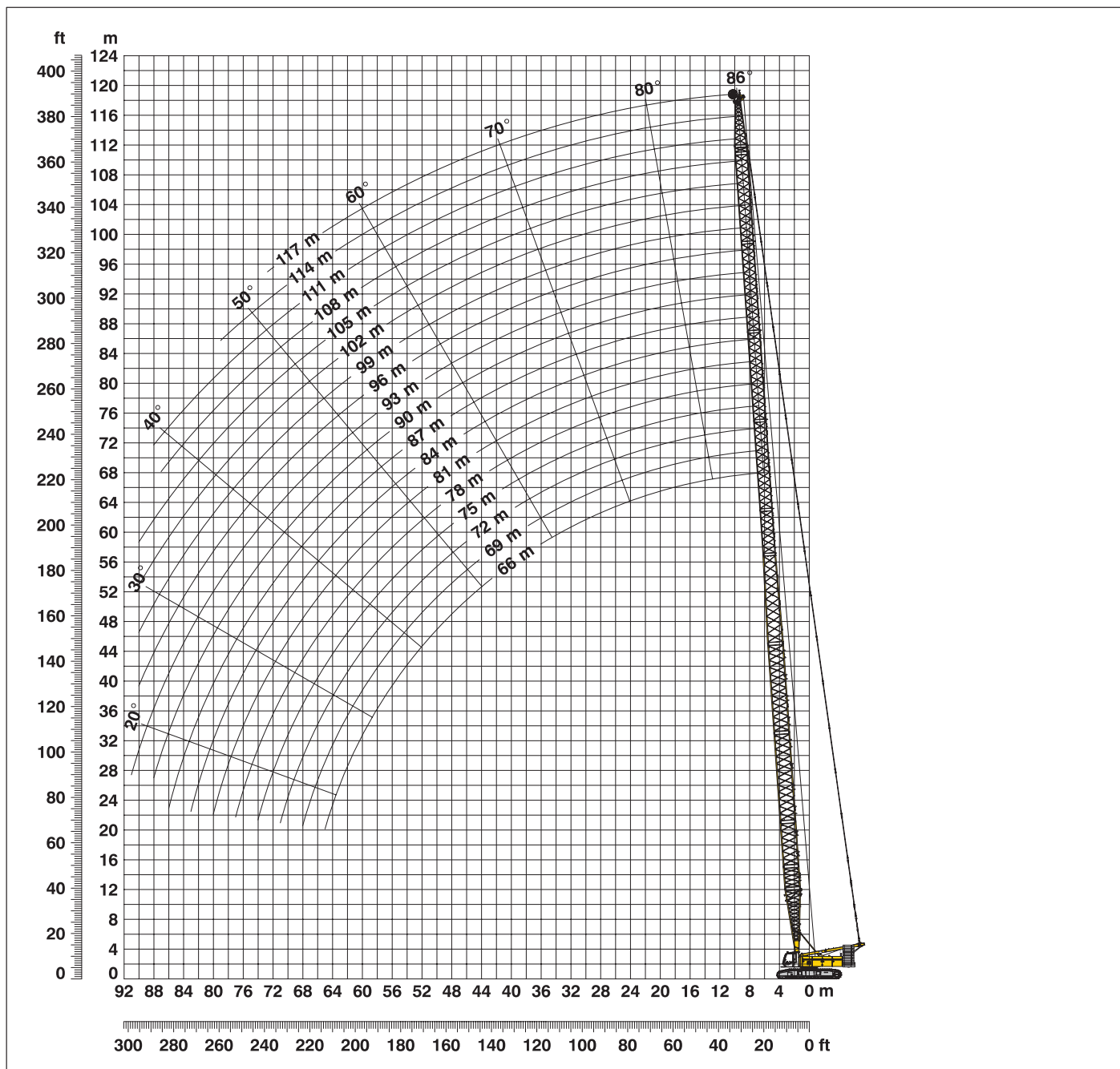

Configuración de pluma L con pluma principal de 43 m (N° 2320.xx / N° 1916.xx)

Configuración para longitud de pluma (74.1 m – 119.1 m)

	Longitud	Número de tramos de pluma y de plumín abatible																	
		1	1	1	1	1	1	1	1	1	1	1	1	1	1	1	1	1	
Pie de pluma	10.0 m	1	1	1	1	1	1	1	1	1	1	1	1	1	1	1	1		
Tramo pluma	3.0 m	1	1	1	1	1	1	1	1	1	1	1	1	1	1	1	1		
Tramo pluma	6.0 m	1	1	1	1	1	1	1	1	1	1	1	1	1	1	1	1		
Tramo pluma	12.0 m	2	2	2	2	2	2	2	2	2	2	2	2	2	2	2	2		
Tramo cónico	12.0 m	1	1	1	1	1	1	1	1	1	1	1	1	1	1	1	1		
Tramo plumín abatible	3.0 m	1		1		1		1		1		1		1		1			
Tramo plumín abatible	6.0 m		1	1		1	1		1	1		1	1		1	1			
Tramo plumín abatible	12.0 m				1	1	1	1	2	2	2	2	3	3	3	3	4		
Cabeza plumín abatible	8.0 m	1	1	1	1	1	1	1	1	1	1	1	1	1	1	1	1		
Longitud máx. pluma L (m)		66	69	72	75	78	81	84	87	90	93	96	99	102	105	108	111	114	117

Tablas de cargas - pluma - L (N° 2320 /1916.xx)

Pluma principal 43 m

Capacidad en toneladas: Contrapeso de 81 t y contrapeso central de 36 t						
Radio (m)	Longitud de pluma - L en (m)					
	66	75	90	99	108	117
6.7	54.3					
8	53.6	39.0				
9	52.5	38.2	24.5	17.4		
10	51.6	36.7	23.4	17.3	11.6	
12	48.0	33.6	21.6	16.0	11.3	7.5
14	43.7	31.3	20.0	14.9	10.6	7.1
16	39.3	29.0	18.5	13.8	9.9	6.8
18	33.7	27.3	17.3	12.9	9.2	6.5
20	31.1	25.6	16.1	11.4	8.6	6.2
22	28.9	24.1	15.2	10.6	8.0	5.9
24	26.2	22.6	14.3	10.1	7.5	5.5
26	24.0	21.1	13.6	9.5	7.1	5.3
28	22.5	19.8	13.0	9.0	6.7	5.1
30	20.6	18.7	12.5	8.7	6.4	4.8
32	19.0	17.6	11.4	8.3	6.2	4.6
34	17.7	16.3	11.0	7.9	6.0	4.4
36	16.6	15.2	10.7	7.6	5.7	4.3
38	15.6	14.4	10.3	7.3	5.5	4.1
40	14.7	13.6	9.9	7.1	5.3	3.9
42	14.0	12.8	9.6	6.8	5.2	3.8
44	13.3	12.1	9.2	6.5	5.0	3.6
46	12.5	11.0	9.0	6.3	4.8	3.5
48	11.2	10.7	8.7	6.1	4.7	3.4
50	10.9	10.2	8.2	6.0	4.5	3.3
55	9.5	8.9	7.4	5.4	4.2	3.0
60	8.1	7.8	6.6	4.9	3.8	2.8
65	6.9	6.7	5.7	4.5	3.4	2.4
70		5.8	5.1	4.0	3.1	2.1
75			4.3	3.6	2.8	
80			3.7	3.2	2.6	
85			3.2	2.8	2.3	
90				2.4		

Pluma principal 55 m

Capacidad en toneladas: Contrapeso de 81 t y contrapeso central de 36 t						
Radio (m)	Longitud de pluma - L en (m)					
	78	90	96	102	108	114
7.5	40.0					
9	39.3	27.2	22.6			
10	38.1	26.6	22.5	18.9	12.1	
12	35.1	24.8	21.2	17.9	12.1	10.7
14	32.6	22.6	20.0	16.7	12.1	10.1
16	30.5	21.3	18.7	15.6	11.9	9.7
18	28.6	20.0	17.8	14.6	11.2	9.0
20	27.0	18.9	16.7	13.8	10.7	8.5
22	25.1	18.0	15.8	12.9	10.1	8.0
24	23.2	17.1	15.2	12.3	9.5	7.5
26	22.2	16.4	14.6	11.2	9.1	7.1
28	20.1	15.9	14.1	10.6	8.6	6.8
30	18.5	15.1	13.7	10.2	8.3	6.5
32	17.2	14.4	13.2	9.9	8.0	6.3
34	15.8	13.7	12.5	9.5	7.7	6.1
36	14.6	13.2	11.2	9.1	7.4	6.0
38	13.5	12.5	11.0	8.8	7.1	5.8
40	12.7	10.9	10.7	8.5	6.9	5.6
42	11.7	10.2	9.8	8.3	6.6	5.4
44	11.1	9.6	9.1	7.8	6.5	5.3
46	10.6	9.1	8.4	7.4	6.2	5.1
48	10.1	8.6	7.9	7.0	5.9	4.9
50	9.7	8.1	7.4	6.7	5.7	4.7
55	8.2	7.2	6.5	5.9	5.2	4.2
60	6.9	6.3	5.8	5.2	4.6	3.8
65	5.9	5.3	5.0	4.7	4.0	3.4
70	5.1	4.6	4.2	4.0	3.6	3.0
75	4.3	3.9	3.6	3.3	2.9	2.6
80		3.3	3.0	2.8	2.4	
85		2.8	2.5	2.3		
90			2.0			

Esta tabla de cargas sirve únicamente como información. Para trabajos de elevación consultar la tabla de carga de la cabina o el manual.

Configuración de pluma L con pluma principal de 55 m (N° 2320.xx / N° 1916.xx)

Configuración para longitud de pluma (74.1 m - 119.1 m)														
Pie de pluma	Longitud	Número de tramos de pluma y de plumín abatible												
		1	1	1	1	1	1	1	1	1	1	1	1	1
Tramo pluma	3.0 m	1	1	1	1	1	1	1	1	1	1	1	1	1
Tramo pluma	6.0 m	1	1	1	1	1	1	1	1	1	1	1	1	1
Tramo pluma	12.0 m	3	3	3	3	3	3	3	3	3	3	3	3	3
Tramo cónico	12.0 m	1	1	1	1	1	1	1	1	1	1	1	1	1
Tramo plumín abatible	3.0 m	1		1		1		1		1		1		1
Tramo plumín abatible	6.0 m		1	1			1	1			1	1		
Tramo plumín abatible	12.0 m				1	1	1	1	2	2	2	2	3	3
Cabeza plumín abatible	8.0 m	1	1	1	1	1	1	1	1	1	1	1	1	1
Longitud máx. pluma L (m)		78	81	84	87	90	93	96	99	102	105	108	111	114

Tablas de cargas - plumín abatible (N° 1916.xx)

Pluma principal con ángulo 88°

Pluma principal 23 m

Radio (m)	Longitud de plumín (m)							
	20	29	41	53	62	71	83	95
9	63.7							
10	55.9	52.0						
13	44.1	40.8	36.0					
15	37.8	33.7	31.7	25.5				
17	33.2	30.9	27.8	23.3	18.2			
19	29.3	27.5	24.9	21.6	17.6	12.9		
22	25.2	23.4	20.7	18.7	16.0	12.4	7.7	
24		21.3	19.3	17.2	14.9	12.1	7.5	4.7
30		17.0	15.4	13.9	12.4	10.3	7.0	4.6
42			10.7	9.5	8.6	7.5	6.0	3.8
50				7.7	6.9	6.2	5.0	3.4
55					6.1	5.4	4.5	3.0
60					5.6	4.8	3.9	2.7
65						4.4	3.4	2.5
70						3.9	3.0	2.1
75							2.7	
80							2.3	

Pluma principal 35 m

Radio (m)	Longitud de plumín (m)							
	20	29	41	53	62	71	83	95
8.3	65.1							
11	54.0	47.6						
13	45.7	41.7	32.7					
16	38.6	33.7	29.6	21.6				
18	33.7	31.6	27.0	20.9	15.5			
19	32.2	29.9	26.0	20.5	15.2	10.8		
22	28.5	25.8	21.9	18.8	14.7	10.5	6.7	
24		22.9	20.9	17.7	14.2	10.2	6.6	4.0
32			12.1	16.4	14.3	12.5	9.3	6.3
42				12.8	11.1	9.9	8.2	5.7
50					9.5	8.4	7.2	5.1
55					8.6	7.6	6.5	4.9
60						6.9	5.9	4.5
65							5.4	4.1
70							4.8	3.8
75								3.4
80								3.0

Pluma principal 44 m

Radio (m)	Longitud de plumín (m)							
	20	29	41	53	62	71	83	95
8.7	50.1							
11	44.5	38.0						
13	40.1	34.4	26.7					
16	33.6	30.1	24.5	18.4				
18	31.3	27.9	22.3	17.6	13.3			
20	28.5	25.4	20.9	16.6	13.1	9.4		
22	26.2	22.9	19.4	15.6	12.7	9.2	5.8	
26		20.3	17.3	14.2	11.3	8.8	5.7	3.4
32		17.0	15.0	12.7	10.3	8.2	5.7	3.4
44			11.3	9.7	8.5	6.9	5.0	3.1
50				8.6	7.3	6.3	4.6	2.9
55				7.6	6.6	5.7	4.3	2.6
60					6.0	5.2	4.0	2.3
65						4.7	3.5	2.2
70						4.2	3.2	
80							2.5	

Pluma principal 53 m

Radio (m)	Longitud de plumín (m)							
	20	29	41	53	62	71	83	95
9	39.3							
11	35.9	29.9						
14	31.1	26.5	21.1					
16	28.4	24.5	19.6	15.0				
18	26.3	22.2	18.2	14.4	11.1			
20	24.2	20.7	17.0	13.6	10.8	7.8		
24	12.1	18.2	15.0	12.2	9.7	7.5	4.9	
26		17.2	14.2	11.1	9.2	7.3	4.8	2.8
32		15.4	12.7	9.9	8.3	6.6	4.7	2.8
44			10.1	8.0	6.7	5.4	4.0	2.5
50				7.3	6.1	5.0	3.6	2.3
55				6.6	5.7	4.6	3.3	
60					5.2	4.2	3.0	
65						3.9	2.7	
70						3.5	2.4	
75							2.2	

Pluma principal 56 m

Radio (m)	Longitud de plumín (m)						
	20	29	35	41	53	62	80
9.1	36.0						
11	33.0	27.7					
13	30.0	25.9	22.9				
14	28.8	24.8	22.0	19.7			
16	26.4	22.6	20.3	18.3	14.0		
18	24.5	20.9	18.9	17.0	13.5	10.3	
20	22.1	19.4	17.5	16.0	12.8	10.0	7.5
22	20.9	18.0	16.5	14.8	11.3	9.4	7.4
24	12.1	17.1	15.5	14.0	10.9	8.9	7.2
32		14.6	13.1	11.3	9.2	7.5	6.5
38			11.6	10.5	8.2	6.7	5.9
44				9.6	7.4	6.0	5.4
55					6.2	5.2	4.5
60						4.8	4.1
70							3.4
80							2.0

Pluma principal 59 m

Radio (m)	Longitud de plumín (m)					
	20	29	35	41	53	62
9.2	33.1					
12	29.6	24.9				
13	28.1	24.0	21.2			
14	26.9	22.7	20.4	18.2		
16	24.8	21.0	18.9	17.0	13.0	
18	22.7	19.4	17.6	15.7	12.5	9.6
19	21.8	18.8	16.9	15.3	12.2	9.6
20	21.0	18.0	16.3	14.8	11.4	9.3
22	19.7	16.7	15.3	13.8	10.6	8.8
24	12.1	15.8	14.4	13.1	10.0	8.3
32		13.7	12.2	10.7	8.5	7.0
38			11.0	9.7	7.5	6.2
44				8.9	6.8	5.4
50					6.3	5.0
55					5.9	4.7
60						4.5

Capacidades de cargas indicadas en toneladas, con plumín abatible (N° 1916.xx), 81 t contrapeso y contrapeso central de 36 t. Estas tablas de cargas sirven únicamente como información. Para trabajos de elevación consultar las tablas de cargas de la cabina o el manual.

Tablas de cargas - plumín abatible (N° 1916.xx)

Pluma principal con ángulo 83°

Pluma principal 23 m

Radio (m)	Longitud de plumín (m)							
	20	29	41	53	62	71	83	95
11.7	57.4	t	t	t	t	t	t	t
15	43.5	41.0						
18	35.0	32.5	29.5					
22	27.4	25.9	22.9	21.2				
24	24.9	23.4	21.1	19.2	15.9			
28		19.5	18.0	16.3	14.6	11.0		
32		17.0	15.6	14.3	13.0	10.5	7.1	
34			14.6	13.4	12.3	10.1	6.9	4.5
44			10.7	9.7	8.9	7.9	6.1	3.9
50				8.2	7.5	6.7	5.4	3.5
55				7.2	6.5	5.9	4.8	3.2
60					5.9	5.2	4.3	2.9
65					5.2	4.7	3.8	2.6
70						4.2	3.3	2.3
75							2.9	
80							2.5	
85							2.2	

Pluma principal 35 m

Radio (m)	Longitud de plumín (m)							
	20	29	41	53	62	71	83	95
13.1	55.2	t	t	t	t	t	t	t
16	44.9	41.0						
20	35.1	32.5	28.3					
24	29.2	26.9	23.0	19.3				
26	27.0	24.9	21.9	18.6	14.3			
28		22.3	20.6	17.8	14.1	10.0		
32		20.3	18.2	16.1	13.5	9.7	6.4	
34		19.2	17.2	15.3	13.1	9.6	6.4	
36			16.3	14.5	12.8	9.3	6.3	3.9
46			12.9	11.0	10.2	8.3	5.6	3.6
55				9.4	8.3	7.2	5.1	3.1
60					7.6	6.5	4.9	2.8
65					6.9	5.9	4.5	2.6
70						5.4	4.2	2.3
75						4.9	3.9	2.1
80							3.6	
85							3.2	

Pluma principal 44 m

Radio (m)	Longitud de plumín (m)							
	20	29	41	53	62	71	83	95
14.2	40.6	t	t	t	t	t	t	t
17	35.9	31.0						
22	28.6	25.6	21.1					
24	26.5	22.9	19.8	15.7				
26	25.1	22.0	18.7	15.3				
28		21.0	17.9	14.7	12.2			
30		20.0	17.1	14.2	11.4	8.8		
34		18.3	15.9	13.4	10.7	8.5	5.7	
36		12.1	15.2	12.9	10.4	8.3	5.6	
38			14.5	12.4	10.2	8.1	5.6	3.4
46			12.5	10.4	8.9	7.3	5.2	3.3
55				8.9	7.6	6.4	4.6	2.9
65					6.5	5.4	4.0	2.4
70						5.1	3.7	2.2
75						4.7	3.5	
85							2.9	

Pluma principal 53 m

Radio (m)	Longitud de plumín (m)							
	20	29	41	53	62	71	83	95
15.3	32.1	t	t	t	t	t	t	t
18	28.7	24.6						
22	24.4	21.0	17.3					
26	21.4	18.6	15.5	12.6				
28	20.5	17.8	14.8	12.2	9.6			
32		16.4	13.7	10.9	9.1	7.2		
34		15.9	13.3	10.5	8.8	7.1	4.8	
36		15.4	12.9	10.2	8.5	6.9	4.8	
38			12.4	9.8	8.2	6.6	4.7	2.8
48			10.4	8.3	6.9	5.6	4.2	2.6
55				7.4	6.2	5.1	3.7	2.4
60				6.8	5.8	4.7	3.4	2.1
65					5.5	4.4	3.1	
75						3.8	2.6	
80							2.4	
85							2.2	

Pluma principal 56 m

Radio (m)	Longitud de plumín (m)							
	20	29	35	41	53	62	71	80
9.1	36.0	t	t	t	t	t	t	t
11	33.0	27.7						
13	30.0	25.9	22.9					
14	28.8	24.8	22.0	19.7				
16	26.4	22.6	20.3	18.3	14.0			
18	24.5	20.9	18.9	17.0	13.5	10.3		
20	22.1	19.4	17.5	16.0	12.8	10.0	7.5	
22	20.9	18.0	16.5	14.8	11.3	9.4	7.4	5.4
24	12.1	17.1	15.5	14.0	10.9	8.9	7.2	5.3
32		14.6	13.1	11.3	9.2	7.5	6.5	5.1
38			11.6	10.5	8.2	6.7	5.9	4.7
44				9.6	7.4	6.0	5.4	4.3
55					6.2	5.2	4.5	3.6
60						4.8	4.1	3.3
70							3.4	2.7
80								2.0

Pluma principal 59 m

Radio (m)	Longitud de plumín (m)						
	20	29	35	41	53	62	
16	27.0	t	t	t	t	t	
19	24.1	20.5					
22	21.0	18.4	16.7				
24	19.8	17.2	15.7	14.2			
26	18.7	16.2	14.8	13.5	10.3		
28	18.0	15.5	14.2	13.0	10.0		
30		14.9	13.6	12.5	9.7	8.1	
38		11.9	11.5	10.4	8.3	6.9	
42			10.9	9.7	7.7	6.4	
46				9.2	7.2	6.0	
48				9.0	7.0	5.8	
50					6.8	5.6	
55					6.3	5.2	
60					5.9	4.8	
65						4.6	
70						4.3	

Capacidades de cargas indicadas en toneladas, con plumín abatible (N° 1916.xx), 81 t contrapeso y contrapeso central de 36 t. Estas tablas de cargas sirven únicamente como información. Para trabajos de elevación consultar las tablas de cargas de la cabina o el manual.

Tablas de cargas - plumín abatible (N° 1916.xx)

Pluma principal con ángulo 75°

Pluma principal 23 m

Radio (m)	Longitud de plumín (m)							
	20	29	41	53	62	71	83	95
17.5	t	t	t	t	t	t	t	t
22	44.8							
28	32.6	31.4						
32	12.1	22.7	21.4					
36		19.2	18.0	16.9				
40		16.6	15.6	14.6	13.6			
46			13.6	12.8	11.6	9.8		
48			11.0	10.4	9.7	8.9	6.1	
50			10.5	9.7	9.1	8.3	6.0	
55				9.2	8.6	7.8	5.8	3.7
60				8.0	7.4	6.8	5.4	3.4
65				6.9	6.5	5.9	5.0	3.1
70					5.8	5.2	4.5	2.8
75						4.6	3.9	2.6
80						4.1	3.4	2.3
85							3.0	
85							2.5	

Pluma principal 35 m

Radio (m)	Longitud de plumín (m)							
	20	29	41	53	62	71	83	95
20.6	t	t	t	t	t	t	t	t
26	38.0							
30	30.3	28.7						
36	25.8	24.9	23.2					
40		20.4	19.3	17.4				
44			12.1	17.2	15.8	13.1		
48				15.3	14.1	12.7	9.0	
50				13.7	12.9	11.3	8.7	5.7
55				12.9	12.3	10.9	8.5	5.6
60					10.7	9.8	8.1	5.4
65					9.6	8.7	7.6	5.1
70						7.9	6.9	4.9
75						7.1	6.3	4.7
80							5.7	4.4
85							5.2	4.2
90								3.8
90								3.5

Pluma principal 44 m

Radio (m)	Longitud de plumín (m)							
	20	29	41	53	62	71	83	95
22.9	t	t	t	t	t	t	t	t
28	29.3							
32	25.3	22.6						
38	22.5	20.5	17.6					
42		17.8	15.8	13.5				
46		15.9	14.7	12.8	10.2			
48			13.4	11.4	9.7	7.6		
50			12.8	11.1	9.5	7.5		
55			12.2	10.8	9.2	7.4	5.0	
60				9.8	8.6	7.0	4.9	2.9
65				8.9	7.9	6.6	4.7	2.8
70				8.0	7.3	6.1	4.4	2.7
75					6.6	5.7	4.1	2.4
80						5.2	3.9	2.2
85						4.7	3.6	
90							3.3	
90							2.9	

Pluma principal 53 m

Radio (m)	Longitud de plumín (m)							
	20	29	41	53	62	71	83	95
25.2	t	t	t	t	t	t	t	t
30	24.4							
32	21.4	19.1						
36	20.3	18.3						
40	12.1	16.8	14.4					
44		15.2	13.4	10.7				
48		13.8	12.5	10.1	8.4			
50			11.2	9.5	8.1	6.3		
55			10.9	9.2	7.8	6.3		
60			9.8	8.4	7.2	5.9	4.2	
65				7.7	6.6	5.5	4.1	2.4
70				7.0	6.1	5.1	3.8	2.3
75					5.6	4.7	3.5	2.2
80					5.1	4.3	3.2	
85						3.8	2.9	
90						3.3	2.5	
90							2.1	

Pluma principal 56 m

Radio (m)	Longitud de plumín (m)							
	20	29	35	41	53	62	71	80
26	t	t	t	t	t	t	t	t
30	21.9							
34	20.0	17.7						
36	18.4	16.4	15.2					
40	17.4	15.7	14.6	13.5				
44		14.5	13.5	12.5	9.7			
48		13.2	12.6	11.2	9.3	7.5		
50			11.5	10.5	8.7	7.3	6.0	
55			10.9	10.1	8.4	7.1	6.0	
65				9.3	7.7	6.5	5.8	4.6
75					6.6	5.6	5.0	4.1
85						4.7	4.0	3.4
90							3.1	2.5
90								2.1

Pluma principal 59 m

Radio (m)	Longitud de plumín (m)						
	20	29	35	41	53	62	
26.8	t	t	t	t	t	t	
32	20.3						
34	18.0	16.0					
36	17.3	15.3	14.1				
42	16.7	14.6	13.6	12.4			
46		13.1	12.2	10.7	8.7		
48		11.9	10.9	10.0	8.2	6.8	
50			10.6	9.7	7.9	6.7	
55			10.3	9.3	7.6	6.4	
60				8.7	7.0	5.9	
65					6.4	5.5	
70					6.0	5.1	
75						4.7	
75						4.4	

Capacidades de cargas indicadas en toneladas, con plumín abatible (N° 1916.xx), 81 t contrapeso y contrapeso central de 36 t. Estas tablas de cargas sirven únicamente como información. Para trabajos de elevación consultar las tablas de cargas de la cabina o el manual.

Tablas de cargas - plumín abatible (N° 1916.xx)

Pluma principal con ángulo 65°

Pluma principal 23 m

Radio (m)	Longitud de plumín (m)							
	20	29	41	53	62	71	83	95
24.3	33.3	t						
30	25.6	25.3						
32	12.1	22.9						
38		18.0	17.4					
40		16.5	16.0					
44			13.9	13.5				
46			13.0	12.6				
50			11.1	10.8	10.2			
55				9.1	8.8	7.6		
60				7.9	7.5	6.9		
65					6.5	6.0	4.9	
70					5.7	5.2	4.6	2.7
75						4.7	4.0	2.5
80						4.1	3.5	2.3
90							2.6	

Pluma principal 35 m

Radio (m)	Longitud de plumín (m)							
	20	29	41	53	62	71	83	95
29.3	24.2	t						
36	18.7	18.3						
42		15.0	14.4					
44		14.1	13.6					
48			12.1					
50			11.5	10.7				
55			10.0	9.5	8.8			
60				8.3	7.8	7.0		
65				7.3	6.9	6.2		
70					6.1	5.4	4.5	
75					5.4	4.8	3.9	2.6
80						4.3	3.4	2.3
85						3.7	2.9	2.1
90							2.5	
95							2.1	

Pluma principal 44 m

Radio (m)	Longitud de plumín (m)							
	20	29	41	53	62	71	83	95
33.1	18.7	t						
40	15.0	14.3						
46		12.1	11.1					
48		11.5	10.5					
55			8.9	7.9				
60			7.9	7.0	6.3			
65				6.2	5.6	4.8		
70				5.6	4.9	4.1	3.2	
75					4.4	3.6	2.7	
80					3.9	3.1	2.2	
85						2.7		
90						2.3		

Pluma principal 53 m

Radio (m)	Longitud de plumín (m)							
	20	29	41	53	62	71	83	95
36.9	14.2	t						
44	11.7	10.8						
46		10.3						
48		9.8						
50		9.3	8.2					
55			7.3					
60			6.4	5.4				
65			5.7	4.8	4.1			
70				4.2	3.6	2.8		
75				3.7	3.1	2.3		
80					2.7			
85					2.3			

Pluma principal 56 m

Radio (m)	Longitud de plumín (m)							
	20	29	35	41	53	62	71	80
38.2	12.9	t						
44	11.0	10.1						
46	10.4	9.6						
48		9.1	8.5					
50		8.6	8.1					
55			7.1	6.7				
60			6.3	5.9	4.9			
65				5.2	4.3	3.6		
70					3.7	3.1	2.3	
75					3.3	2.6		
80						2.2		

Pluma principal 59 m

Radio (m)	Longitud de plumín (m)							
	20	29	35	41	53	62		
39.5	11.5	t						
42	10.8							
44	10.3							
46	9.7	8.9						
48		8.4						
50		8.0	7.4					
55		7.1	6.6	6.1				
60			5.8	5.4	4.4			
65				4.7	3.8	3.1		
70					3.3	2.6		
75					2.8	2.2		

Capacidades de cargas indicadas en toneladas, con plumín abatible (N° 1916.xx), 81 t contrapeso y contrapeso central de 36 t. Estas tablas de cargas sirven únicamente como información. Para trabajos de elevación consultar las tablas de cargas de la cabina o el manual.

Tablas de cargas - plumín abatible (N° 1916.xx)

Pluma principal con ángulo 45°

Pluma principal 23 m

Radio (m)	Longitud de plumín (m)							
	20	29	41	53	62	71	83	95
t	t	t	t	t	t	t	t	t
35.6	18.7							
38	17.1							
44		13.9						
46		13.1						
55			9.8					
65				7.1				
70				6.3	5.8			
75					5.2			
80						4.1		
85						3.5		
90							2.5	
95							2.1	

Pluma principal 35 m

Radio (m)	Longitud de plumín (m)							
	20	29	41	53	62	71	83	95
t	t	t	t	t	t	t	t	t
44.1	11.7							
46	11.1							
55		8.3						
65			5.9					
75				4.0				
80					3.0			
85					2.6			

Pluma principal 44 m

Radio (m)	Longitud de plumín (m)					
	20	29	41	53		
t	t	t	t	t		
50.4	7.9					
60		5.7				
70			3.7			
80				2.0		

Pluma principal 53 m

Radio (m)	Longitud de plumín (m)					
	20	29	41	53	62	71
t	t	t	t	t	t	t
56.8	4.9					
65		3.2				

Pluma principal 56 m

Radio (m)	Longitud de plumín (m)						
	20	29	35	41	53	62	71
t	t	t	t	t	t	t	t
58.9	3.8						
60	3.7						
70		2.1					

Pluma principal 59 m

Radio (m)	Longitud de plumín (m)					
	20	29	35	41	53	62
t	t	t	t	t	t	t
61	2.9					

Capacidades de cargas indicadas en toneladas, con plumín abatible (N° 1916.xx), 81 t contrapeso y contrapeso central de 36 t. Estas tablas de cargas sirven únicamente como información. Para trabajos de elevación consultar las tablas de cargas de la cabina o el manual.

Radio de trabajo - plumín fijo (N° 1008.xx) 15° y 30°

Pluma principal con ángulo 88°- 30°

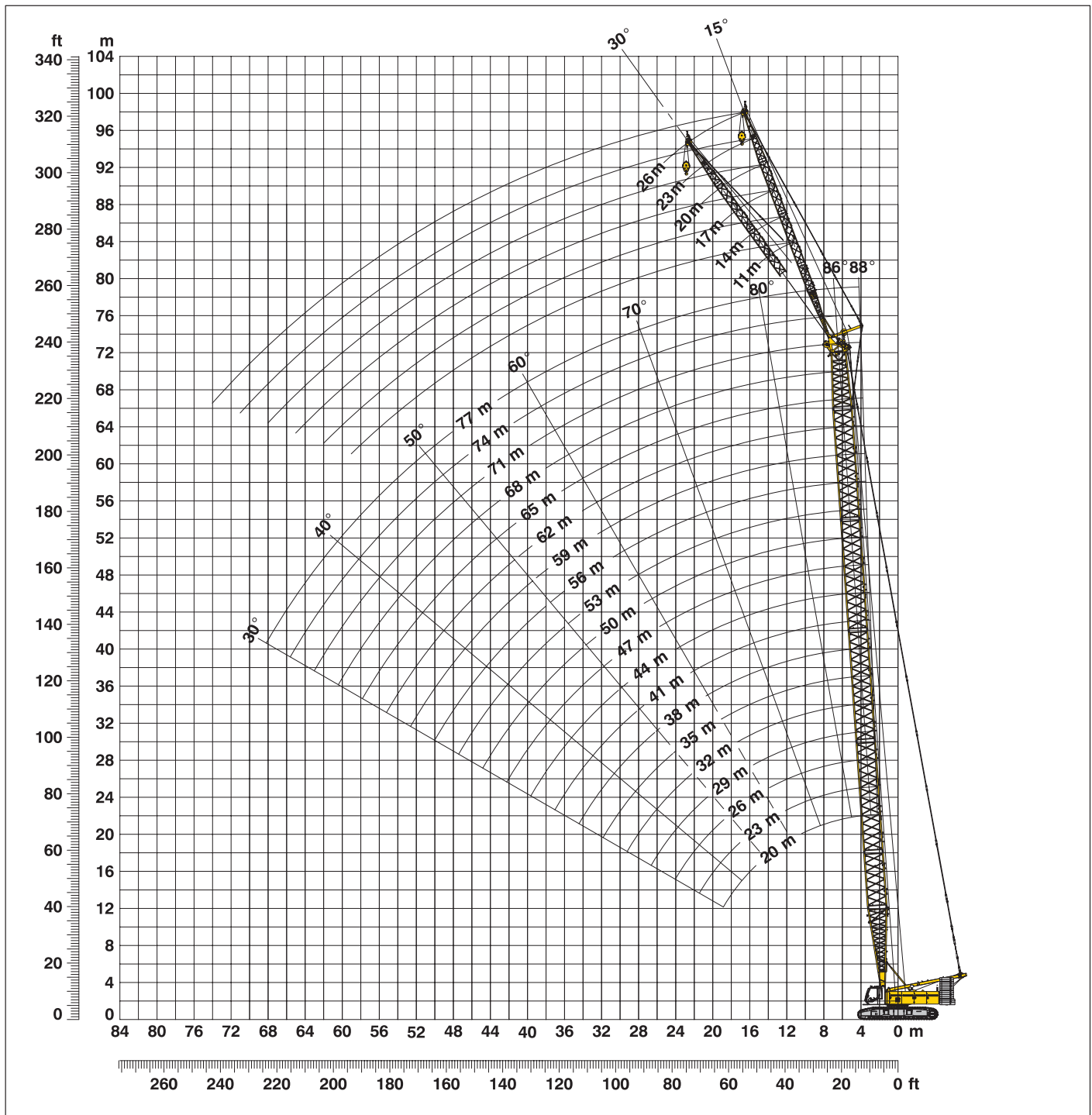

Configuración de pluma principal (20 m - 77 m) – vea tabla 1 en la pagina 10
Configuración del plumín fijo (11 m - 26 m)

	Longitud	Número de tramos de plumín fijo					
Pie plumín fijo	5.5 m	1	1	1	1	1	1
Tramo plumín fijo	3.0 m		1		1		1
Tramo plumín fijo	6.0 m			1	1	2	2
Cabeza plumín fijo	5.5 m	1	1	1	1	1	1
Longitud plumín fijo (m)		11	14	17	20	23	26

Tablas de cargas - plumín fijo (N° 1008.xx)

Con ángulo 15°

Pluma principal 20 m

Radio (m)	Longitud de plumín (m)			
	11	14	20	26
9	t	t	t	t
10	35.9	34.1		
11	35.9	33.3	27.4	
12	35.9	32.6	26.3	19.2
16	35.1	29.8	22.5	16.7
20	32.8	26.5	19.7	14.8
24	27.5	22.6	16.8	13.2
28	24.0	20.5	14.6	11.3
30	23.0	19.3	13.7	10.9
32		18.2	12.9	10.5
38			11.3	8.7
44				7.6

Pluma principal 29 m

Radio (m)	Longitud de plumín (m)			
	11	14	20	26
8	t	t	t	t
9	35.9	34.9		
10	35.9	34.2	28.3	
12	35.9	33.0	26.4	18.9
20	34.7	29.2	20.7	15.1
26	30.5	25.2	17.7	13.3
30	25.0	22.1	15.7	12.1
36	19.2	19.5	13.4	10.6
38	17.7	18.0	12.8	10.1
40		16.7	12.3	9.5
46			11.2	8.3
50				7.7

Pluma principal 38 m

Radio (m)	Longitud de plumín (m)			
	11	14	20	26
7	t	t	t	t
8	35.9	35.4		
10	35.9	34.3	28.1	
13	35.9	33.0	25.9	18.1
20	35.9	30.6	21.5	15.1
30	24.4	24.7	17.5	12.9
40	15.8	16.1	14.0	10.6
44	13.5	13.8	12.9	9.7
46	12.1	12.7	12.5	9.3
48		11.9	12.1	8.9
55			9.7	8.0
60				7.4

Pluma principal 47 m

Radio (m)	Longitud de plumín (m)			
	11	14	20	26
6.6	t	t	t	t
8	35.9	34.4		
11	35.9	33.2	26.2	
13	35.9	32.4	24.9	17.6
18	35.6	30.8	21.7	15.7
20	34.9	30.0	20.8	15.1
30	23.8	24.2	18.2	13.1
40	15.2	15.5	15.1	11.1
50	10.3	10.5	11.0	9.5
55		8.7	9.2	8.7
60			7.6	8.0
65				6.7

Pluma principal 56 m

Radio (m)	Longitud de plumín (m)			
	11	14	20	26
6.9	t	t	t	t
9	35.9	33.5		
11	35.9	32.7	25.1	
13	35.9	32.1	24.2	16.6
20	32.5	28.7	20.6	14.6
30	22.6	22.7	17.9	12.9
40	14.6	14.9	15.3	11.4
50	9.7	9.9	10.4	10.3
60	6.4	6.6	7.1	7.5
65			5.8	6.1
70			4.6	5.0
75				4.0

Pluma principal 62 m

Radio (m)	Longitud de plumín (m)			
	11	14	20	26
7.1	t	t	t	t
9	35.8	32.6		
11	35.2	31.7	23.2	
13	33.8	30.5	22.6	15.9
20	27.7	25.8	19.8	14.2
30	21.6	21.0	17.0	12.7
40	14.2	14.4	14.7	11.3
50	9.3	9.5	10.0	10.2
60	6.0	6.2	6.7	7.1
65	4.7	4.9	5.4	5.7
75			3.3	3.6
80				2.7

Pluma principal 68 m

Radio (m)	Longitud de plumín (m)			
	11	14	20	26
7.3	t	t	t	t
9	34.1	30.2		
11	31.8	29.2	21.7	
14	28.3	26.7	20.8	15.1
20	21.9	21.7	18.4	13.7
30	18.4	17.8	15.4	12.3
40	13.5	13.6	13.8	10.8
50	8.9	9.1	9.5	9.6
60	5.6	5.8	6.3	6.7
70	3.3	3.5	3.9	4.2
75		2.5	2.9	3.3
80			2.0	2.4

Pluma principal 74 m

Radio (m)	Longitud de plumín (m)			
	11	14	17	20
7.5	t	t	t	t
9	29.0	26.1		
10	27.8	26.1	22.8	
12	26.1	24.6	22.4	19.7
20	19.2	18.6	17.7	16.4
30	15.7	15.1	14.4	13.8
40	12.7	12.8	13.0	12.5
50	8.3	8.5	8.7	8.8
60	5.2	5.4	5.6	5.8
65	3.9	4.1	4.4	4.5
70	2.8	3.0	3.3	3.5
75		2.1	2.3	2.5

Pluma principal 77 m

Radio (m)	Longitud de plumín (m)			
	11	14		
7.6	t	t		
9	26.7	23.3		
10	25.8	23.3		
18	19.1	18.2		
20	17.9	17.1		
30	14.6	14.0		
40	12.3	12.4		
50	8.0	8.2		
55	6.4	6.5		
60	5.0	5.1		
65	3.7	3.9		
70	2.7	2.9		

Capacidades de cargas indicadas en toneladas, con plumín fijo (N° 1008.xx), 81 t contrapeso y contrapeso central de 36 t. Estas tablas de cargas sirven únicamente como información. Para trabajos de elevación consultar las tablas de cargas de la cabina o el manual.

Tablas de cargas - plumín fijo (N° 1008.xx)

Con ángulo 30°

Pluma principal 20 m

Radio (m)	Longitud de plumín (m)			
	11	14	20	26
11	t	t	t	t
13	34.7			
15	31.1	26.1		
18	28.3	23.8	16.9	
20	25.1	21.4	14.9	12.1
24	23.3	19.9	13.9	11.3
28	21.3	17.5	12.2	9.7
30	19.5	15.8	11.1	8.5
32	18.9	15.2	10.7	8.0
34		14.8	10.2	7.6
40		12.1	9.7	7.2
46			9.0	6.3
46				6.0

Pluma principal 29 m

Radio (m)	Longitud de plumín (m)			
	11	14	20	26
10	t	t	t	t
12	35.9			
15	34.6	27.7		
18	30.6	25.0	17.1	
20	27.5	23.2	15.5	12.1
24	26.0	21.6	14.5	11.6
28	23.2	19.3	13.0	10.2
30	21.8	17.5	12.0	9.1
38	20.9	16.8	11.5	8.6
40	17.8	14.9	10.0	7.1
46		14.6	9.7	6.9
46			9.1	6.3
50				6.1

Pluma principal 38 m

Radio (m)	Longitud de plumín (m)			
	11	14	20	26
8.9	t	t	t	t
11	35.9			
15	35.7	29.0		
19	32.2	26.6	17.8	
20	28.6	24.0	15.8	12.1
24	27.8	23.9	15.4	11.7
24	25.3	21.4	14.0	10.5
30	22.9	18.8	12.3	9.1
40	16.0	16.0	10.7	7.4
46	12.5	12.9	9.8	6.7
48		12.0	9.6	6.6
55			9.3	6.1
60				6.0

Pluma principal 47 m

Radio (m)	Longitud de plumín (m)			
	11	14	20	26
9.2	t	t	t	t
12	35.9			
15	35.6	28.0		
19	33.6	26.4	17.3	
20	30.1	23.5	15.7	12.0
24	29.5	23.4	15.4	11.8
24	26.8	21.9	14.1	10.7
30	23.4	19.5	12.6	9.4
40	15.5	15.9	11.1	7.9
50	10.4	10.7	9.8	6.8
55		8.8	9.3	6.4
60			7.8	6.1
65				6.0

Pluma principal 56 m

Radio (m)	Longitud de plumín (m)			
	11	14	20	26
9.5	t	t	t	t
12	35.5			
16	34.6	28.1		
19	31.9	26.0	17.4	
20	29.6	24.6	16.3	11.8
24	28.9	24.0	15.9	11.8
30	23.2	20.0	13.3	9.6
40	15.0	15.4	11.7	8.1
50	9.9	10.2	10.5	7.1
60	6.5	6.8	7.3	6.4
65		5.4	6.0	6.2
70			4.7	5.2
75				4.1

Pluma principal 62 m

Radio (m)	Longitud de plumín (m)			
	11	14	20	26
9.8	t	t	t	t
12	33.1			
16	32.4	26.8		
20	29.6	25.1	17.2	
30	26.6	23.0	16.0	11.7
40	21.8	18.8	13.6	9.7
40	14.6	14.9	12.0	8.3
50	9.5	9.9	10.5	7.3
60	6.1	6.4	7.0	6.6
65	4.8	5.1	5.6	6.1
70		3.9	4.4	4.9
75			3.4	3.8
80				2.9

Pluma principal 68 m

Radio (m)	Longitud de plumín (m)			
	11	14	20	26
10	t	t	t	t
12	30.2			
16	29.7	25.2		
20	26.4	23.5	16.8	
30	22.6	21.1	15.9	11.5
40	18.6	17.0	13.4	9.8
40	13.9	14.2	11.7	8.5
50	9.2	9.5	10.1	7.5
60	5.8	6.1	6.7	6.7
65	4.5	4.7	5.3	5.8
70	3.3	3.6	4.1	4.6
75		2.6	3.1	3.5
80			2.1	2.6

Pluma principal 74 m

Radio (m)	Longitud de plumín (m)			
	11	14	17	20
10.2	t	t	t	t
12	26.3			
14	26.2	22.3		
16	24.3	22.2	18.9	
20	22.1	20.8	18.8	16.1
30	19.6	18.4	16.9	15.3
40	15.7	15.0	14.1	12.8
50	13.2	13.4	12.7	11.1
60	8.7	8.9	9.2	9.4
65	5.4	5.7	6.0	6.2
70	4.1	4.4	4.7	4.9
75	3.0	3.2	3.5	3.8
75		2.2	2.5	2.7

Pluma principal 77 m

Radio (m)	Longitud de plumín (m)			
	11	14		
10.3	t	t		
13	24.2			
16	22.7	20.6		
20	20.5	19.2		
30	18.2	17.0		
40	14.7	14.0		
40	12.8	12.8		
50	8.4	8.6		
55	6.7	6.9		
60	5.2	5.5		
65	3.9	4.2		
70	2.8	3.1		
75		2.1		

Capacidades de cargas indicadas en toneladas, con plumín fijo (N° 1008.xx), 81 t contrapeso y contrapeso central de 36 t. Estas tablas de cargas sirven únicamente como información. Para trabajos de elevación consultar las tablas de cargas de la cabina o el manual.

