

Operating Instructions

Wine Chiller

GB

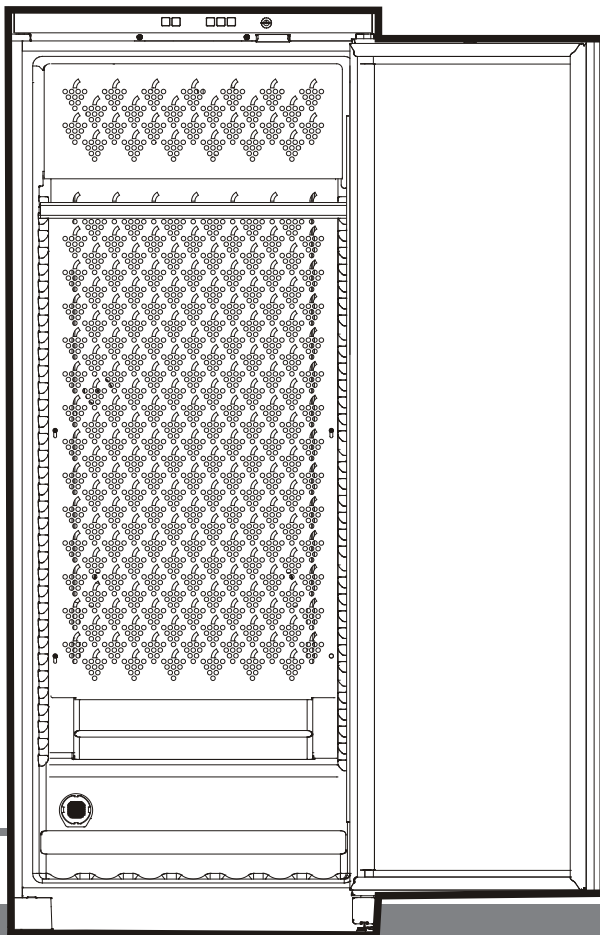

708 4887-02

WKgb 4113

LIEBHERR

Many thanks for your trust.

Congratulations on your purchase of this wine chiller. In buying this product, which is distinguished by its perfect user-friendliness, impeccable reliability and high quality, you have chosen a top class appliance. We wish you a lot of pleasure with your new wine chiller – and a lot of enjoyment from your wines.

The fewer the grapes produced in an area, the better the wine.

Poor, well-drained soils are best for good wine. The properties of the soil influence the vitality of the vine, which in turn affects the quality of the grape. Climate is another factor that is important for wine. Because light and air humidity are important for the development of the flavour of the wine.

The right environment for your wines.

A vine is an extremely sensitive plant. From the time it is planted to its maturing period and the time the grapes are harvested and the wine is made, it is dependent on three factors: light, air humidity and ambient temperature. This sensitivity continues even once the wine is bottled. To allow the flavour of the wine to fully develop or preserve the excellent aroma, the wine has to be stored perfectly – and your wine cooler offers the best conditions for this.

Range of appliance use

The appliance is suited only for storing wine. In the case of commercial food cooling, the pertinent statutory regulations have to be observed. The appliance is not suited for storing and cooling pharmaceutical, blood plasma, laboratory preparations or similar substances and products. Any misuse of the appliance may result in damage to or spoilage of the stored goods. Furthermore, the appliance is unsuited for use in areas exposed to an explosion hazard.

IMPORTANT

The appearance of condensation on the glass door is a natural occurrence due to high humidity, which can occur in high-heat environments, like in hot summer months. Warm and humid ambient air comes in contact with the cooler surface of the glass door, causing moisture from the warm air to condense on the surface of the glass. During periods of considerable condensation, wipe access moisture off of the glass in order to avoid water dripping onto the floor. Condensation on the glass door does not represent a malfunction of the product

Contents

Page

Safety instructions and warnings	5
General information	6
Dimension	6
Electrical connection	6
Setting up	6
Operating and control elements	6
Setting the temperature	6
Switching the appliance on and off	7
Noise emissions from the appliance	7
Ventilation	7
Audible warning signal	7
Additional functions	7
Equipment	7
Air exchange with activated carbon filter	8
Defrosting	8
Cleaning	8
Shutting your appliance down	8
Malfunctions	8
Disposal notes	8

Description of appliance and equipment

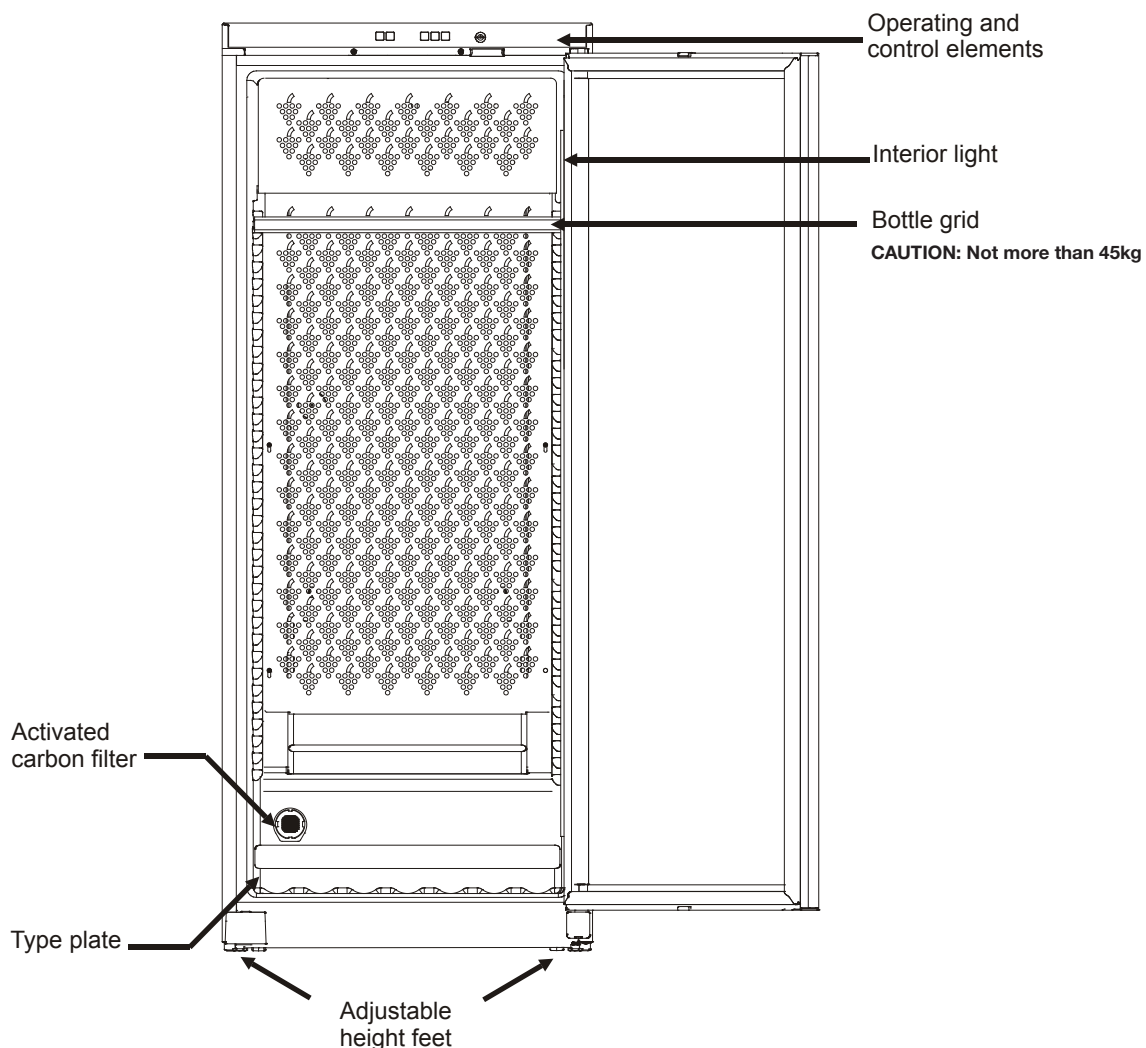

Safety instructions and warnings

- This appliance is not intended for use by persons (including children) with reduced physical, sensory or mental capabilities or lack of experience and knowledge unless they have been given supervision or instruction concerning use of the appliance by a person responsible for their safety.
- Children should be supervised to ensure that they do not play with the appliance.
- **WARNING : If the supply cord is damaged, it must be replaced by the manufacturer, its service agent or similarly qualified persons in order to avoid a hazard.**
- **WARNING : Keep ventilation openings in the appliance enclosure or in the built-in structure clear of obstruction.**
- **WARNING : Do not use mechanical devices or other means to accelerate the defrosting process, other than those recommended by the manufacturer.**
- **WARNING : Do not damage the refrigerant circuit.**
- Do not use electrical appliances inside the food storage compartments of the appliance.
- **WARNING : Do not store explosives substances such as aerosol cans with flammable propellant in this appliance.**
- **WARNING : Risk of fire / flammable materials.**
- The appliance is suited only for cooling food. In the case of commercial food cooling, the pertinent statutory regulations have to be observed. The appliance is not suited for storing and cooling pharmaceuticals, blood plasma, laboratory preparations or similar substances and products subject to the Medical Devices Directive 2007/47/EC. Any misuse of the appliance may result in damage to or spoilage of the stored goods. Furthermore, the appliance is unsuited for use in areas exposed to an explosion hazard.
- To prevent injury damage to the unit, the appliance should be unpacked and set up by at least two people.
- In the event that appliance is damaged on delivery, contact the supplier immediately before connecting to the mains.
- Disconnect the appliance from the mains if any fault occurs by pulling out the plug.
- When disconnecting the appliance, pull on the plug, not on the cable.
- **WARNING : Any repairs and work on the appliance should only be carried out by the customer service department, as unauthorized work could prove highly dangerous for the user. The same applies to changing the mains power cable and lamp.**
- Do not stand on the plinth, drawers or doors or use them to support anything else.
- Avoid prolonged skin contact with cold surfaces or chilled/frozen food. This could cause pain, numbness and frostbite. In the case of prolonged skin contact, protective measures should be taken, e.g. gloves should be worn.
- If you have a lockable appliance, do not keep the key near the appliance or within reach of children.
- Do not allow naked flames or ignition sources to enter the appliance. When transporting and cleaning the appliance ensure that the refrigerant circuit is not damaged. In the event of damage, make sure that there are no ignition sources nearby and keep the room well ventilated.
- To guarantee safe operation, ensure that the appliance is set up and connected as described in these operating instructions.
- Do not consume food which has been stored for too long, as it could cause food poisoning.
- The appliance is designed for use in enclosed areas. Do not operate the appliance outdoors or in areas where it is exposed to splash water or damp conditions.
- Special-purpose lamps (incandescent lamps, LEDs, fluorescent tubes) in the appliance serve to illuminate the appliance interior and are not suited for room illumination.

General information

The refrigerant circuit has been tested for leaks.

The appliance is radio-suppressed to EN 55014 and thus complies with EC directive 87/308/EEC.

All types and models are subject to continuous improvement and the manufacturer therefore reserves the right to make modifications to the sharp, equipment and techno-

Dimension

height: 1644mm, width: 660mm, depth: 670 mm

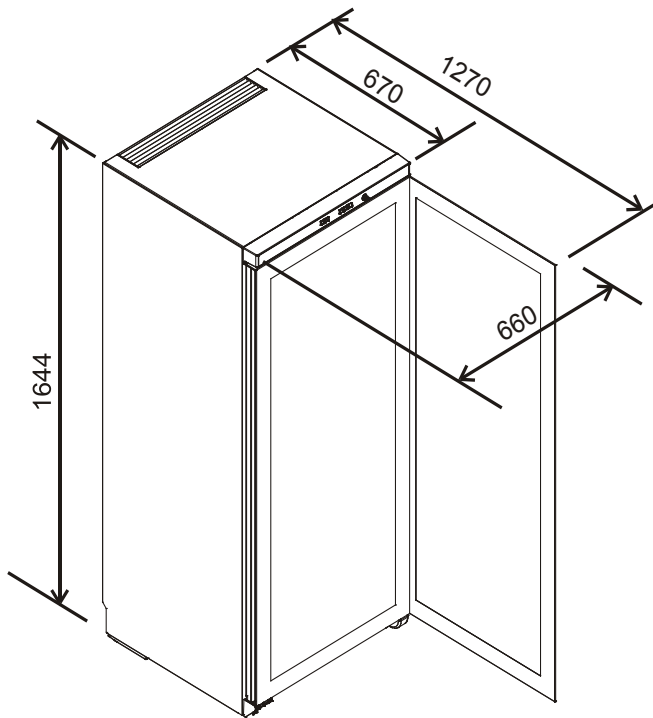

Electrical connection

Only operate the appliance with alternating current (AC).

The permissible voltage and frequency are indicated on the type plate. The position of the type plate is shown in the section entitled Description of the appliance.

The socket must be properly earthed and protected by a fuse.

The tripping current of the fust must be between 10 A and 16 A.

The socket must not be situated behind the appliance and must be easily accesible.

Do not connect the appliance using an extension cable or extension socket.

Do not use stand-alone inverters (conversion of direct current to alternating/ three-phase current) or energy-saving plugs. Risk of damage to the electronic control system!

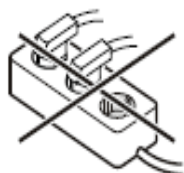

Setting up

- Avoid locating the appliance in direct sunlight or near heat sources such as an oven or a radiator.
- The floor should be level and even. You can compensate for an uneven floor by adjusting the adjustable feet.
- Standard EN 378 specifies that the room in which you install your appliance must have a volume of 1 m³ per 8 g of R600a (R290) refrigerant used in the appliance, so as to avoid the formation of inflammable gas/air mixtures in the room where the appliance is located in the event of a leak in the refrigerant circuit, The quantity of refrigerant used in your appliance is indicated on the type plate on the inside of the appliance.
- The appliance is set to operate within specific ambient temperature limits according to its climate rating. These temperature limits should not be exceeded. The correct climate rating for your appliance is indicated on the type plate.

Climate rating	Room temperature
ST	16° C to + 38°C

Operating and control elements



- 1 Temperature display
- 2 Temperature setting button
- 3 Audible warning on/off button
- 4 Interior light on/off button
- 5 Child - proof lock
- 6 On/off button
- 7 Ventilation on/off button

Setting the temperature

To reduce the temperature : Press the  button.

To increase the temperature : Press the  button.

- While you are entering the temperature, the set temperature will flash on the display.
- You can change the settings in increments of 1°C briefly pressing the button again.
- The electronic controls will switch over automatically about 5 seconds after the last time you pressed the button, and the actual temperature will be displayed.
- Factory temperature setting is +12°C.

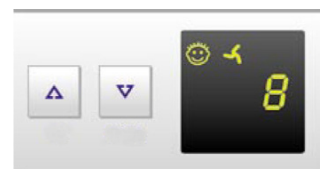

If F1 appears in the display, the appliance has a fault. Consult your nearest customer service point.

Noise emissions from the appliance

The noise level while the appliance is operating below 42.3 dB (A) (relative noise level 1 pW).

Switching the appliance on and off

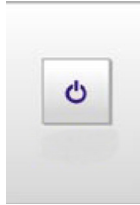

You are recommended to clean the appliance before switching it on for the first time (see "Cleaning"). Connect the appliance to the mains – the appliance is on.

- To switch the appliance off : Keep ON/OFF button pressed for 3 sec. so that the temperature display goes out.
- To switch the appliance on : Press the ON/OFF button until the Display lights up.





Ventilation

Thereby a climate which corresponds to that of a wine cellar is achieved inside the wine cooler. Corks are prevented from drying out due to an increased level of humidity.

To switch on: Press the  button and  button until  symbol appears on the display.



To switch off: Press the  button and  button until  symbol disappears on the display.



Audible warning signal

The audible warning signal helps to protect your wine against excessive temperature fluctuations.

- It sounds when the door has been left open for longer than about 60 seconds. The audible warning device is switched off by pressing the Alarm button.
- It sounds when the interior gets too warm or too cold. The temperature display will also flash. The audible warning device is switched off by pressing the Alarm button. The temperature display will continue to flash until the cause of the alarm has been rectified.

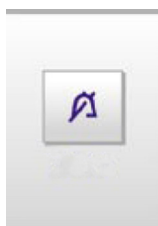

Additional functions

In set-up mode you can set the child-proof lock and adjust the brightness of the display. The child-proof lock is designed to protect the appliance from being switched off accidentally by children.

Activating set-up mode :

- Press Ventilation button for approx. 5 secs - the Ventilation button flashes - the display shows c for child-proof lock.



Note : the value to be altered flashes.

- Select the required function by pressing the Up/Down button :
c = child-proof lock, h = brightness of the display.
- Now select /acknowledge function by pressing Ventilation button briefly :
 - For c = child-proof lock, press the Up/Down button to select
c1 = child-proof lock on or
c0 = child-proof lock off and acknowledge with the Ventilation button. When the symbol  is lit, the child-proof lock is activated.
 - for h = brightness, press Up/Down button to select
h1 = minimum to
h5 = maximum brightness and acknowledge with Ventilation button.

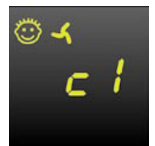

Exit set-up mode :

- Exit the set-up mode by pressing the On/Off button; after 2 min. the electronic system switches over automatically. The normal operating mode is activated again.

Equipment

Labels

The appliance is supplied with a label holder with labels for each shelf. Use these to label the type of wine stored on each shelf. Additional labels can be obtained from your dealer.

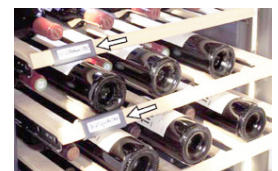

Installation : Click the label holder into place and slide the label in from the side.

Air exchange with activated carbon filter

The way in which wines continue to mature depends on the ambient conditions. The quality of the air is therefore decisive for preserving the wine. An activated carbon filter has been fitted in the lower area of the rear wall of the appliance to ensure that the air throughput remains at an optimum quality.

We recommend that you replace the filter once a year. Filter can be obtained from your dealer.

Changing the filter : Take the filter by the handle. Turn it 90° to the left or right and remove.

Inserting the filter ; Insert with the handle in a vertical position. Turn it 90° to the left or right until it clips into place.



Defrosting

The appliance defrosts automatically. The water that forms on the rear wall drains into a reservoir at the back of the appliance and evaporates automatically through the compressor heat.

Cleaning

Before cleaning always switch off the appliance. Pull out the mains plug.

Never use abrasive or acidic cleaning agents or chemical solvents. We recommend the use of an all-purpose cleaner with neutral pH.

Do not use steam cleaners because of the risk of injury and damage.

- Do not use abrasive sponges or scourers, do not use concentrated cleaning agents and these would damage the surfaces and could cause corrosion.
- Use a glass cleaner to clean the glass surfaces and commercially available stainless-steel cleaning agent for the stainless-steel surfaces.
- Clean the inside and equipment with lukewarm water and little detergent, with the exception of the wooden trims on the grid shelves.
- Ensure that no cleaning water penetrate into the electrical components.
- Dry all parts well with a cloth.
- Do not remove the type plate from the inside of the appliance; it is important for after-sales servicing.

Shutting your appliance down

If your appliance is to be down any length of time, switch it off and disconnect the plug. Clean the appliance and leave the door open in order to prevent unpleasant smells.

Malfunctions

Your appliance is designed and manufactured for lengthy, reliable operating life with no malfunctions. If a malfunction nonetheless occurs during operation, check whether it is due to an operating error. Please note that even during the warranty period the resultant servicing costs in this case will have to be borne by the owner.

You may be able to rectify the following faults by checking the possible causes yourself:

- **Appliance does not function:**
 - Check that the appliance is properly connected to the mains
 - Is the socket fuse intact?
- **Loud running noise:**
 - Check that the appliance is standing firmly on the ground. Please note that it is impossible to avoid flowing noises in the refrigeration circuit.
- **The temperature inside your wine cooler is too warm:**
 - Check the setting in accordance with the section “Setting the temperature”
 - Does the separately installed digital temperature controller show the correct reading?
 - Is the air extraction working properly?
 - Is the wine cooler too close to heat source?
- Please note that, as can happen with other forms of storage, slight mould may form depending on the type of adhesive on the labels. This can be rectified by carefully cleaning any adhesive residues off the bottles.

If none of the above cause apply and you cannot rectify the fault yourself, contact the nearest customer service department

stating the **type ①** of appliance, **index ②** and appliance number **③** as indicated on the type plate. The type plate is located in the refrigerator compartment on the left-hand lower side.

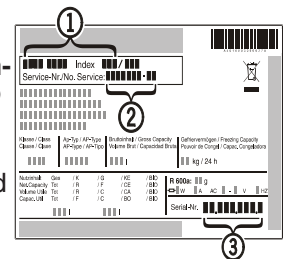

Disposal notes

- Keep packaging materials away from children – polythene sheets and bags can suffocate!
- Please return the packaging material to an official collection point.



Your old appliance: This contains some reusable and flammable materials and should be disposed of properly – not simply with unsorted household refuse.

- Disable discard appliances by removing the plug and cutting through the connection cable. Render the catch unusable so that children cannot become trapped inside.
- Make sure that the refrigerant circuit of an appliance that is no longer needed is not damaged before it is collected or handed at a municipal collection point.
- Details of the refrigerant used can be found on the type plate.
- Information on collection dates or collection points can be obtained from the waste disposal authorities or local council.

Storage diagram

For 750 ml Bordeaux bottles

WKgb 4113 : 168 bottles.

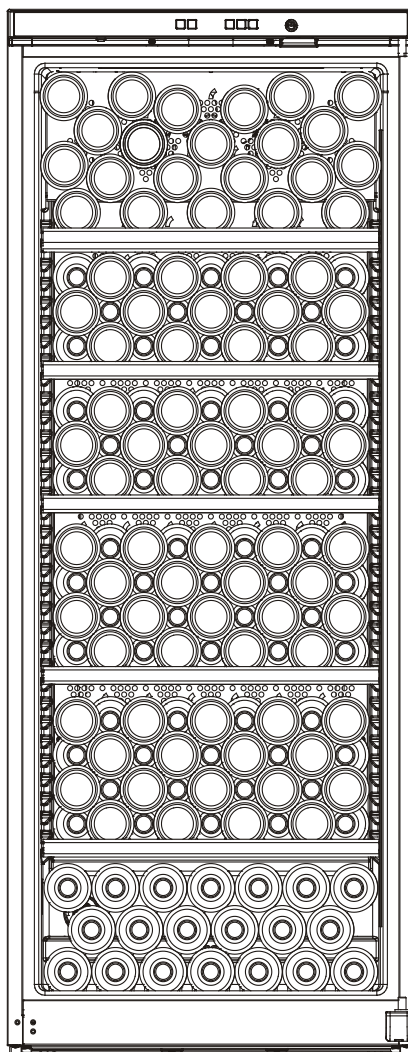

Liebherr Appliances Kluang Sdn Bhd

No.7 Jln Firma 2 , Kaw.Perind.Kluang II, KM7, Jln Mersing, 86007 Kluang, Johor, West Malaysia.
www.liebherr.com.my