

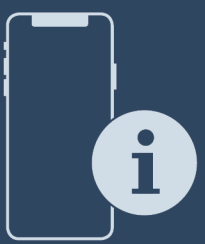

User Guide

Quality, Design and Innovation





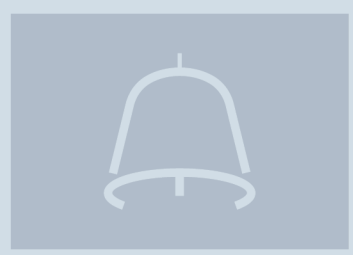





















home.liebherr.com/fridge-manuals



LIEBHERR

Contents

1	The appliance at a glance.....	3		E-Saver	18
1.1	Delivered contents.....	3		IceMaker *.....	18
1.2	Overview of appliances and equipment.....	3	5	IceMaker water inflow*.....	19
1.3	SmartDevice.....	4		MaxIce*	19
1.4	Range of appliance use.....	4		TubeClean *.....	20
1.5	Conformity.....	5		CleaningMode.....	20
2	General safety instructions.....	5		Display Brightness.....	21
3	Functionality of the Touch display.....	7		Door alarm.....	21
3.1	Navigation and symbol explanation.....	7		Input lock.....	22
3.2	Menus.....	7		Appliance information.....	22
3.3	Sleep mode.....	8		Software.....	22
4	Start-up.....	8		Reminder.....	22
4.1	Switching on appliance (first use).....	8		Demo mode.....	23
4.2	Starting the IceMaker for the first time*.....	9		Resetting to factory settings.....	24
5	Storage.....	9	7.3	Messages.....	24
5.1	Information regarding storage.....	9	7.3.1	Overview of warnings.....	24
5.2	Fridge compartment.....	9	7.3.2	Ending warnings.....	25
5.3	EasyFresh	9	7.3.3	Overview of reminders.....	25
5.4	Freezer compartment.....	9	7.3.4	Ending reminders.....	26
5.5	Storage times.....	10	8	Equipment.....	26
6	Energy saving.....	10	8.1	Door racks.....	26
7	Use.....	11	8.2	Shelves.....	26
7.1	Controls and displays.....	11	8.3	Space for baking tray.....	27
7.1.1	Status display.....	11	8.4	Drawers.....	27
7.1.2	Display symbols.....	11	8.5	EasyFresh-Safe.....	29
7.2	Appliance functions.....	11	8.6	Humidity control.....	29
7.2.1	Notes on the appliance functions.....	11	8.7	Glass shelves.....	30
	Switching appliance off and on.....	11	8.8	IceMaker*.....	30
	Switching temperature zone off and on....	12	8.9	VarioSpace.....	30
	WiFi.....	12	8.10	Bottle rack.....	31
	Temperature.....	13	8.11	Flexible ice compartment divider*	31
	Temperature unit.....	14	9	Maintenance.....	31
	SuperCool.....	14	9.1	FreshAir carbon filter.....	31
	PowerCool	15	9.2	Disassembling / assembling pull-out systems.....	32
	SuperFrost.....	15	9.3	Defrosting the appliance.....	32
	Start defrost cycle.....	16	9.4	Cleaning the appliance.....	32
	PartyMode	16	10	Customer support.....	33
	HolidayMode.....	17	10.1	Technical specifications.....	33
	SabbathMode.....	17	10.2	Operating noises.....	34
			10.3	Technical faults.....	34

10.4	Customer Service.....	36
10.5	Rating plate.....	36
11	Decommissioning.....	36
12	Disposal.....	37
12.1	Preparing the appliance for disposal.....	37
12.2	Disposing of the appliance in an environmentally friendly manner.....	37

IC	51..PC / IMPC / IM
ICS	51..

1 The appliance at a glance

1.1 Delivered contents

Check all parts for transport damage. If you have any complaints, please contact the retailer or customer service. (see 10.4 Customer Service)

Delivery contains the following parts:

- Integrated appliance
- Equipment (depending on your model)
- Installation parts (depending on your model)
- User Guide
- Installation Guide
- Warranty documents

Congratulations on the purchase of your new appliance. With this purchase, you have chosen all the advantages of the latest refrigeration technology, guaranteeing you a high-quality appliance with a long life span and high operating safety.

The equipment of your appliance gives you the highest level of day-to-day ease of operation.

Together we are making an active contribution to the conservation of our environment by purchasing this appliance which is manufactured in an environmentally friendly process with the use of recyclable materials.

We hope you enjoy your new appliance.

The manufacturer is constantly working to improve all types and models. Therefore, please be aware that we reserve the right to make changes to the shape, equipment and technology.

1.2 Overview of appliances and equipment

Symbol	Explanation
	Read instructions Please read the information in these instructions carefully to understand all of the benefits of your new appliance.
	Additional information online The digital manual with supplemental information can be found online by scanning the QR code on the front page of this manual or by entering the service number at home.liebherr.com/fridge-manuals .
	Check appliance Check all parts for transport damage. If you have any complaints, please contact your agent or customer service.
	Differences These instructions apply to a range of models, so there may be differences. Sections that apply to certain models only are indicated by an asterisk (*).
	Instructions and results Instructions are marked with a ▶. Results are marked with a ▷.
	Videos Videos about the appliances are available on the YouTube channel of Liebherr-Hausgeräte.

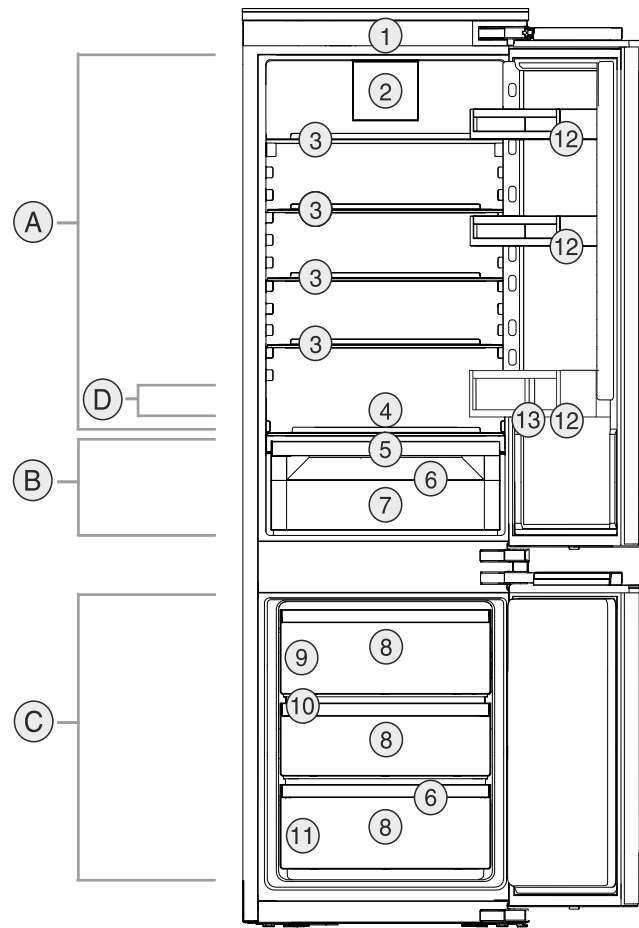

Fig. 1 Example illustration

Temperature range
(A) Fridge compartment **(C)** Freezer compartment

These operating instructions apply to:

The appliance at a glance

- | | |
|--|---------------------------|
| (B) EasyFresh | (D) Coldest zone |
| Equipment | |
| (1) Controls | (8) Freezer drawer |
| (2) Fan with FreshAir activated charcoal filter | (9) IceMaker* |
| (3) Storage shelf | (10) VarioSpace |
| (4) Space for baking tray | (11) Nameplate |
| (5) Cover for EasyFresh-Safe | (12) Door racks |
| (6) Drain hole | (13) Bottle holder |
| (7) EasyFresh-Safe | |

Note

► The shelves, drawers, and baskets are arranged for optimal energy efficiency in the factory configuration. However, changes to the arrangement within the given insertion options – for example the arrangement of shelves in the fridge compartment – have no effect on energy consumption.

1.3 SmartDevice

SmartDevice is the networking solution for your fridge-freezer.

If your appliance is SmartDevice-enabled or compatible, you can quickly and easily connect your appliance to your WiFi. With the SmartDevice app, you can operate your appliance from a mobile device. Additional functions and setting options are available in the SmartDevice app.

SmartDevice-compatible appliance: Your appliance is compatible for use with the SmartDeviceBox. You must first purchase and install the SmartDeviceBox. In order to connect your appliance to the WiFi, you need to download the SmartDevice app.



More information about SmartDevice: smartdevice.liebherr.com

The SmartDeviceBox is available from the Liebherr Service Center. The address for your respective country can be found on the back of the instructions.

Downloading the SmartDevice app:



After installing and configuring the SmartDevice app, you can connect your appliance to the WiFi using the SmartDevice app and the WiFi appliance function (see WiFi).

1.4 Range of appliance use

Normal use

This appliance is intended to be used in household and similar applications such as,

- staff kitchen areas in shops, offices and other working environments;
- farm houses and by clients in hotels, motels and other residential type environments;
- bed and breakfast type environments;
- catering and similar non-retail applications.

All other types of uses are not permitted.

Foreseeable misuse

The following uses are specifically prohibited:

- Storage and cooling of medication, blood plasma, laboratory preparations or similar substances and products in accordance with the CMDCAS and FDA 510(k)
- Use outdoors
- Use in moist areas exposed to the rain
- Use in outdoor areas with very high humidity*
- Use in areas at risk of explosion

Incorrect appliance use can cause damage to the stored products or cause them to spoil.

Climate ratings

The appliance is set to operate within specific ambient temperature limits according to its climate rating. The climate rating for your appliance is printed on the rating plate.

Note

► To guarantee trouble-free operation, comply with the indicated ambient temperatures.

Climate rating	for ambient temperatures from
SN	10 °C (50 °F) to 32 °C (90 °F)

General safety instructions

Climate rating	for ambient temperatures from
N	16 °C (61 °F) to 32 °C (90 °F)
ST	16 °C (61 °F) to 38 °C (100 °F)
T	16 °C (61 °F) to 43 °C (109 °F)
SN-ST	10 °C (50 °F) to 38 °C (100 °F)
SN-T	10 °C (50 °F) to 43 °C (109 °F)

1.5 Conformity

The refrigerant circuit has been tested for leaks. When installed, the appliance complies with the applicable safety regulations and with the corresponding directives.

2 General safety instructions

Please keep these operating instructions in a safe place so you can refer back to them at any time.

If you pass the appliance on, please hand these operating instructions to the new owner.

Read and follow these instructions. They contain safety information which is important for safe and problem-free installation and operation. Always read and follow the safety information.

Dangers for the user:

- This appliance is not intended for use by persons (including children) with reduced physical, sensory or mental capabilities, or lack of experience and knowledge, unless they have been given supervision or instruction concerning use of the appliance by a person responsible for their safety. Children should be supervised to ensure that they do not play with the appliance. Cleaning and user maintenance must not be performed by children unless they are supervised. Children between the ages of 3 and 8 may load and unload the appliance. Children under the age of 3 must be kept away from the appliance unless they are constantly supervised.
- **IMPORTANT:** The power plug must be easily accessible so that the appliance can be disconnected from the mains quickly in an emergency. It must not be behind the back of the appliance.

- The socket must be easily accessible so that the appliance can be disconnected quickly from the electricity in an emergency. It must not be located in the area behind the appliance.
- Always hold the appliance at the plug when disconnecting it from the household power. Do not pull on the cable.
- Disconnect the power plug or fuse if there is a malfunction.
- Do not damage the power cable. Do not operate the appliance with a faulty power cable. If the supply cord is damaged, it must be replaced by the manufacturer, its service agent or similarly qualified persons in order to avoid a hazard. For Plug and Play connections, the change may be carried out by the customer.
- Repairs and work on the appliance may only be carried out by Customer Service or other specifically trained qualified personnel.
- Only install, connect and dispose of the appliance in accordance with the instructions.
- Only operate the appliance after it has been installed.
- The manufacturer is not liable for damage arising from a defective fixed water connection.*

Risk of fire:

- The refrigerant contained within the appliance (specifications on the identification plate) is environmentally friendly, but flammable. Leaking refrigerant can ignite.
 - **WARNING:** Do not damage the refrigerant circuit.
 - Do not handle ignition sources inside the appliance.
 - **WARNING:** Do not use electrical appliances inside the food storage compartments of the appliance, unless they are of the type recommended by the manufacturer (e.g. steam cleaning appliances, heating appliances, ice cream makers).
 - If refrigerant leaks: Remove naked flames or ignition sources located near the area of the leak. Ventilate the room well. Contact Customer Service.
- Do not operate the appliance near explosive gases.

General safety instructions

- Do not store or use gasoline or other flammable gases and liquids near the appliance.
- Do not store explosive substances such as aerosol cans with a flammable propellant in this appliance. You can recognize such spray cans by the printed list of contents or by a flame symbol. Any leaking gases can be ignited by electrical components.
- Alcoholic beverages or other containers holding alcohol must always be tightly sealed for storage purposes. Any leaking alcohol can be ignited by electrical components.

Risk of falling or toppling over:

- **WARNING:** To avoid a hazard due to instability of the appliance, it must be fixed in accordance with the instructions.
- Do not stand on the base, drawers, doors etc. or use them as improper supports. This applies in particular to children.

Danger of poisoning:

- Do not consume spoiled food.
- **WARNING:** Connect to potable water supply only.*
- Do not use any old or already premounted water supply lines.*

Danger of frostbite, feeling of numbness and pain:

- Avoid prolonged skin contact with cold surfaces or chilled/frozen food or take protective measures, e.g. wear gloves.

Risk of injury and damage:

- Hot steam may cause injuries. Do not use any electrical heating or steam cleaning equipment, naked flames or defrosting sprays for defrosting measures.
- **WARNING:** Do not use mechanical devices or other means to accelerate the defrosting process, other than those recommended by the manufacturer.
- Do not remove ice using sharp objects.
- **WARNING:** Keep clear of obstruction all ventilation openings in the appliance enclosure or in the structure for building-in.
- **WARNING:** Risk of child entrapment. Before you throw away your old refrigerator or freezer:
 - Take off the doors.
 - Leave the shelves in place so that children may not easily climb inside.

Risk of crushing:

- Do not hold onto the hinge when opening and closing the door. Fingers may become trapped.

California Proposition 65

- **WARNING:** This product can expose you to chemicals including Diisononyl Phthalate (DINP), which is known to the State of California to cause cancer, and Diisodecyl Phthalate (DIDP), which is known to the State of California to cause birth defects or other reproductive harm. For more information, go to www.P65Warnings.ca.gov

Symbols on the device:



The symbol may be located on the compressor. It refers to the oil in the compressor and refers to the following danger: Can be fatal if swallowed or inhaled. This notice only applies for recycling. There is no danger during normal operation.



WARNING: Risk of fire / flammable materials. The symbol is located on the compressor and indicates the danger from flammable materials. Do not remove the label.



This label or a similar one may be located on the rear of the appliance. This label indicates that there are vacuum insulation panels (VIP) or perlite panels in the door and/or housing. This notice only applies for recycling. Do not remove the label.

Observe the warning messages and other detailed information in the other sections:

	DANGER	Indicates an immediately hazardous situation, which if not avoided, will result in death or serious injury.
	WARNING	Indicates a hazardous situation, which if not avoided, could result in death or serious injury.
	CAUTION	Indicates a hazardous situation, which if not avoided, could result in minor or moderate injury.
	NOTICE	Indicates a hazardous situation, which if not avoided, could result in damage to property.







Note	Indicates useful advice and tips.
------	-----------------------------------

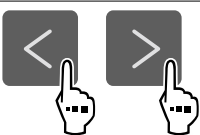

3 Functionality of the Touch display

You operate your appliance using the Touch display. You select appliance functions in the Touch display (hereafter referred to as display) by tapping them. If you do not perform any action on the display for 10 seconds, the display either jumps back to the higher-level menu or directly to the status display.

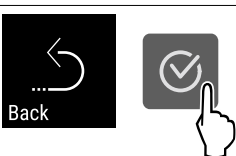
3.1 Navigation and symbol explanation

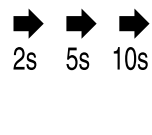
In the illustrations, different symbols are used to navigate the display. The following table describes these symbols.

Symbol	Description
	Press the Next navigation arrow: Navigates to the next option in the menu.
	Press the Back navigation arrow: Jumps back one option in the menu.
	Press the navigation arrow several times in succession: Navigates in the menu to the desired function.
	Press the Confirm symbol: Activates/deactivates function. Opens submenu.
	Press the Confirm symbol together with the back icon: Jumps back one menu level.
	Arrow with clock: It takes more than 10 seconds for the following message to appear in the display.
	Arrow with a time indication: It takes the specified amount of time until the following message appears in the display.

Symbol	Description
	“Open Settings menu” symbol: Navigates to the Settings menu and opens the settings menu. If necessary: Navigate to the desired function in the Settings menu. (see 3.2.1 Opening the Settings menu)
	“Open Advanced menu” symbol: Navigates to the Advanced menu and opens the advanced menu. If necessary: Navigate to the desired function in the Advanced menu. (see 3.2.2 Opening the Advanced menu)
No action for 10 seconds	If you do not perform any action on the display for 10 seconds, the display either jumps back to the higher-level menu or directly to the status display.
Opening door and closing it again	If you open the door and immediately close it again, the display jumps directly back to the status display.

Note: Illustrations of the display are shown in the English version.

3.2 Menus

The appliance functions can be found in various menus.

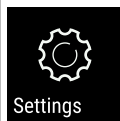
Menu	Description
Main menu	When you switch the appliance on, you are automatically in the main menu. From here you can navigate to the most important appliance functions, to the Settings menu and to the Advanced menu.
 Settings menu	The Settings menu contains additional appliance functions for setting up your appliance. (see 3.2.1 Opening the Settings menu)

Start-up

Menu	Description
Advanced menu	The advanced menu contains special appliance functions for setting up your appliance. Access to the Advanced menu is protected by the numerical code 151 . (see 3.2.2 Opening the Advanced menu)

3.2.1 Opening the Settings menu

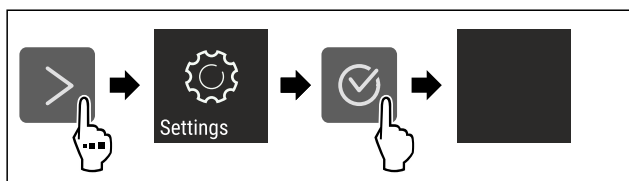

Fig. 2 Example illustration

- ▶ Carry out action steps according to the illustration.
- ▷ Settings menu is open.
- ▶ If necessary: Navigate to the desired function.

3.2.2 Opening the Advanced menu



Fig. 3

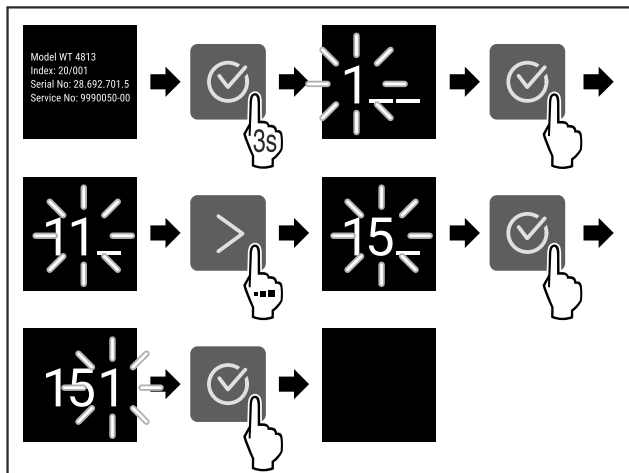

Fig. 4 Example illustration, access with numerical code **151**

- ▶ Carry out action steps according to the illustration.
- ▷ Expanded menu is open.
- ▶ If necessary: Navigate to the desired function.

3.3 Sleep mode

If you do not touch the display for 1 minute, the display switches to sleep mode. In sleep mode, the display brightness is dimmed.

3.3.1 Ending sleep mode

- ▶ Press any navigation key.

- ▷ Sleep mode is ended.

4 Start-up

4.1 Switching on appliance (first use)

Make sure that the following requirements are fulfilled:

- The appliance is properly installed and connected according to the installation instructions.
- All adhesive strips, adhesive and protective films and transport locks are removed from inside and on the appliance.
- All marketing leaflets are removed from the drawers.
- You are familiar with the functionality of the Touch display. (see 3 Functionality of the Touch display)

Switch on the appliance using the Touch display.

- ▶ If the display is in sleep mode: Briefly touch the display.
- ▶ Carry out action steps according to the illustration.

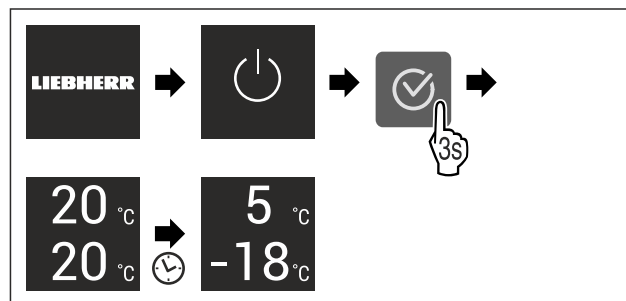

Fig. 5 Example illustration

- ▷ The status display appears.
- ▷ The appliance cools to the temperature set at the factory.
- ▷ The appliance starts in demo mode (status display with DEMO appears): If the appliance starts in demo mode, you can deactivate demo mode within the next 5 minutes. (see Demo mode)

More information:

- Start the IceMaker for the first time. (see 4.2 Starting the IceMaker for the first time*) *
- Start the SmartDevice for the first time. (see 1.3 SmartDevice) and (see WiFi)

Note

The manufacturer recommends:

- ▶ Stock with food: Wait for around 6 hours until the set temperature is reached.
- ▶ **Store frozen foods** at -18 °C (-0 °F) or colder.
- ▶ Observe the notes on storing food. (see 5.1 Information regarding storage)

Note

Accessories can be purchased from the Liebherr Service Center. The address for your respective country can be found on the back of the instructions.

4.2 Starting the IceMaker for the first time*

If your appliance is equipped with IceMaker, you must clean the IceMaker **before using it for the first time**.

Make sure that the following requirements are fulfilled:

- ❑ The water supply has been connected. See Installation Guide or mounting instructions.*
- ❑ The appliance is properly installed and connected.
- ▶ Clean the IceMaker. (see 9.4.4 Cleaning the IceMaker*) *

5 Storage

5.1 Information regarding storage



WARNING

Danger of fire

- ▶ Do not use electrical appliances inside the food storage compartments of the appliance, unless they are of the type recommended by the manufacturer.

Note

Insufficient ventilation results in an increase in energy consumption and reduction of the refrigerating performance

- ▶ Always keep the air slots unobstructed.

Observe the following specifications for storage:

- In the freezer compartment: Package food properly.
- Package or cover foods that readily take on or give off odors or taste in closed containers.
- Package raw meat or fish in clean, closed containers. This will prevent meat or fish from touching or dripping onto other food.
- Keep liquids in closed containers.
- Leave space between goods to ensure good air circulation.
- Store food according to the instructions on the packaging.
- Always observe the best-before date indicated on the packaging.

Note

Failure to follow these guidelines can lead to food-stuffs spoiling.

5.2 Fridge compartment

The air circulation in the appliance creates different temperature zones. You will find the different temperature zones in the appliance and equipment overview. (see 1.2 Overview of appliances and equipment)

5.2.1 Arranging your food properly

- ▶ Upper area and door: Store butter, cheese, canned food and tubes.
- ▶ Coldest temperature zone: Store perishable foods such as pre-cooked meals, meat and lunch meats.
- ▶ Bottom shelf: Store raw meat or fish.

5.3 EasyFresh

EasyFresh is great for non-packaged foods, such as fruit and vegetables.

The humidity in the compartment depends on the moisture content of the chilled goods placed in it, and also depends on how often the compartment is opened. You can regulate the humidity level. (see 8.6 Humidity control)

5.3.1 Arranging your food properly

- ▶ Store unpackaged fruit and vegetables. If the humidity is too high:
- ▶ Regulate the humidity. (see 8.6 Humidity control)

5.4 Freezer compartment

Here, a dry, frosty storage climate is created at -18 °C (-0 °F). The frosty storage climate is suitable for storing frozen food for several months, for making ice cubes or freezing fresh food.

5.4.1 Freezing food

Freezing quantity

The maximum amount of fresh food that you can freeze within 24 hours is specified on the type plate (see 10.5 Rating plate) under "Freezing capacity ... kg/24h."

To ensure that food quickly freezes through, adhere to the following quantities per package:

- Fruit and vegetables up to 1 kg (2.20 lb)
- Meat up to 2.5 kg (5.51 lb)

Freezing food using SuperFrost

Depending on the amount of food to be frozen, you can activate SuperFrost before freezing to reach lower freezing temperatures. (see SuperFrost)

- ▶ Activate SuperFrost if the amount of food you have to freeze is more than approx. 2 kg (4.41 lb).

The time at which you activate SuperFrost depends on the amount of food you have to freeze:

Freezing quantity	Time at which you should activate SuperFrost
Small amount of food to freeze	Activate SuperFrost about 6 hours before freezing. You can place the food in the freezer as soon as the appliance automatically deactivates SuperFrost.

Energy saving

Freezing quantity	Time at which you should activate SuperFrost
Maximum amount of food to freeze	Activate SuperFrost about 24 hours before freezing. You can place the food in the freezer as soon as the appliance automatically deactivates SuperFrost.

Arranging your food properly



CAUTION

Risk of injury from broken glass!
Bottles and cans with beverages can burst during freezing. This applies in particular to carbonated beverages.

- ▶ Only freeze bottles and cans with beverages if you have activated the BottleTimer function in the SmartDevice app.

Freezing quantity	Arranging your food properly
Small amount of food to freeze	Distribute packaged groceries throughout all drawers. If possible, place groceries at the back of the drawer near the rear wall.
Maximum amount of food to freeze	Distribute packaged groceries throughout all drawers. If possible, place groceries at the back of the drawer near the rear wall.

5.4.2 Defrosting food



WARNING

Danger of food poisoning!

- ▶ Do not re-freeze defrosted food.
- ▶ Use defrosted foodstuff as quickly as possible.

You can defrost food in several ways:

- In the fridge compartment
- In the microwave
- In the oven/fan-assisted oven
- At room temperature
- ▶ Take out only as much food as necessary.

5.5 Storage times

The storage times given are guidelines

Food with a “use by” date must still be consumed by the date indicated on the package

5.5.1 Fridge

The best-before date stated on the packaging applies.

5.5.2 Freezer

Guidelines for storage periods for various foods		
Ice cream	at -18 °C (-0 °F)	2 to 6 months
Sausage, ham	at -18 °C (-0 °F)	2 to 3 months
Bread, bakery products	at -18 °C (-0 °F)	2 to 6 months
Game, pork	at -18 °C (-0 °F)	6 to 9 months
Fish, fatty	at -18 °C (-0 °F)	2 to 6 months
Fish, lean	at -18 °C (-0 °F)	6 to 8 months
Cheese	at -18 °C (-0 °F)	2 to 6 months
Poultry, beef	at -18 °C (-0 °F)	6 to 12 months
Vegetables, fruit	at -18 °C (-0 °F)	6 to 12 months

6 Energy saving

- Always ensure good ventilation. Keep clear of obstruction all ventilation openings in the appliance enclosure or in the structure for building-in.
- Never block air slits in the fan.
- Do not install the appliance in an area with direct sunlight, next to a heating unit or similar.
- If you install the appliance directly next to an oven, its energy consumption may increase slightly. This depends on the service life and how often the oven is used.
- Energy consumption depends on installation conditions such as the ambient temperature (see 1.4 Range of appliance use). A warmer ambient temperature can increase the energy consumption.
- Avoid opening the appliance door for any longer than necessary
- The lower the temperature is set the higher the energy consumption.
- Sort your food items: home.liebherr.com/food.
- All food stored in the appliance should be well wrapped and covered. This prevents frost buildup.

- Only take food out for as long as necessary so that it does not get too warm.
- Insertion of warm foods: first let the food cool down to room temperature.
- Defrost frozen food in the fridge
- For longer periods of absence, use HolidayMode (see HolidayMode).

7 Use

7.1 Controls and displays

7.1.1 Status display

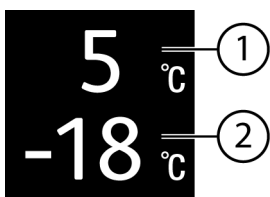





Fig. 6

- (1) Fridge compartment temperature display (2) Freezer compartment temperature display

The Status display shows the set temperatures and is the home display. From there, you can navigate to the options and settings.

7.1.2 Display symbols

The display symbols provide information about the current appliance status.

Symbol	Appliance status
	Standby The appliance or temperature zone is turned off.
	Flashing number Appliance is working. Temperature flashes, until the set value is reached.
	Flashing symbol Appliance is working. Setting is made.
	Bar grows steadily Function is activated.

7.2 Appliance functions

7.2.1 Notes on the appliance functions

The appliance functions are set at the factory so that your appliance is fully functional.

Before you alter, activate or deactivate the appliance functions, make sure that the following requirements are met:

- You have read and understood the descriptions of how the display works. (see 3 Functionality of the Touch display)
- You have familiarized yourself with the operating and display elements of your appliance.



Switching appliance off and on

This function switches the entire appliance on and off.

Switching off the appliance

If you switch off the appliance, the settings that were made before remain stored.

Make sure that the following requirements are fulfilled:

- Handling instructions (see 11 Decommissioning) have been completed.

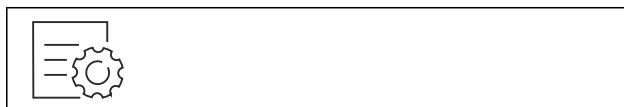

Fig. 7

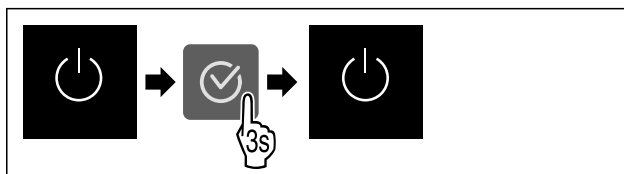

Fig. 8

- ▶ Carry out action steps according to the illustration.
- ▷ Appliance is switched off.
- ▷ Standby symbol appears in the display.
- ▷ Display turns black.

Switching on the appliance

If the display is in sleep mode:

- ▶ Press any navigation key.

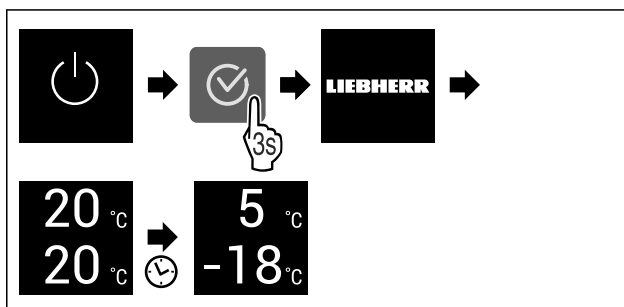

Fig. 9 Example illustration

- ▶ Carry out action steps according to the illustration.
- If the appliance starts in demo mode:
 - ▶ Deactivate demo mode. (see Deactivating demo mode)
 - ▷ Appliance is switched on.
 - ▷ Previously made settings are re-established.
 - ▷ The appliance cools to the set target temperature.

Use

Switching temperature zone off and on

You can switch temperature zones of the appliance off independently.

Application:

- Cleaning
- Defrosting

Switching the fridge compartment off

Make sure that the following requirements are fulfilled:

- Refrigerator compartment has been emptied.

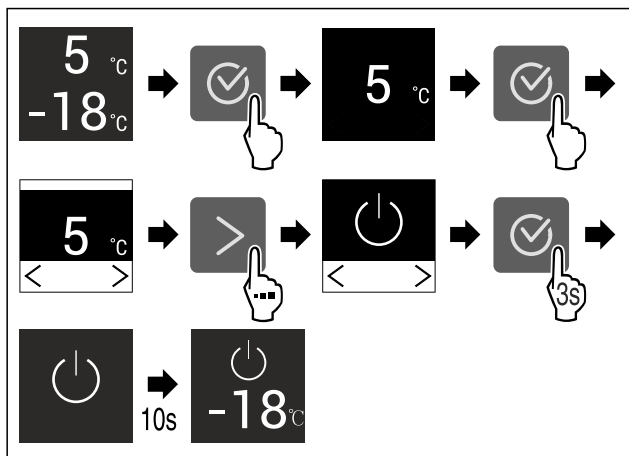

Fig. 10 Example illustration

- ▶ Carry out action steps according to the illustration.
- ▷ Refrigerator compartment is switched off.

Switching the fridge compartment on

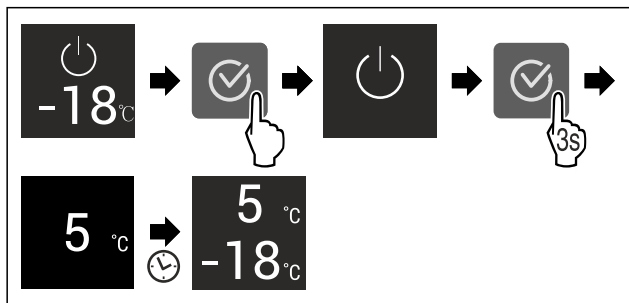

Fig. 11 Example illustration

- ▶ Carry out action steps according to the illustration.
- ▷ Refrigerator compartment is switched on.
- ▷ The appliance cools to the last set temperature.

WiFi

Use this function to connect your appliance to WiFi. You can then operate it via the SmartDevice app on a mobile device. You can also use this function to disconnect or reset the WiFi connection.

To connect your device to WiFi, you need the SmartDeviceBox.

More information on the SmartDevice: (see 1.3 SmartDevice)

Note

The SmartDevice function is not available in the following countries: Russia, Belarus, Kazakhstan.

You cannot use the SmartDeviceBox.

Establishing the WiFi connection for the first time

Make sure that the following requirements are fulfilled:

- You have purchased and inserted a SmartDeviceBox. (see 1.3 SmartDevice)
- You have installed the SmartDevice app (see apps.home.liebherr.com).
- Registration in the SmartDevice app is completed.



Fig. 12

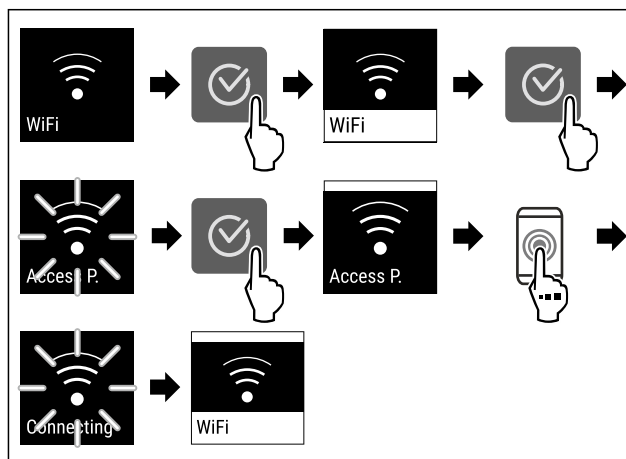

Fig. 13

- ▶ Carry out action steps according to the illustration.
- ▷ Connection is established.

Disconnecting from the WiFi

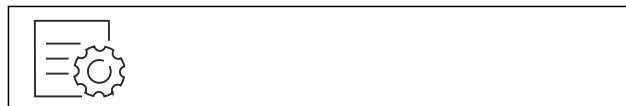

Fig. 14

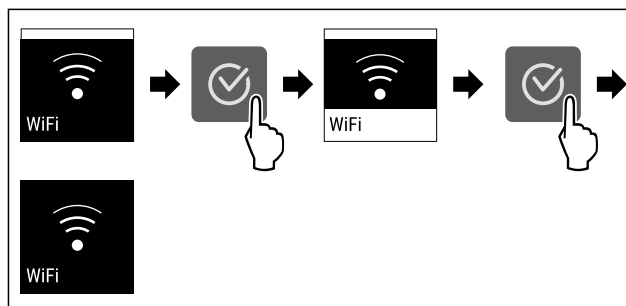

Fig. 15

- ▶ Carry out action steps according to the illustration.

▷ There is no connection.

Resetting the WiFi connection



Fig. 16

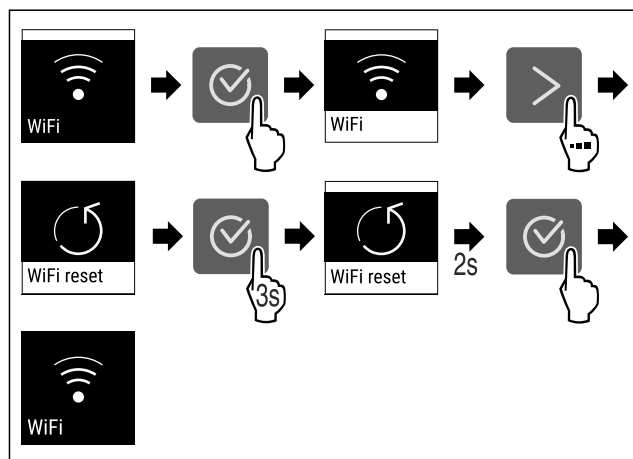

Fig. 17

- ▶ Carry out action steps according to the illustration.
- ▷ WiFi connection and other WiFi settings are reset to factory settings.

Showing information about the WiFi connection



Fig. 18

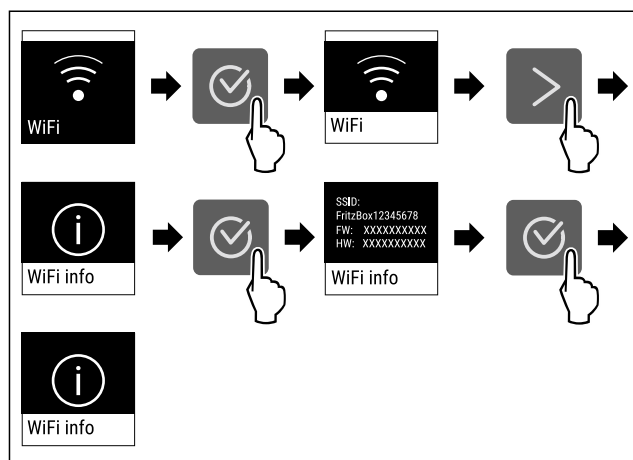

Fig. 19

- ▶ Carry out action steps according to the illustration.

5 °C Temperature

Use this function to set the temperature.

The temperature depends on the following factors:

- How often the door is opened
- How long the door is open
- The room temperature of the installation site
- Type, temperature and amount of food

Temperature zone	Factory-set temperature	Recommended setting
5 °C Fridge section	5 °C (41 °F)	4 °C (39 °F)
-18 °C Freezer section	-18 °C (-0 °F)	-18 °C (-0 °F)

Setting the temperature in the fridge section

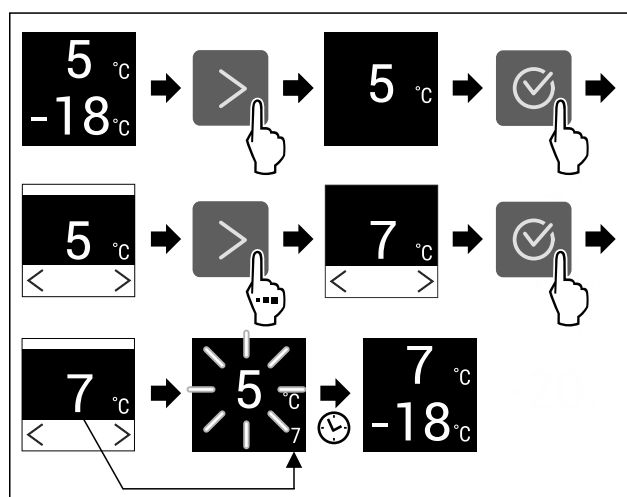

Fig. 20 Example illustration

- ▶ Carry out action steps according to the illustration.
- ▷ Temperature is set.

Use

Setting the temperature in the freezer section

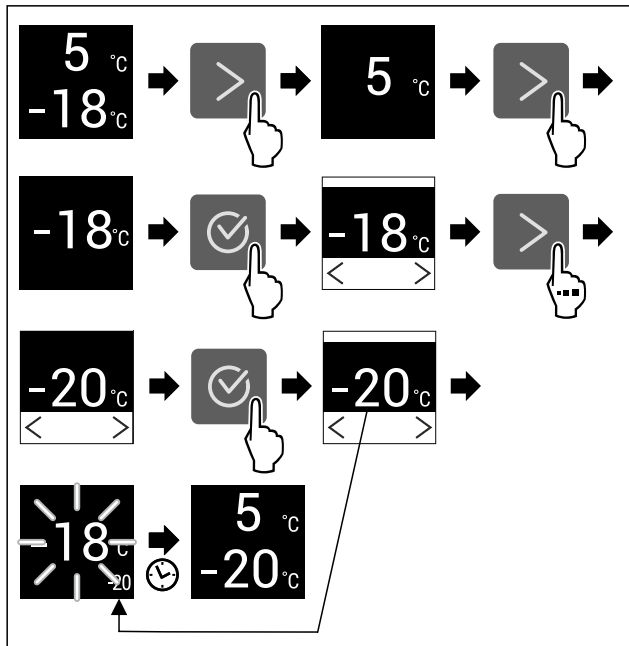

Fig. 21 Example illustration

- ▶ Carry out action steps according to the illustration.
- ▷ Temperature is set.

Temperature unit

Use this function to set the temperature unit. You can set the temperature unit in either degrees Celsius or degrees Fahrenheit.

Setting the temperature unit



Fig. 22

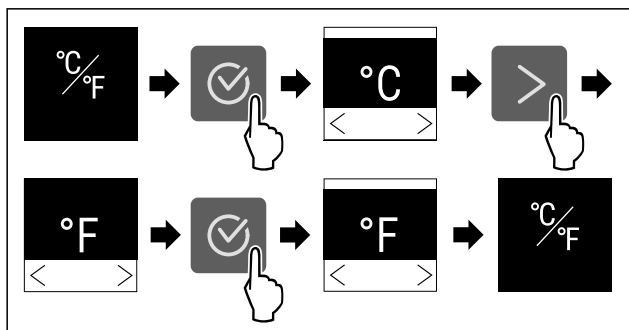

Fig. 23 Example illustration: Switching between degrees Celsius or degrees Fahrenheit.

- ▶ Carry out action steps according to the illustration.
- ▷ Temperature unit is set.

SuperCool

This function activates or deactivates SuperCool. If you activate SuperCool the appliance increases the cooling capacity. This allows you to achieve lower cooling temperatures. You can activate SuperCool if you want to quickly cool large volumes of food.

If the function is active, the appliance operates at a higher output. As a result, the operating noise of the appliance may be temporarily louder, while energy consumption increases.

Activating SuperCool

Time for activating the function:

- If you want to store fresh food in the fridge section: Activate the function when storing food.

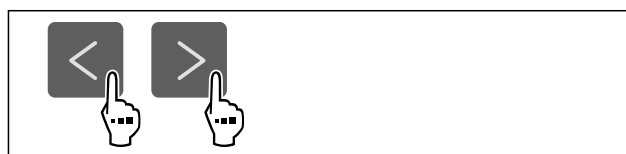

Fig. 24

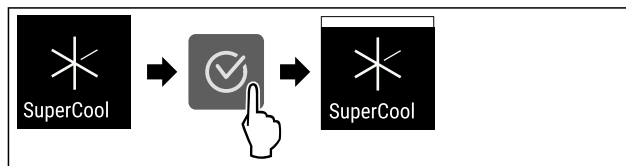

Fig. 25

- ▶ Carry out action steps according to the illustration.
- ▷ SuperCool is activated.

Deactivating SuperCool

SuperCool is automatically deactivated after 18 hours. However, you can also manually deactivate SuperCool at any time:



Fig. 26

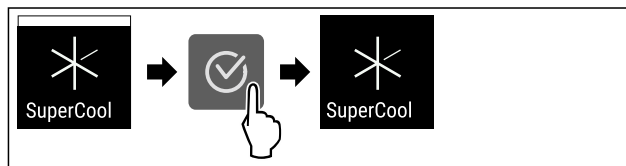

Fig. 27

- ▶ Carry out action steps according to the illustration.
- ▷ SuperCool is deactivated.
- ▷ Appliance continues to run in normal operation.
- ▷ The appliance first cools to the set temperature.

PowerCool

This function activates or deactivates PowerCool. PowerCool ensures optimum temperature layers to keep your food cool.

This function relates to the fridge compartment.

Application:

- At high room temperature (starting at approx. 35 °C (95 °F))
- At high humidity, e. g. on summer days
- While storing moist product to prevent condensation in the interior

Note

The fan can run even if the function is deactivated. It ensures optimum temperature distribution in the appliance.

If the function is active, the appliance operates at a higher output. As a result, the operating noise of the appliance may be temporarily louder, while energy consumption increases.

Activating PowerCool

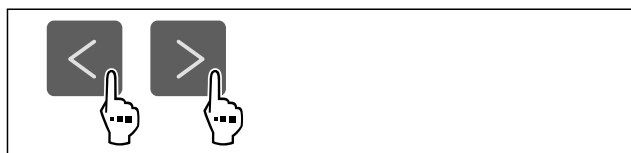

Fig. 28

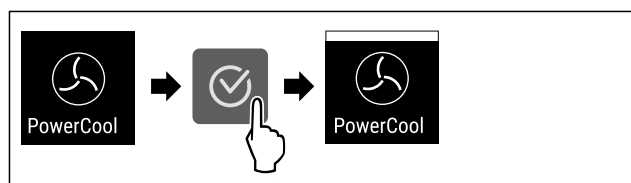

Fig. 29

- ▶ Carry out action steps according to the illustration.
- ▷ PowerCool is activated.

Deactivating PowerCool

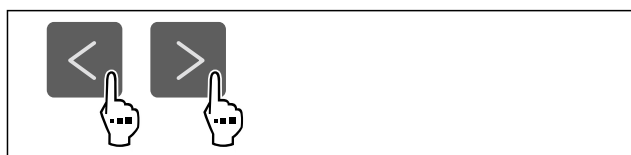

Fig. 30

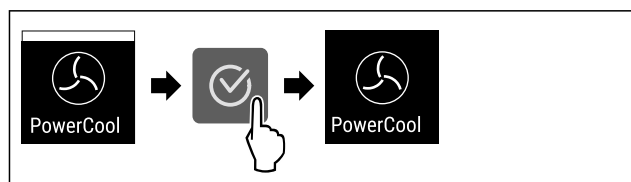

Fig. 31

- ▶ Carry out action steps according to the illustration.
- ▷ PowerCool is deactivated.

SuperFrost

This function activates or deactivates SuperFrost. Activating SuperFrost the appliance increases the freezing capacity. This allows you to achieve lower freezer temperatures.

Application:

- Quickly freezing fresh food through to the core. This ensures that the nutrition value, look, and taste of the food is preserved.
- Increasing cold reserves in stored frozen food before defrosting the appliance.

If the function is active, the appliance operates at a higher output. As a result, the operating noise of the appliance may be temporarily louder, while energy consumption increases.

Activating SuperFrost

Make sure that the following requirements are fulfilled:

- The freezing volume and time for SuperFrost activation are taken into account. (see Freezing food using SuperFrost)



Fig. 32

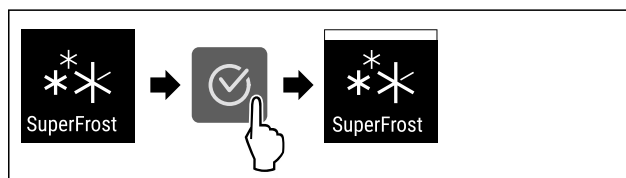

Fig. 33

- ▶ Carry out action steps according to the illustration.
- ▷ SuperFrost is activated.

Deactivating SuperFrost

SuperFrost is automatically deactivated after 56 to 72 hours depending on the volume of the stored food. However, you can also manually deactivate SuperFrost at any time:

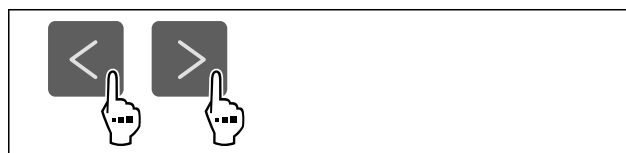
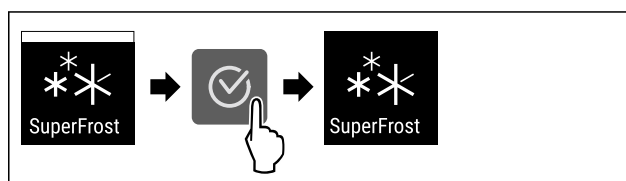

Fig. 34



Use

Fig. 35

- ▶ Carry out action steps according to the illustration.
- ▷ SuperFrost is deactivated.
- ▷ Appliance continues to run in normal operation.
- ▷ The appliance first cools to the set temperature.



Start defrost cycle

Use this function to start the automatic defrost cycle manually if the defrost cycle does not start automatically in case of an error.

Starting the defrost cycle

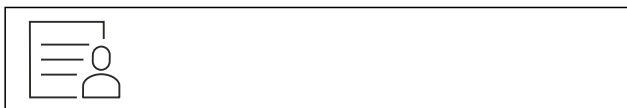

Fig. 36

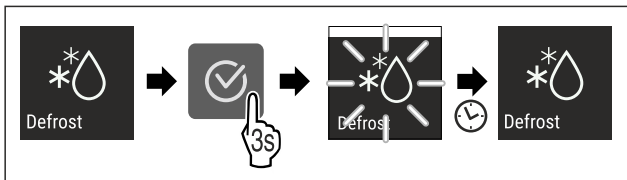

Fig. 37

- ▶ Carry out action steps according to the illustration.
- ▷ Defrost cycle has started: Symbol flashes until the defrost cycle is automatically completed.
- ▷ When the defrost cycle is completed: Appliance continues to run in normal operation.

Canceling the defrost cycle

The defrost cycle is automatically completed. However, you can also cancel the defrost cycle at any time during the defrosting:

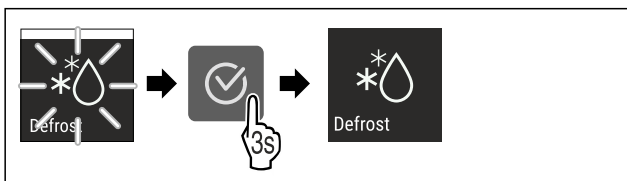

Fig. 38

- ▶ Carry out action steps according to the illustration.
- ▷ Defrost cycle is canceled.
- ▷ Appliance continues to run in normal operation.



PartyMode

This function activates and deactivates PartyMode. PartyMode activates different functions that are useful for a party.

PartyMode activates the following functions:

- SuperCool
- SuperFrost
- IceMaker (see IceMaker *) and MaxIce (see MaxIce*) *

You can set all listed functions individually and flexibly. By deactivating PartyMode all changes are discarded.

If the function is active, the appliance operates at a higher output. As a result, the operating noise of the appliance may be temporarily louder, while energy consumption increases.

Activating PartyMode

Make sure that the following requirements are fulfilled:*

- IceMaker has been started for the first time. (see 4.2 Starting the IceMaker for the first time*)



Fig. 39

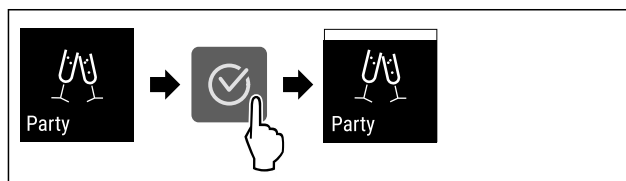

Fig. 40

- ▶ Carry out action steps according to the illustration.
- ▷ PartyMode and the corresponding functions are activated.
- ▷ The current temperature flashes until the target temperature is reached.

Deactivating PartyMode

PartyMode is automatically deactivated after 24 hours. However, you can also manually deactivate PartyMode at any time:



Fig. 41

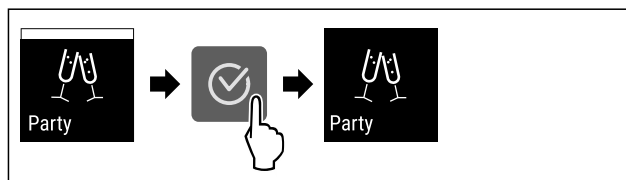

Fig. 42

- ▶ Carry out action steps according to the illustration.
- ▷ PartyMode is deactivated.
- ▷ The appliance first cools to the set temperature: The current temperature flashes until the target temperature is reached.



HolidayMode

Use this function to activate or deactivate HolidayMode. If you activate HolidayMode the fridge section is set to 15 °C (59 °F). This helps you save energy if you are away for a longer period of time and avoid bad smells and mold formation.

Appliance status with active HolidayMode
Fridge section cools to 15 °C (59 °F).
EasyFresh cools down to 15 °C (59 °F).
The set temperature is maintained in the freezer section.
PartyMode is deactivated.
SuperCool is deactivated.
PowerCool is deactivated.

Activating HolidayMode

- ▶ Empty the fridge section completely.
- ▶ Empty EasyFresh completely.

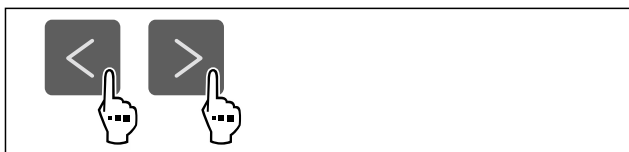

Fig. 43

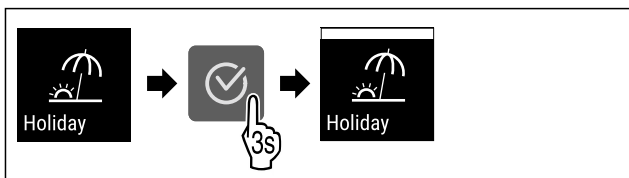

Fig. 44

- ▶ Carry out action steps according to the illustration.
- ▷ HolidayMode is activated.
- ▷ Temperature display shows the HolidayMode symbol.

Deactivating HolidayMode

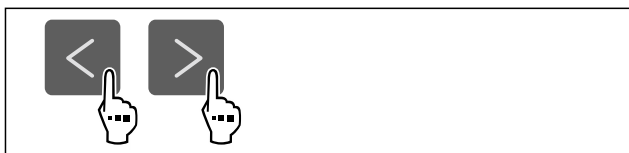

Fig. 45

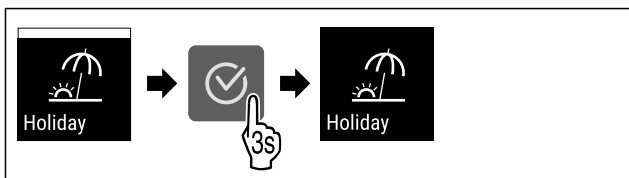

Fig. 46

- ▶ Carry out action steps according to the illustration.
- ▷ HolidayMode is deactivated.

- ▷ The appliance first cools to the set temperature.



SabbathMode

This function activates and deactivates SabbathMode. If you activate this function, some electronic functions are switched off. Your appliance thereby meets the religious requirements of Jewish holidays such as the Sabbath and complies with STAR-K Kosher certification.

Appliance status with active SabbathMode
The status display continuously shows SabbathMode.
All functions in the display except the Deactivating SabbathMode function are disabled.
Active functions remain active.
The display remains bright when you close the door.
The interior lighting is deactivated.
Memories are not listed. The set time interval is stopped.
Memories and warnings are not displayed.
There is no door alarm.
There is no temperature alarm.
The IceMaker is out of order.*
The defrost cycle operates only for the specified time without taking into account the appliance usage.
After a power failure, the device returns to SabbathMode.

Appliance status

Note

This appliance has certification from the "Institute for Science and Halacha". (www.machonhalacha.co.il)

You can find a list of STAR-K-certified appliances at www.star-k.org/appliances.

Activating SabbathMode



WARNING

Danger of poisoning from spoiled food!

If you have SabbathMode activated and a power failure occurs, no message appears in the status display about the power failure. Once the power is restored, the appliance continues to operate in SabbathMode. The power failure may mean that food spoils and the consumption of this food could lead to food poisoning. After a power failure:

- ▶ Do not consume food that has been frozen and thawed.

Use



Fig. 47

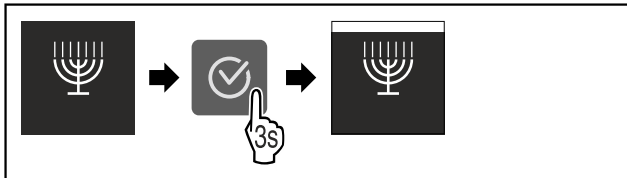

Fig. 48

- ▶ Carry out action steps according to the illustration.
- ▷ SabbathMode is activated.
- ▷ Status display continuously shows SabbathMode.

Deactivating SabbathMode

SabbathMode is automatically deactivated after 80 hours. However, you can also manually deactivate SabbathMode at any time:

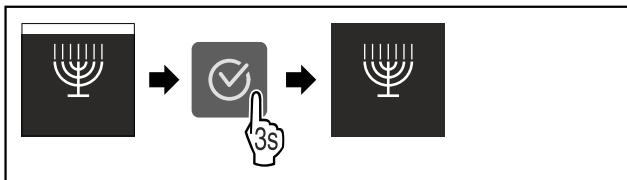

Fig. 49

- ▶ Carry out action steps according to the illustration.
- ▷ SabbathMode is deactivated.



E-Saver

Use this function to activate or deactivate energy saving mode. If you activate energy saving mode, energy consumption drops and the temperature in the appliance increases. Food remains fresh, but shelf life is reduced.

Temperature zone	Recommended setting (see Setting the temperature in the fridge section)	Temperature while E-Saver is active
5 °C Fridge section	4 °C (39 °F)	7 °C (45 °F)
-18 °C Freezer section	-18 °C (-0 °F)	-16 °C (3 °F)

Temperatures

Activating E-Saver



Fig. 50

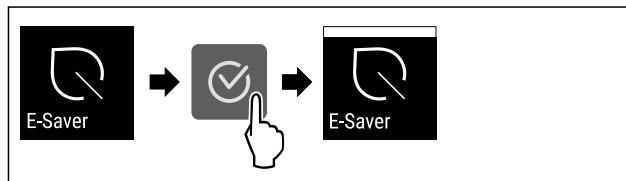

Fig. 51

- ▶ Carry out action steps according to the illustration.
- ▷ Energy saving mode is activated.

Deactivating E-Saver

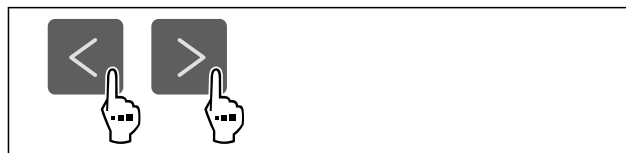

Fig. 52

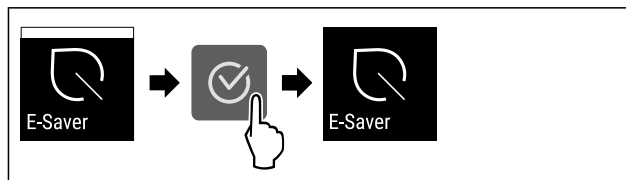

Fig. 53

- ▶ Carry out action steps according to the illustration.
- ▷ Energy saving mode is deactivated.



IceMaker *

You can activate or deactivate ice cube production with this function.

More information on the number of ice cubes:	(see 10.1 Technical specifications)
More information on increasing the number of ice cubes:	(see MaxIce*)
More information on the IceMaker water inflow:	(see IceMaker water inflow*)
More information on cleaning the lines of the IceMaker:	(see TubeClean *)

If the function is active, the appliance operates at a higher output. As a result, the operating noise of the appliance may be temporarily louder, while energy consumption increases.

Activating IceMaker

Make sure that the following requirements are fulfilled:

- ❑ The water supply is established at the fixed water connection. See Assembly Manual.*
- ❑ IceMaker is put into operation. (see 8.8 IceMaker*)



Fig. 54

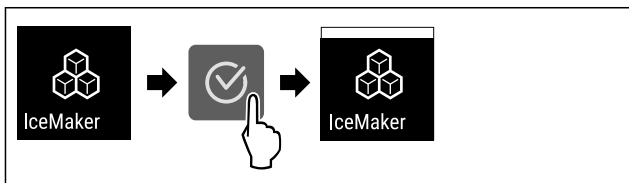

Fig. 55

- ▶ Carry out action steps according to the illustration.
- ▷ IceMaker is activated. It can take up to 24 hours for the IceMaker to produce the first ice cubes.

Deactivating IceMaker

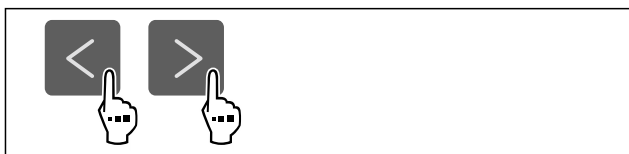

Fig. 56

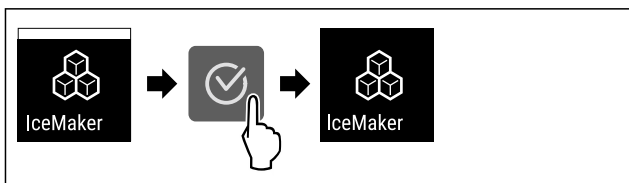

Fig. 57

- ▶ Carry out action steps according to the illustration.
- ▷ IceMaker is deactivated.
- ▷ If ice cubes are currently being made, the system completes the process.
- ▷ The IceMaker goes off automatically.

5 IceMaker water inflow*

Use this function to set the IceMaker water inflow. The IceMaker water inflow regulates the water inflow volume. You can adjust the IceMaker water inflow if the water inflow does not match the water pressure and the dispensed ice cube size.

Upon delivery, the IceMaker water inflow is set to the value 5. You can select a value of between 1 (smallest inflow volume) and 8 (largest inflow volume).

Setting the IceMaker-water inflow

Make sure that the following requirements are fulfilled:

- ❑ IceMaker has been started for the first time. (see 4.2 Starting the IceMaker for the first time*)
- ❑ IceMaker is activated. (see IceMaker *)

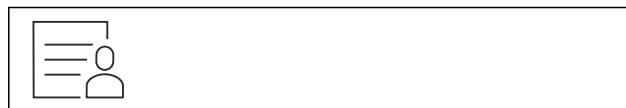

Fig. 58

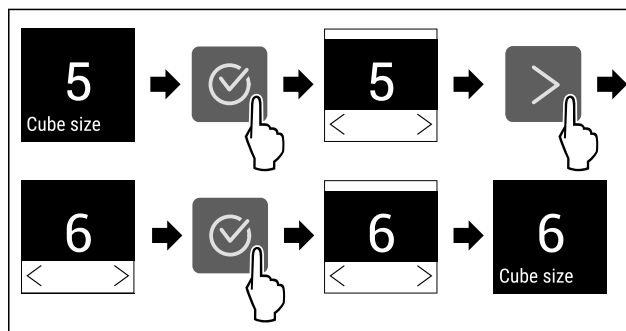

Fig. 59 Example illustration: Switching from value 5 to value 6.

- ▶ Carry out action steps according to the illustration.
- ▷ IceMaker water inflow is set.



MaxIce*

Use this function to increase the number of ice cubes in the IceMaker.

More information on the number of ice cubes:	(see 10.1 Technical specifications)
--	-------------------------------------

Activating MaxIce

If you activate MaxIce and have not previously activated the IceMaker (see IceMaker *) function, then by pressing MaxIce you can also automatically activate the IceMaker function.

If you have not yet activated the IceMaker function, make sure that the following requirements are met:

- ❑ The water supply is established at the fixed water connection. See Assembly Manual.*
- ❑ IceMaker is put into operation. (see 8.8 IceMaker*)

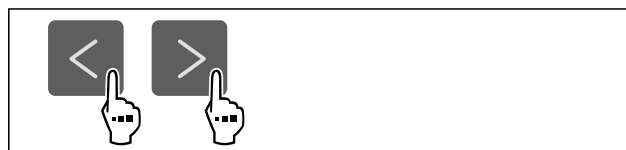

Fig. 60

Use

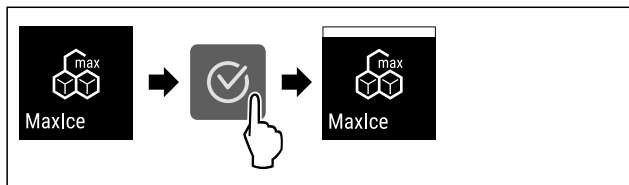

Fig. 61

- ▶ Carry out action steps according to the illustration.
- ▷ MaxIce is activated.
- ▷ If you have not activated the IceMaker function before: IceMaker is activated.

Deactivating MaxIce

If you deactivate MaxIce, then the IceMaker function is still activated.



Fig. 62

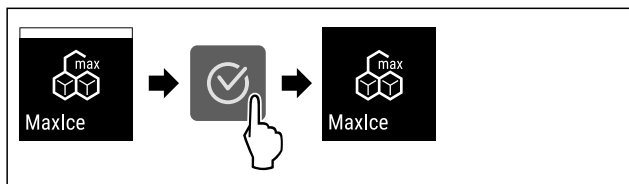

Fig. 63

- ▶ Carry out action steps according to the illustration.
- ▷ MaxIce is deactivated.

TubeClean *

This function activates or deactivates TubeClean. Activating TubeClean cleans the IceMaker lines.

Activating TubeClean

Make sure that the following requirements are fulfilled:

- IceMaker cleaning is prepared. (see 9.4.4 Cleaning the IceMaker*)
- Empty container with a capacity of 1.5 l (1.59 qt) and with a maximum height of 10 cm (3 15/16 in) is ready.

- ▶ Place the container into the drawer below the IceMaker.



Fig. 64

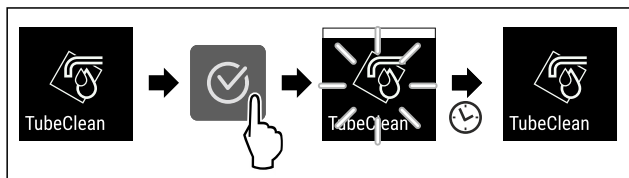

Fig. 65

- ▶ Carry out action steps according to the illustration.
- ▷ TubeClean is activated.
- ▷ Cleaning process has started: Symbol flashes until the cleaning process is automatically completed after 60 minutes.
- ▷ When the cleaning process is completed: Appliance continues to run in normal operation.

Deactivating TubeClean

TubeClean is automatically completed after 60 minutes. However, you can also deactivate TubeClean at any time during the cleaning process:

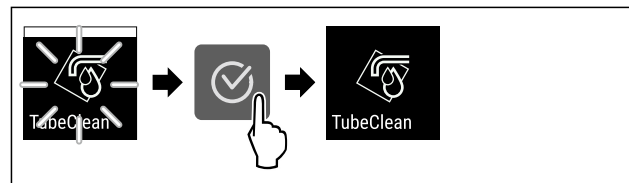

Fig. 66

- ▶ Carry out action steps according to the illustration.
- ▷ TubeClean is deactivated: Cleaning process is canceled.
- ▷ Appliance continues to run in normal operation.

CleaningMode

This function activates and deactivates CleaningMode. CleaningMode enables you to comfortably clean the appliance.

This setting relates to the fridge compartment.

Application:

- Clean the fridge compartment. (see 9.4 Cleaning the appliance)

Appliance status with active CleaningMode
The status display continuously shows CleaningMode.
The fridge section is switched off.
The interior lighting is activated.
Reminders and warnings are not displayed. No signal tone is sounded.

Appliance status

Activating CleaningMode

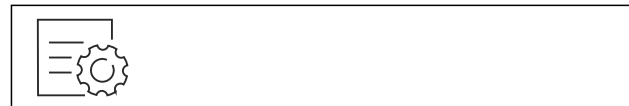

Fig. 67

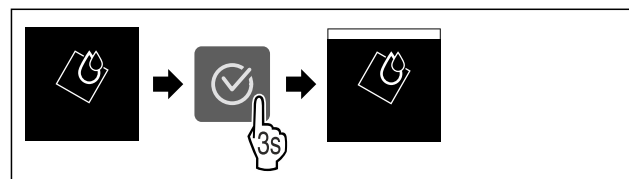

Fig. 68

- ▶ Carry out action steps according to the illustration.
- ▷ CleaningMode is activated.
- ▷ Status display continuously shows CleaningMode.

Deactivating CleaningMode

CleaningMode is automatically deactivated after 60 minutes. However, you can also manually deactivate CleaningMode at any time:

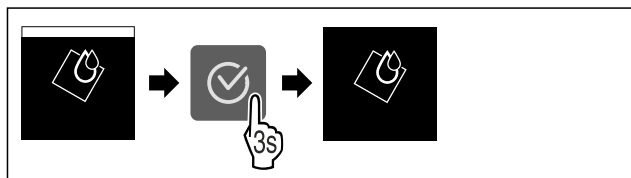

Fig. 69

- ▶ Carry out action steps according to the illustration.
- ▷ CleaningMode is deactivated.
- ▷ The appliance first cools to the set temperature.

Display Brightness

Use this function to set the brightness of the display gradually.

You can set the following brightness levels:

- 40 %
- 60 %
- 80 %
- 100% (default setting)

Setting the brightness

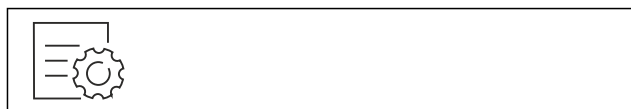

Fig. 70

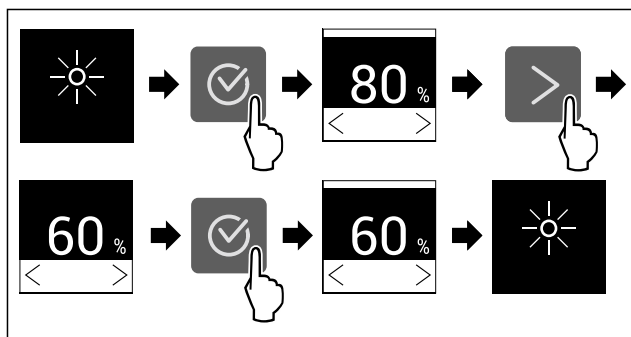

Fig. 71 Example illustration: Switching from 80 % to 60 %.

- ▶ Carry out action steps according to the illustration.
- ▷ Brightness is set.

Door alarm

Use this function to activate or deactivate the door alarm. The door alarm sounds if the door is open for too long. The door alarm is activated upon delivery. You can set how long the door can remain open until the door alarm sounds.

You can set the following values:

- 1 minute
- 2 minutes
- 3 minutes
- Off

Setting the door alarm



Fig. 72

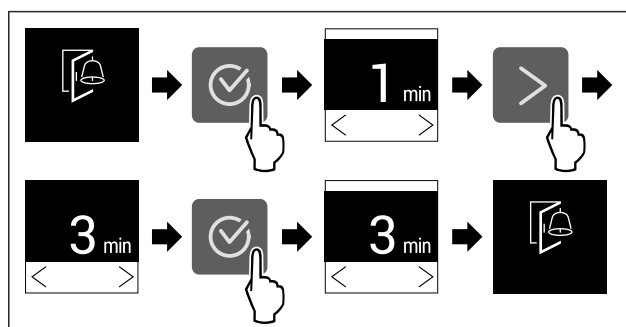

Fig. 73 Example illustration: Changing the door alarm from 1 minute to 3 minutes.

- ▶ Carry out action steps according to the illustration.
- ▷ Door alarm is set.

Deactivating door alarm



Fig. 75

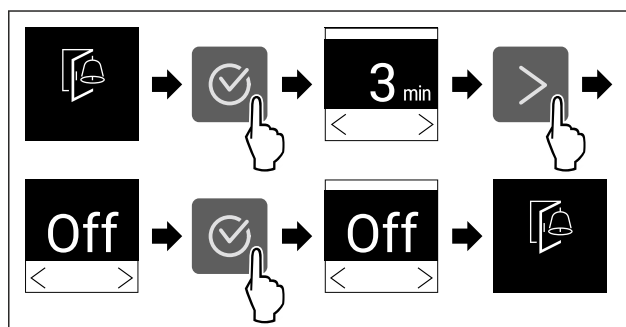

Fig. 76

- ▶ Carry out action steps according to the illustration.
- ▷ Door alarm is deactivated.

Use



Input lock

This function activates and deactivates the input lock. The input lock prevents the appliance from being operated accidentally, e. g. by children.

Application:

- Prevent unintentional changes of functions.
- Prevent switching off of the appliance.
- Prevent unintentional temperature setting.

Activating the input lock

If you activate the input lock, you can continue to navigate in the menus, however you cannot select or modify other functions.



Fig. 77

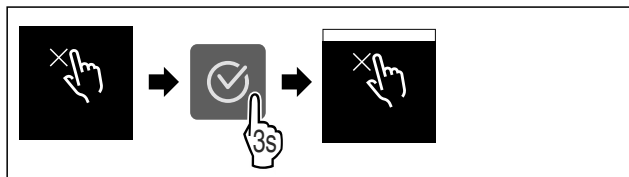

Fig. 78

- ▶ Carry out action steps according to the illustration.
- ▷ Input lock is activated.

Deactivating the input lock

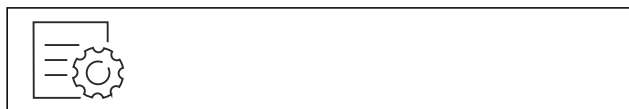

Fig. 79

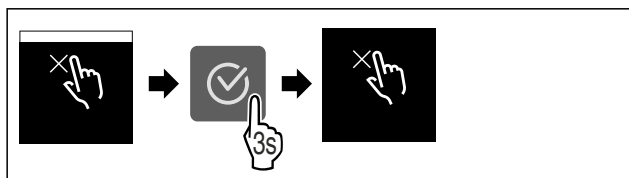

Fig. 80

- ▶ Carry out action steps according to the illustration.
- ▷ Input lock is deactivated.



Appliance information

Use this function to display the model name, index, serial number and service number of your appliance. You will need the appliance information when you contact customer service. (see 10.4 Customer Service)

You also use this function to open the expanded menu. (see 3 Functionality of the Touch display)

Display appliance information



Fig. 81



Fig. 82

- ▶ Carry out action steps according to the illustration.
- ▷ Display shows the appliance information.



Software

Use this function to display the software version of your appliance.

Display software version



Fig. 83



Fig. 84

- ▶ Carry out action steps according to the illustration.
- ▷ Display indicates the software version.



Reminder

Use this function to activate or deactivate reminder. This function is activated upon delivery.

The following reminders will then appear if the function is activated:

- Replace the FreshAir activated charcoal filter (see Replace FreshAir activated charcoal filter)

Activating reminder



Fig. 85

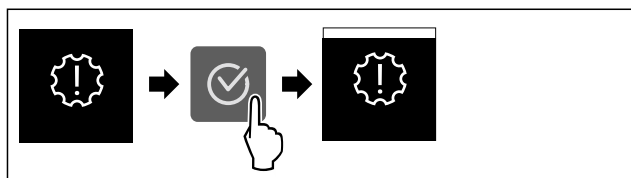

Fig. 86

- ▶ Carry out action steps according to the illustration.
- ▷ Reminder is activated.

Deactivating reminder



Fig. 87

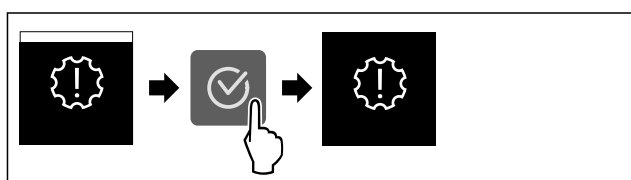

Fig. 88

- ▶ Carry out action steps according to the illustration.
- ▷ Reminder is deactivated.

Demo mode

Demo mode is a special feature for dealers who want to demonstrate appliance features. If you activate demo mode, all refrigeration functions are deactivated. If you switch on your appliance and “Demo” appears in the status display, then demo mode is already activated.

If you activate and then deactivate demo mode, the appliance will be reset to factory defaults. (see Resetting to factory settings)

Activating demo mode



Fig. 89

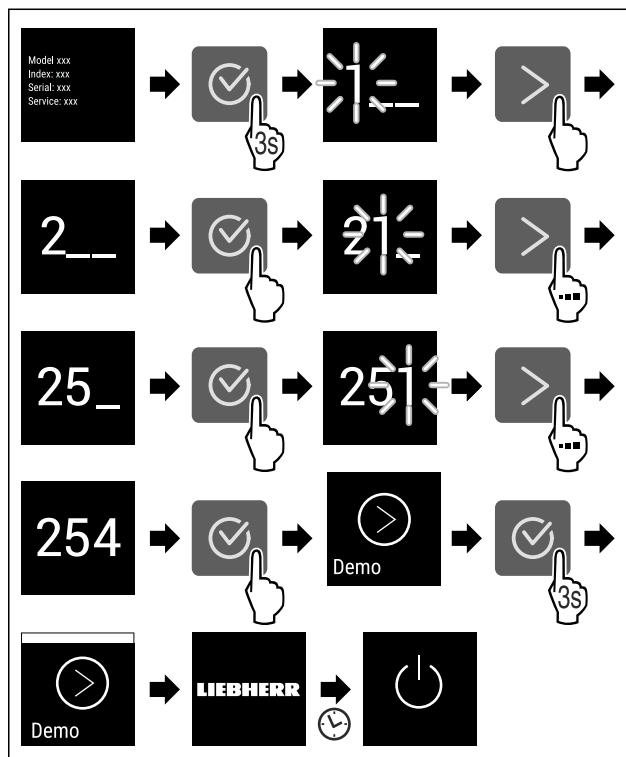

Fig. 90

- ▶ Carry out action steps according to the illustration.
- ▷ Demo mode is activated.
- ▷ Appliance is switched off.
- ▶ Switch on the appliance. (see 4.1 Switching on appliance (first use))
- ▷ “DEMO” appears in the status display.

Deactivating demo mode



Fig. 91

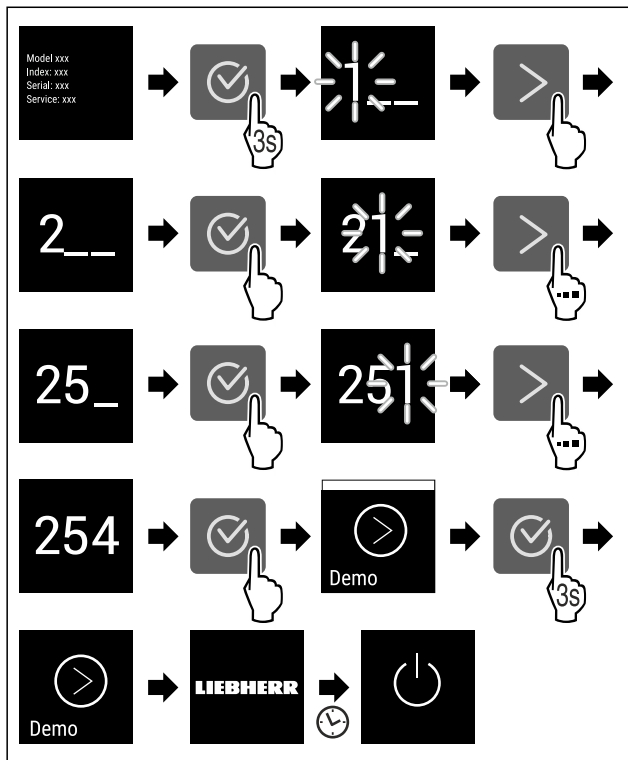

Fig. 92

- ▶ Carry out action steps according to the illustration.
- ▷ Demo mode is deactivated.
- ▷ Appliance is switched off.
- ▶ Switch on the appliance. (see 4.1 Switching on appliance (first use))
- ▷ Appliance is reset to factory settings.

Resetting to factory settings

Use this function to reset all settings to factory settings. All settings you have made so far are reset to their original settings.

Performing a reset



Fig. 93

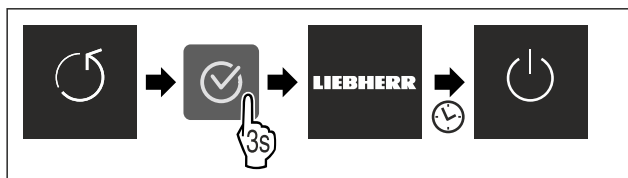

Fig. 94

- ▶ Carry out action steps according to the illustration.
- ▷ Appliance is reset.
- ▷ Appliance is switched off.
- ▶ Restart the appliance. (see 4.1 Switching on appliance (first use))

7.3 Messages



There are two categories of messages:

Category	Meaning
Warning	Warnings are displayed if there is a door alarm or a malfunction. You can easily end warnings yourself. For any major malfunction, you must contact Customer Service. (see 10.4 Customer Service)
Reminder	Reminders remind you of general processes. You can perform these processes and end the message doing so.

7.3.1 Overview of warnings

The appliance's behavior in the event of a warning:

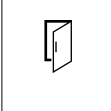
- Warning appears in the display.
- Alarm sounds in increasing volume.
- For some warnings the interior lighting pulses.

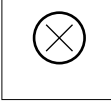
Message	Cause	Ending the message
 Door alarm	The message appears if the door is open for too long.	Carry out action steps (see Door alarm) .
 Power failure alarm	The message appears if the freezing temperature increases due to a power outage.	Carry out action steps (see Power failure alarm) .
 Temperature alarm	The message appears if the freezing temperature does not correspond to the set temperature.	Carry out action steps (see Temperature alarm) .
 Error	This message appears if there is an appliance error. An appliance module indicates an error.	Carry out action steps (see Error) .

7.3.2 Ending warnings

Door alarm

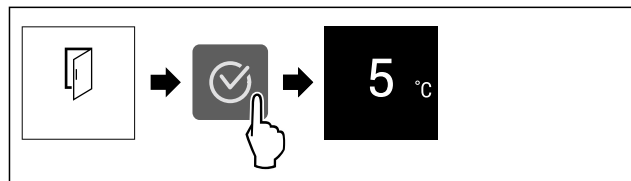

Fig. 95 Example illustration

► Carry out action steps according to the illustration.

-or-

► Close the door.

▷ Display skips to status display.

You can set how long to door may remain open until the door alarm sounds. (see Setting the door alarm)

Power failure alarm

Once the power failure has ended, the appliance cools to the target temperature set earlier.

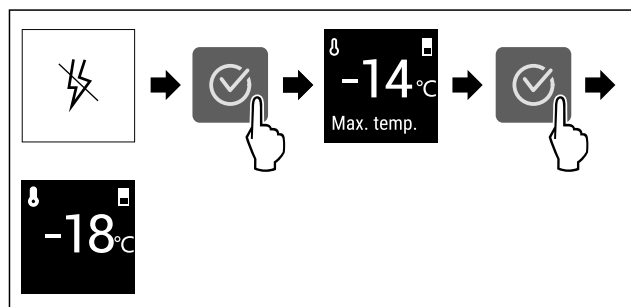

Fig. 96 Example illustration

► Press the Confirm symbol.

▷ The warmest freezing temperature is displayed.

▷ If the freezing temperature was below -9 °C (16 °F): Food can still be eaten.

If the freezing temperature exceeded -9 °C (16 °F):

► Check the food.

► Press the Confirm symbol.

▷ Display skips to status display: The current temperature and target temperature are displayed.

Temperature alarm

Causes for the temperature differences may be:

- You have put in warm, fresh food.
- Too much warm room air has flowed in during the rearrangement and removal of food.
- The power has been out for a longer period of time.
- The appliance is defective.

► Remedy the cause.

▷ The appliance cools to the target temperature set earlier:

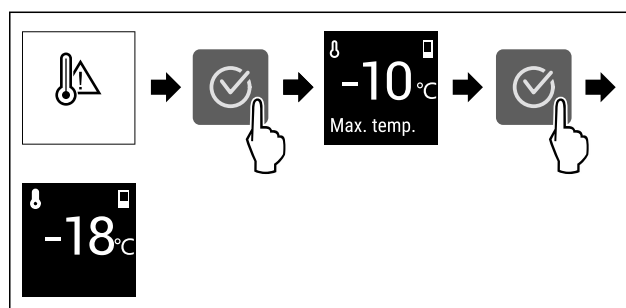

Fig. 97 Example illustration

► Press the Confirm symbol.

▷ The warmest freezing temperature is displayed.

▷ If the freezing temperature was below -9 °C (16 °F): Food can still be eaten.

If the freezing temperature exceeded -9 °C (16 °F):

► Check the food.

► Press the Confirm symbol.

▷ Display skips to status display: The current temperature and target temperature are displayed.

Error

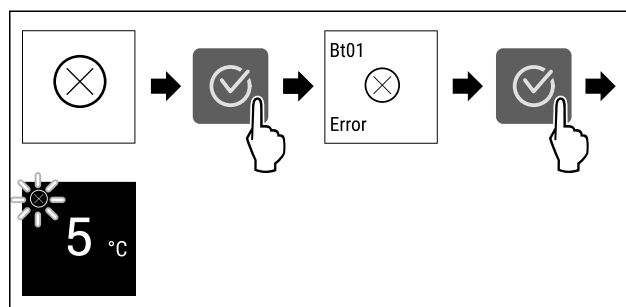

Fig. 98 Example illustration

► Press the Confirm symbol.

▷ Error code is displayed.

► Make a note of the error code.

► Press the Confirm symbol.

▷ Display skips to status display.

► Contact Customer Service. (see 10.4 Customer Service)

7.3.3 Overview of reminders

The appliance's behavior in the event of a reminders:

- Reminder appears in the display.
- Alarm tone sounds.
- For some reminders the interior lighting pulses.

Message	Cause	Ending the message
 IceMaker * Push in the IceMaker drawer*	This message appears if the IceMaker is active, but the IceMaker drawer is open.*	Carry out action steps (see Push in the IceMaker drawer*).*

Equipment

Message	Cause	Ending message
 <p>Replace the FreshAir activated charcoal filter</p>	This message appears if you have to replace the activated charcoal filter.	Carry out action steps (see Replace activated charcoal filter).

7.3.4 Ending reminders

Push in the IceMaker drawer*

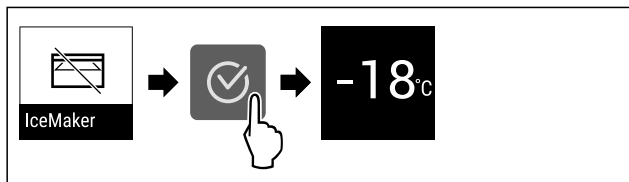

Fig. 99 Example illustration

- ▶ Press the Confirm symbol.
 - ▶ Push in the IceMaker drawer.
- or-**
- ▶ Deactivate IceMaker. (see IceMaker *)
- ▷ If the IceMaker drawer is pushed in and IceMaker is active: IceMaker is producing ice cubes.

Replace FreshAir activated charcoal filter

Liebherr recommends: Replace the FreshAir activated charcoal filter every 6 months.

Note

FreshAir activated charcoal filters can be purchased from the Liebherr Service Center. The address for your respective country can be found on the back of the instructions.

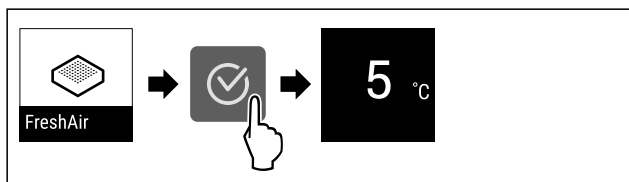

Fig. 100 Example illustration

- ▶ Press the Confirm symbol.
 - ▶ Replace activated charcoal filter. (see 9.1 FreshAir carbon filter)
- ▷ The activated charcoal filter ensures optimum air quality in the refrigerator.
- ▷ Reminder appears again after 6 months.
- If you no longer want to keep this reminder, you can deactivate the reminder. (see Deactivating reminder)

8 Equipment

8.1 Door racks

8.1.1 Moving/removing door racks

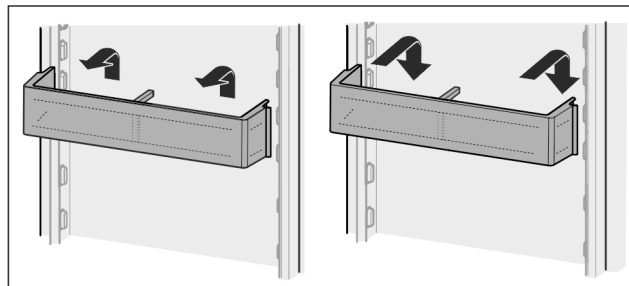

Fig. 101

- ▶ Slide racks up.
- ▶ Pull to the front.
- ▶ Re-insert in reverse order.

8.1.2 To dismantle door racks

The door racks can be disassembled for cleaning.

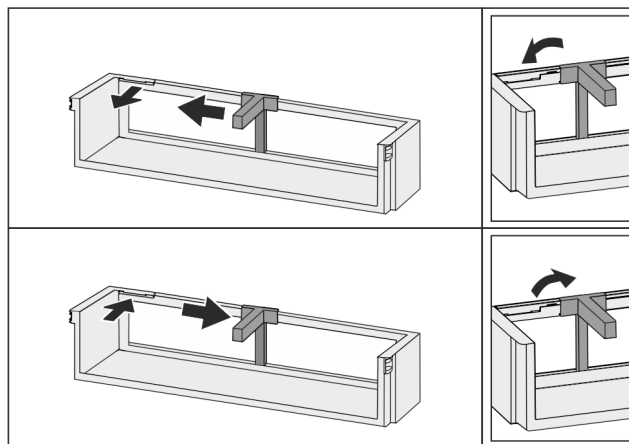

Fig. 102

- ▶ Disassemble the door racks.

8.2 Shelves

8.2.1 Moving/removing shelves



CAUTION

Broken shelves!
Danger of cuts.

- ▶ Only remove storage shelves when there is nothing on them

Extension stops secure the shelves against being accidentally pulled out

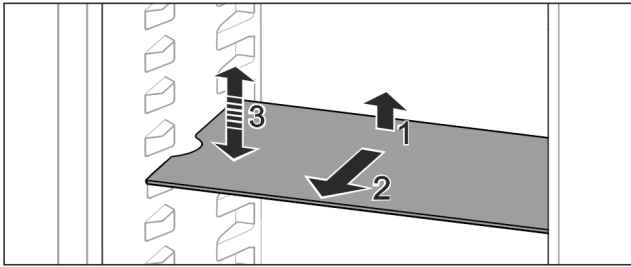

Fig. 103

- ▶ Lift the shelf and pull to the front.
- ▷ Side recess to shelf position.
- ▶ Reposition the shelf: Lift up or lower to the desired height and insert.

-or-

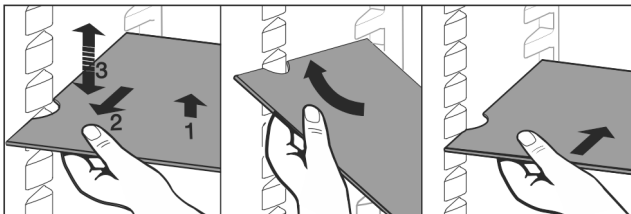

Fig. 104

- ▶ Take out the shelf completely: Pull out to the front.
- ▶ Easier removal: Set the shelf at an angle.
- ▶ Reinsert the shelf: Push it in to its stop limit.
- ▷ Pull-out stoppers are pointing down.
- ▷ Pull-out stoppers are behind the front shelf.

You can also remove the shelf above the EasyFresh compartments.

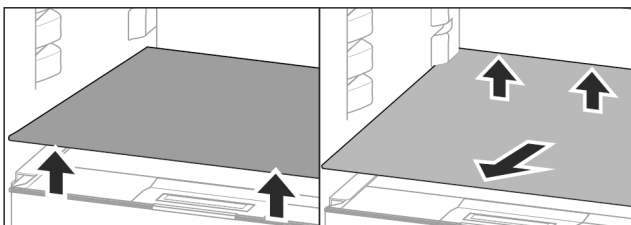

Fig. 105

To remove shelf

- ▶ Lift the shelf at the front and back.*
- ▶ Remove from the front.

Do not place any goods on the drawer cover below!

Slide the shelf in:

- ▶ Place the shelf at an angle, with the back tilted downwards.
- ▷ Pull-out stoppers are pointing down.
- ▶ Slide the shelf into place.

8.2.2 Dismantling shelves

The shelves can be dismantled for cleaning.

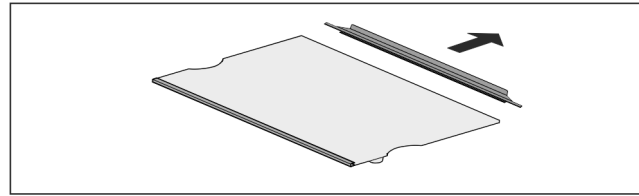

Fig. 106

- ▶ Disassemble the shelf.

8.3 Space for baking tray

There is space for a baking tray Fig. 1 (4) above the drawers.

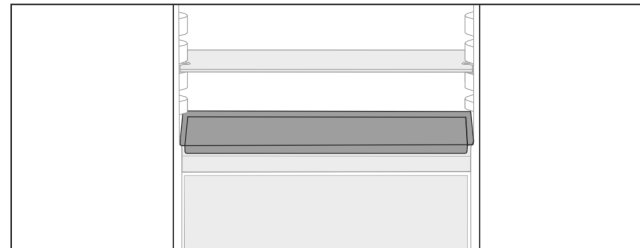

Fig. 107

Make sure that the following requirements are fulfilled

- Max. baking tray dimensions are adhered to (see 10.1 Technical specifications).
- Baking tray has cooled to room temperature.
- The bottom door stopper is set at least one position up.

When door 90° is open:

- ▶ Slide the baking tray onto the lower side runs.

8.4 Drawers

You can remove the drawers for cleaning.

You can remove the drawers to use VarioSpace.

The way to remove/insert the drawers varies depending on the pull-out system. Your appliance can contain a variety of pull-out systems.

Note

Insufficient ventilation results in an increase in energy consumption and reduction of the refrigerating performance.

- ▶ Leave the bottom drawer in appliance!
- ▶ Never obstruct the vents on the interior rear wall!

8.4.1 Drawer on appliance base or glass shelf

The drawer runs directly on the appliance base or on a glass shelf. There are no rails.

When you remove the drawers, you can use the glass shelves below them as storage shelves.

Equipment

Removing drawer

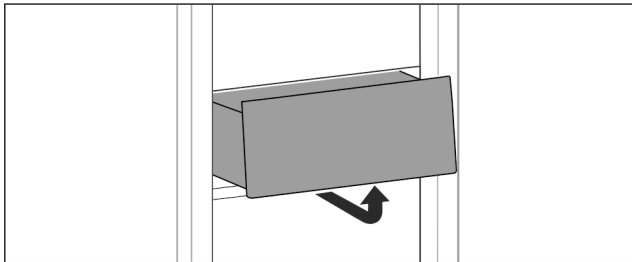

Fig. 108

- ▶ Remove drawer as shown in the diagram.

Inserting drawer

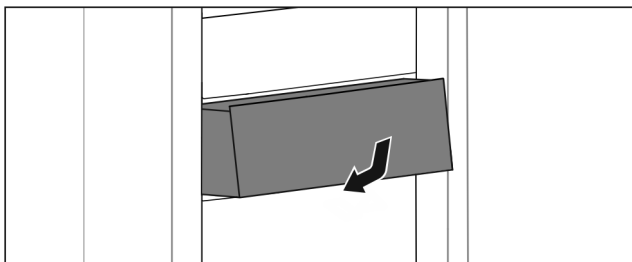

Fig. 109

- ▶ Insert drawer as shown in the diagram.

8.4.2 Drawer on glide rails

Removing drawer

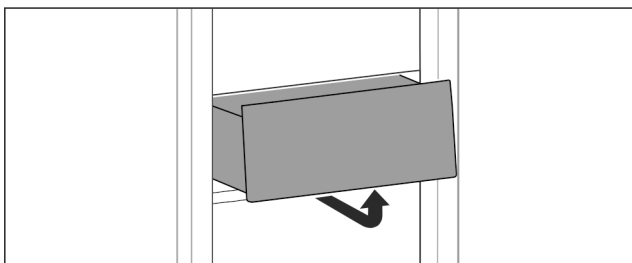

Fig. 110

- ▶ Remove drawer as shown in the diagram.

Inserting drawer

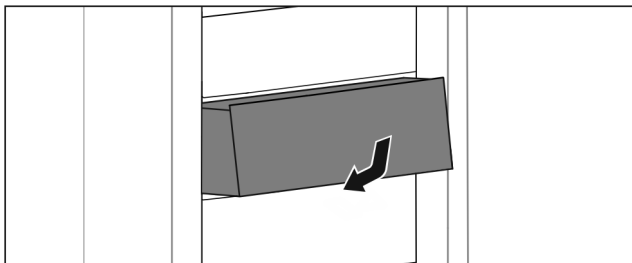

Fig. 111

- ▶ Insert drawer as shown in the diagram.

8.4.3 Drawer on telescopic rails

The drawer runs on full-extension rails (telescopic rails). There are full-extension telescopic rails and telescopic rails with partial pull-out. Drawers which are full extension can be pulled out fully from the appliance. Drawers with partial pull-out cannot be pulled out fully from the appliance. The system in your appliance depends on the type of appliance.

Full extension*

If you have full-extension rails, there is a clamp located at the back on the left and right of the rail.

Removing drawer

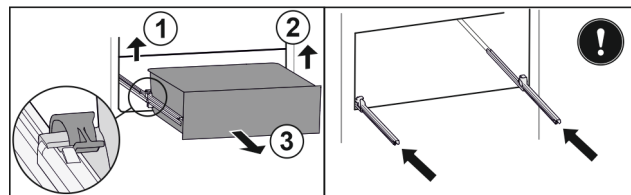

Fig. 112

- ▶ Pull out drawer as far as it will go.
- ▶ Lift left clamp and simultaneously pull drawer forwards on the left. Fig. 112 (1)
- ▶ Lift right clamp and simultaneously pull drawer forwards on the right. Fig. 112 (2)
- ▶ Remove drawer to the front. Fig. 112 (3)
- ▶ Slide rails in.

Inserting drawer

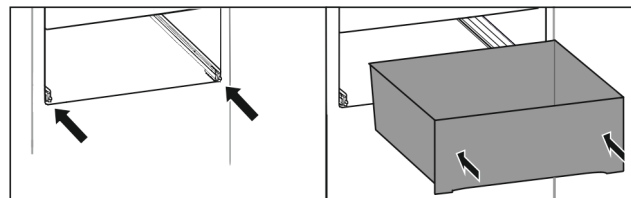

Fig. 113

- ▶ Slide rails in.
- ▶ Place drawer on rails.
- ▶ Slide in drawer to the back.
- ▷ Drawer latches in audibly at the back.

Partial pull-out fridge compartment*

Removing drawer

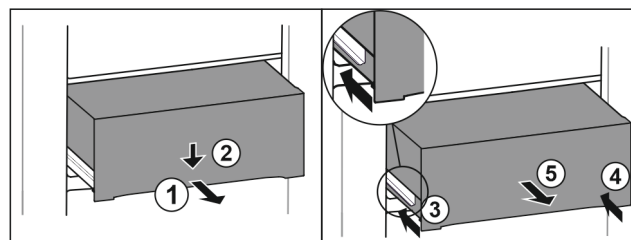

Fig. 114

- ▶ Pull out the drawer halfway. Fig. 114 (1)
- ▶ Press down the drawer on the front. Fig. 114 (2)
- ▶ Push in the left rail approximately 2 cm (13/16 in). Fig. 114 (3)

- ▶ Push in the right rail approximately 2 cm (13/16 in). *Fig. 114 (4)*
- ▶ Remove drawer to the front. *Fig. 114 (5)*

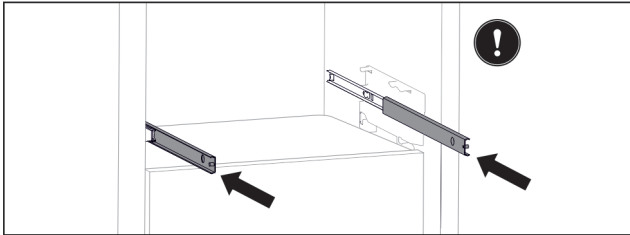

Fig. 115

If the rails are not yet fully pushed in after removing the drawer:

- ▶ Push the rails in completely.

Inserting drawer

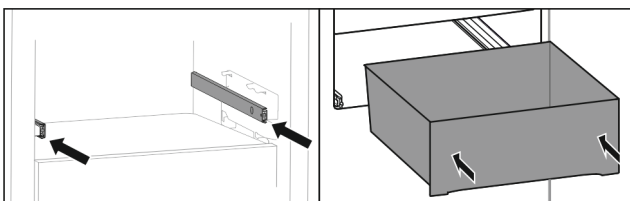

Fig. 116

- ▶ Slide rails in.
- ▶ Place drawer on rails.
- ▶ Slide in drawer to the back.

8.5 EasyFresh-Safe

The compartment lid can be removed for cleaning.

8.5.1 Removing the compartment lid

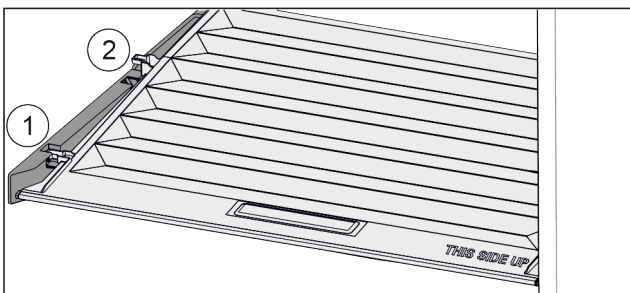

Fig. 117

If the drawers are removed:

- ▶ Pull the lid up at the front in the retaining parts to the opening *Fig. 117 (1)*.
- ▶ Lift from the back and pull it up and out *Fig. 117 (2)*.

8.5.2 Inserting the compartment lid

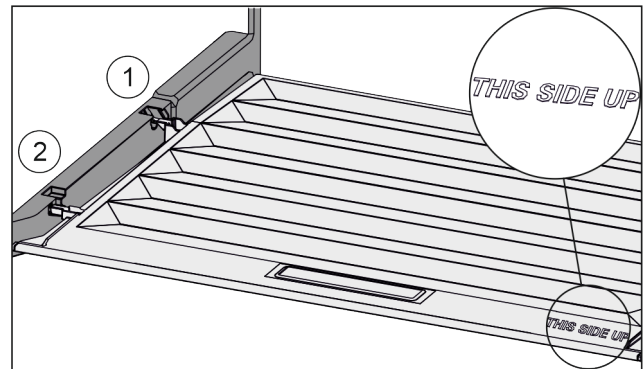

Fig. 118

If the text THIS SIDE UP is on top:

- ▶ Insert the lip of the cover over the opening of the rear bracket *Fig. 118 (1)* and click into place *Fig. 118 (2)*.
- ▶ Position the cover where you want it (see 8.6 Humidity control).

8.6 Humidity control

You can regulate the moisture in the drawer yourself by adjusting the compartment cover.

The compartment cover is on the drawer itself and can be covered with shelves or additional drawers.

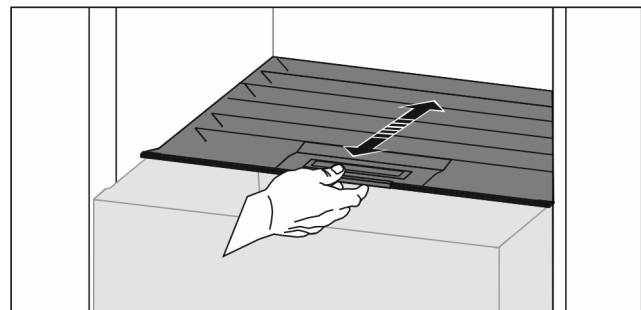

Fig. 119

Low air humidity

- ▶ Open the drawer.
- ▶ Pull the drawer cover to the front.
- ▷ If the drawer is closed: Gap between lid and compartment.
- ▷ Moisture levels lower in the Safe.

High air moisture:

- ▶ Open the drawer.
- ▶ Slide the compartment cover to the back.
- ▷ If the drawer is closed: The cover seals the compartment.
- ▷ Moisture levels rise in the Safe.
- If there is too much moisture in the compartment:
 - ▶ Choose a "low moisture setting".
 - or-
 - ▶ Remove the moisture with a cloth.

Equipment

8.7 Glass shelves

You can remove the glass shelf under the drawers for cleaning.

You can remove the glass shelf under the drawers to use VarioSpace.

8.7.1 Removing / inserting the glass shelf

Make sure that the following requirements are fulfilled:

- ❑ Glass shelf under the drawer: Drawer has been removed. (see 8.4 Drawers)

Removing glass shelf

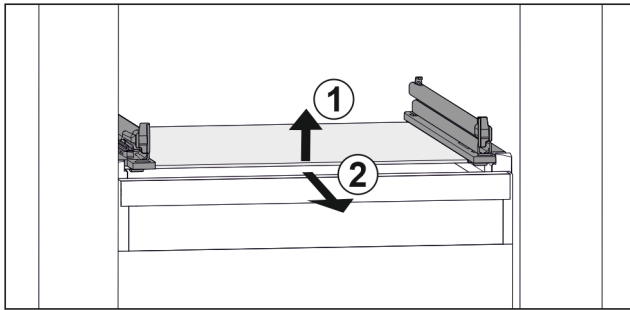

Fig. 120 Example illustration of glass shelf

- ▶ Lift glass shelf at the front. Fig. 120 (1)
- ▶ Remove glass shelf to the front. Fig. 120 (2)

Inserting the glass shelf

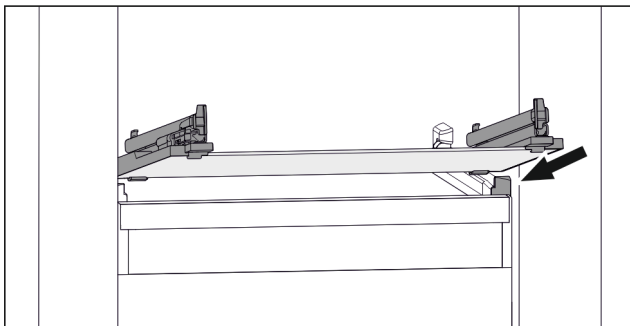

Fig. 121 Example illustration of glass shelf

- ▶ Position glass shelf at an angle behind the stoppers. (see Fig. 121)
- ▶ Lower glass shelf.
- ▶ Slide in glass shelf to the back.

8.8 IceMaker*

The IceMaker is used exclusively for the production of ice cubes in household quantities.

Make sure that the following conditions are fulfilled

- IceMaker is cleaned. (see 9 Maintenance)
- IceMaker drawer is cleaned.
- IceMaker drawer is fully inserted.

8.8.1 Producing ice cubes

The production capacity depends on the freezer temperature. The lower the temperature, the more ice cubes can be produced in a certain period.

Once IceMaker is switched on for the first time, it can take up to 24 hours to produce the first ice cubes.

- ▶ Activate the IceMaker function.
- ▶ Making many ice cubes: Activate the MaxIce function.
- ▶ To make a large quantity of ice cubes: Move or remove the separators in the IceMaker drawer.*
- ▶ Distribute ice cubes evenly in the drawer to increase its capacity.
- ▶ Close the drawer: The IceMaker starts making ice again.

Note

When a certain level is reached in the IceMaker drawer, it stops making ice cubes. The IceMaker does not fill the drawer to the very top.

8.8.2 Using the drawer with the IceMaker deactivated

If you deactivate the IceMaker, then you can use the entire IceMaker drawer as a freezer drawer.

- ▶ Deactivate IceMaker. (see Deactivating IceMaker)

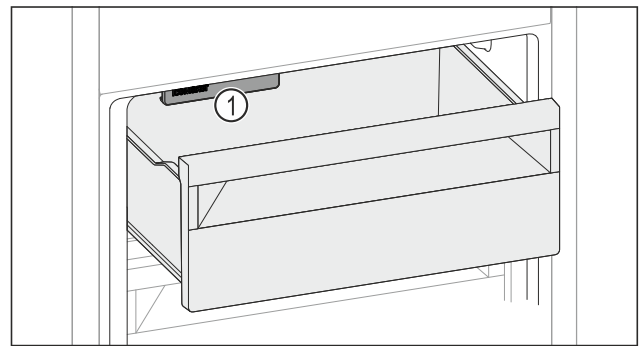

Fig. 122

- ▶ Place food in drawer.
If you put food in the left side of the drawer:
- ▶ Pay attention to the IceMaker Fig. 122 (1).

8.9 VarioSpace

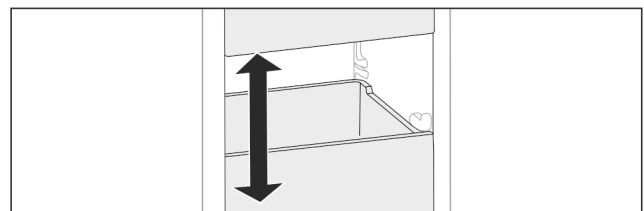

Fig. 123

You can remove drawers and glass panels from your appliance. This provides more room for large food items such as poultry, joints of meat, large game and bulky baked goods. You can then freeze these items whole for later preparation.

- ▶ Note the load limits on the drawers and glass panels (see 10.1 Technical specifications).

8.10 Bottle rack

8.10.1 Using the bottle rack

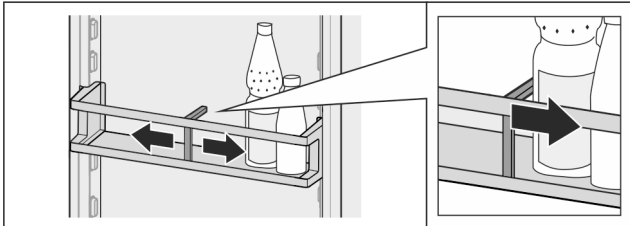

Fig. 124

- ▶ Slide the bottle rack at the edges.
- ▷ Stops bottles from tipping over.

8.10.2 Removing the bottle rack

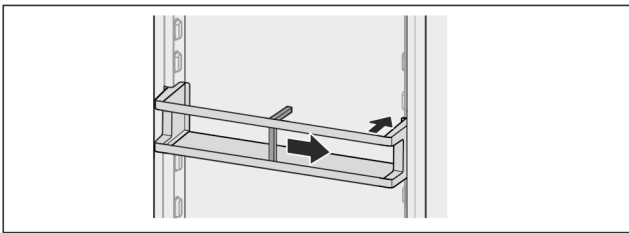

Fig. 125

- ▶ Slide the bottle rack all the way to the right edge.
- ▶ Remove to the back.

8.11 Flexible ice compartment divider*

The IceMaker's ice cube drawer has a flexible ice compartment divider. This allows you to store larger quantities of ice cubes or additional food items as needed. You can move or remove the ice compartment divider.

8.11.1 Moving the flexible ice compartment divider

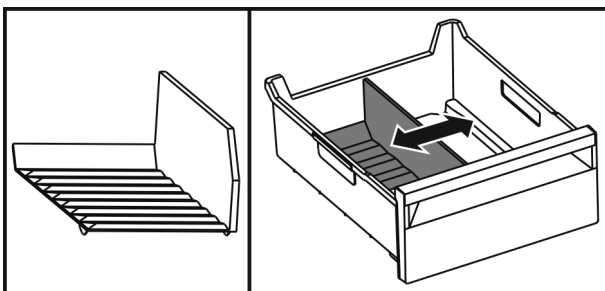

- ▶ Move the ice compartment divider to the desired position.

8.11.2 Removing the flexible ice compartment divider

Make sure that the following requirements are fulfilled:

- ☐ Ice cube drawer is removed. (see 8.4 Drawers)

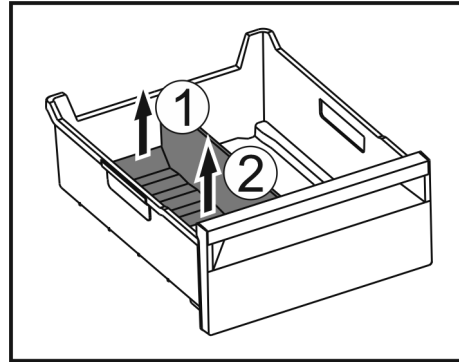

Fig. 127

- ▶ Lift the rear part of the ice compartment divider. Fig. 127 (1)
- ▶ Remove the ice compartment divider upwards. Fig. 127 (2)

8.11.3 Putting in the flexible ice compartment divider

Make sure that the following requirements are fulfilled:

- ☐ Ice cube drawer is removed. (see 8.4 Drawers)

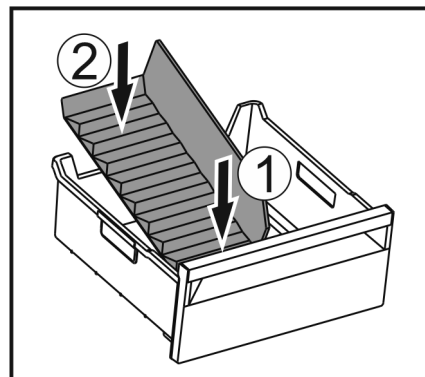

Fig. 128

- ▶ Insert the front part of the ice compartment divider. Fig. 128 (1)
- ▶ Lower the rear part of the ice compartment divider to the drawer bottom. Fig. 128 (2)

9 Maintenance

9.1 FreshAir carbon filter

The FreshAir carbon filter is located in the compartment above the fan.

Maintenance

It guarantees the best air quality.

- ❑ Change the carbon filter every 6 months.
When the reminder is set, a message on the display prompts you to change it.
- ❑ You can dispose of the carbon filter with the regular household waste.

Note

FreshAir activated charcoal filters can be purchased from the Liebherr Service Center. The address for your respective country can be found on the back of the instructions.

9.1.1 Removing the FreshAir carbon filter

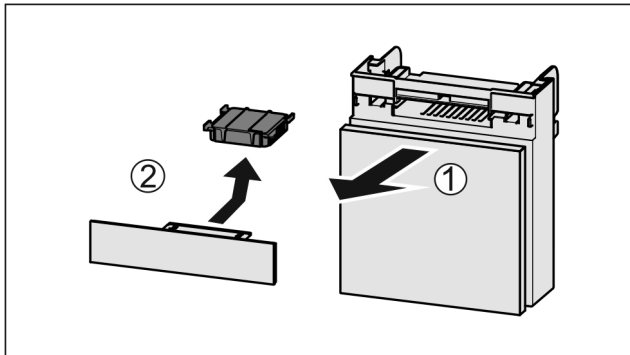

Fig. 129

- ▶ Pull out the compartment Fig. 129 (1).
- ▶ Remove the carbon filter Fig. 129 (2).

9.1.2 Inserting the FreshAir carbon filter

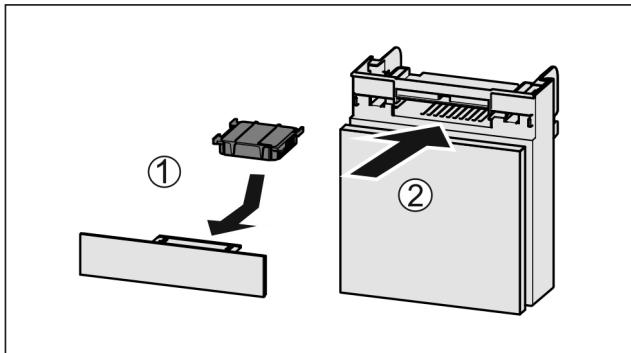

Fig. 130

- ▶ Insert the carbon filter as shown in the diagram Fig. 130 (1).
 - ▷ The carbon filter clicks into place.
 - ▷ If the carbon filter is pointing downwards:
- ▶ Push the compartment in Fig. 130 (2).
- ▷ The carbon filter is now ready for use.

9.2 Disassembling / assembling pull-out systems

9.2.1 Notes on disassembly

You can disassemble some of the pull-out systems for cleaning. Your appliance can contain a variety of pull-out systems.

The following pull-out systems can be disassembled or cannot be disassembled:

Pull-out system	can be disassembled / cannot be disassembled
Drawer on appliance base or glass shelf	cannot be disassembled
Drawer on glide rails	cannot be disassembled
Full extension*	cannot be disassembled*
Partial pull-out fridge compartment*	cannot be disassembled*

9.3 Defrosting the appliance

9.3.1 Defrosting the refrigerator compartment

Defrosting is performed automatically. The water from the thawing process runs out via the drain opening and is evaporated.

Water droplets or a thin layer of frost or ice can form on the rear wall; this is a completely normal part of the appliance's function. You do not have to remove them.

A frost or ice layer may form briefly due to the energy-optimized control of the appliance.

- ▶ Clean the drain hole regularly. (see 9.4 Cleaning the appliance)

9.3.2 Defrosting the freezer compartment with NoFrost

Defrosting is performed automatically by the NoFrost system. The moisture condenses on the evaporator and is periodically defrosted and evaporated.

The appliance does not need to be defrosted.

9.4 Cleaning the appliance

9.4.1 Preparation



WARNING

Danger of electric shock.

- ▶ Unplug refrigerator or disconnect power.



WARNING

Danger of fire

- ▶ Do not damage the refrigerant circuit.

- ▶ Empty appliance.
- ▶ Pull out the power plug.

-or-

- ▶ Activate CleaningMode. (see CleaningMode)

9.4.2 Cleaning the interior

NOTICE

Improper cleaning!
Damage to the appliance.

- ▶ Only use soft cleaning cloths and ph-neutral all-purpose cleaners.
- ▶ Do not use steel wool or sponges that scour or scratch.
- ▶ Do not use caustic or abrasive cleaning materials or those containing sand, chloride, or acids.

- ▶ Plastic surfaces: clean by hand with a soft clean cloth, lukewarm water and a little detergent.
- ▶ Metal surfaces: clean by hand with a soft clean cloth, lukewarm water and a little detergent.
- ▶ Drain hole: remove any deposits with a thin item such as a cotton bud.

9.4.3 Cleaning the equipment

NOTICE

Improper cleaning!
Damage to the appliance.

- ▶ Only use soft cleaning cloths and ph-neutral all-purpose cleaners.
- ▶ Do not use steel wool or sponges that scour or scratch.
- ▶ Do not use caustic or abrasive cleaning materials or those containing sand, chloride, or acids.

Clean with a soft, clean cloth, lukewarm water and a little washing up liquid:

- Door racks
- Shelf
- EasyFresh-Safe
- Drawer
Please note: Do not remove the magnet on the drawer. The magnet ensures that the IceMaker functions.*
- Divider in the IceMaker drawer*

Clean with a damp cloth:

- Retracting rails
Please note: the grease in the tracks is there for lubrication purposes and must not be removed!

Clean in the dishwasher up to 60 °C (140 °F):

- Bottle rack
- Ice cube scoop*

- ▶ Disassemble the equipment: see the relevant section.
- ▶ Clean the equipment.

9.4.4 Cleaning the IceMaker*

There are various options for cleaning the IceMaker.

We recommend cleaning in the following situations:

- Initial commissioning
- With water connection:*
If out of use for longer than 5 days.*

Make sure that the following requirements are met:

- IceMaker drawer is emptied.
- IceMaker drawer is fully inserted.
- The IceMaker has been activated.

On first use or if not used for prolonged periods

Clean the IceMaker with TubeClean.

- ▶ Put an empty 1.5 l (1.59 qt) vessel (max. height 10 cm (3 15/16 in)) in the drawer under the IceMaker.
- ▶ Activate the TubeClean function.
- ▷ The rinse process is prepared (max. 60 min.): The symbol flashes.
- ▷ Water pipes are rinsed: Symbol flashes.
- ▷ Rinsing process is complete: Function turns off automatically.
- ▶ Take out the IceMaker drawer and remove the container.
- ▶ Clean the IceMaker drawer with warm water and a little detergent.
- ▶ Push in the IceMaker drawer.
- ▷ Ice cube production starts automatically.
- ▶ Dispose of any ice cubes that are produced within 24 hours of the first ice cube production.

When cleaning is required

Clean the IceMaker manually.

- ▶ Remove the IceMaker drawer and clean with warm water and a little detergent.
- ▶ Push in the IceMaker drawer.
- ▷ Ice cube production starts automatically.

9.4.5 After cleaning

- ▶ Wipe dry the appliance and items of equipment
- ▶ Connect and switch on the appliance.
- ▶ Activate SuperFrost (see 7.2 Appliance functions).
When the temperature is sufficiently cold
- ▶ Place the food inside.
- ▶ Repeat cleaning regularly.

10 Customer support

10.1 Technical specifications

Temperature zone	
Cool:	2 °C (34 °F) to 9 °C (46 °F)
Freezing	-26 °C (-15 °F) to -15 °C (5 °F)

Customer support

Maximum freezing quantity/24 h	
Freezer	See "Freezing capacity .../24 h" on the type plate

Max. door capacity		
Number of drawers, freezer	Top door	Bottom door
3 drawers	12 kg (26.46 lb)	--

Max. equipment capacity			
Equipment	Appliance width 550 mm (21 5/8 in) (see installation instructions, appliance dimensions)	Appliance width 600 mm (23 1/2 in) (see installation instructions, appliance dimensions)	Appliance width 700 mm (27 9/16 in) (see installation instructions, appliance dimensions)
Drawer on glass shelf (see 8.4.1 Drawer on appliance base or glass shelf)	12 kg (26.46 lb)	15 kg (33.07 lb)	--

Max. size baking tray	
Width	466 mm (18 3/8 in)
Depth	386 mm (15 3/16 in)
Height	50 mm (1 15/16 in)

Ice cube production with IceMaker*	
Ice cube production/24 h	At a temperature of -18 °C (-0 °F): 1.2 kg (2.65 lb) of ice cubes
Maximum ice cube production/24 h	When the MaxIce function is active: 1.5 kg (3.31 lb) of ice cubes

10.2 Operating noises

The appliance makes noises while in operation.

- At **less cooling output** the appliance saves energy but takes longer to cool items. The volume is **lower**.
- At a **higher cooling output** the food cools more quickly. The volume is **higher**.

Examples:

- Activated functions (see 7.2 Appliance functions)
- Running fan
- Freshly sorted food
- High ambient temperature
- Door opened for long periods

Noise	Possible cause	Type of noise
Bubbling and splashing	Coolant is flowing into the cooling circuit.	Normal noise
Spitting and hissing	Coolant is spraying into the cooling circuit.	Normal noise
Humming	The appliance cools. The volume depends on the cooling output.	Normal noise
Whirring and murmuring	The fan is running.	Normal operating noise
Clicking	Components are being switched on and off.	Normal switching noise
Rattling or humming	Valves are active.	Normal switching noise

Noise	Possible cause	Type of noise	How to resolve
Vibration	Unsuitable installation	Error noise	Check installation. Set up the appliance.
Clattering	Equipment, Objects inside the appliance	Error noise	Secure equipment parts. Leave a gap between items.

10.3 Technical faults

Your appliance is designed and manufactured for reliable operation and a long service life. If a malfunction nonetheless occurs during operation, please check whether the malfunction is due to an operating error. In this case, you will have to be charged for the costs incurred, even during the warranty period.

You may be able to rectify the following faults yourself.

10.3.1 Appliance function

Defect	Cause	Remedy
The appliance does not work.	The appliance is not switched on.	▶ Switch on the appliance.
	The power plug is not properly inserted in the wall socket.	▶ Check the power plug.
	The powerfuse in the wall socket is not OK.	▶ Check the fuse.
	Power failure.	▶ Keep the appliance closed. ▶ Protect your food: Lay freezer packs on top of the food or use another freezer if the power is off for a prolonged period. ▶ Do not re-freeze defrosted food.
	The appliance connector is not correctly inserted in the appliance.	▶ Check the appliance connector.
The temperature is not cold enough	This means that the door of the appliance is not closed properly	▶ Close the appliance door
	Insufficient ventilation	▶ Clear and clean the ventilation grille.
	The ambient temperature is too high	▶ Problem solution: (see 1.4 Range of appliance use)
	The appliance was opened too frequently or for too long	▶ Wait to see if the required temperature corrects itself. If not, contact Customer Service. (see 10.4 Customer Service)
	Too much fresh food was placed inside without SuperFrost.	▶ Solution: (see SuperFrost)
	The temperature is incorrectly set	▶ Set to a colder temperature and check after 24 hours.
	The appliance is too near to a heat source (stove, heater etc).	▶ Change location of appliance or the heat source.
	The appliance was not properly installed in the recess.	▶ Make sure the appliance was installed correctly and the door closes properly.
The door seal is defective or should be replaced for other reasons.	The door seal is interchangeable. You can replace it without the use of any special tools.	▶ Contact Customer Service. (see 10.4 Customer Service)
The appliance is iced up or condensation is building.	The door seal may have slipped out of its groove.	▶ Check the door seal is well placed in the groove.

10.3.2 Equipment

Defect	Cause	Remedy
	The appliance and therefore the IceMaker are not connected.	▶ Connect the appliance (see Installation Guide).

Decommissioning

Defect	Cause	Remedy
The IceMaker cannot be switched on.*		
The IceMaker is not making any ice cubes.*	The IceMaker is not switched on.	▶ Activate the IceMaker.
	The drawer of the IceMaker is not properly closed	▶ Close the drawer properly
	The water connection is not open	▶ Open the water connection*
The interior light does not turn on.	The appliance is not switched on.	▶ Switch on the appliance.
	The door was open for longer than 15 min.	▶ The interior light automatically switches itself off if the door stays open for approx. 15 min.
	The LED interior light is faulty or the lid is damaged.	▶ Contact Customer Service. (see 10.4 Customer Service)

10.4 Customer Service

First check whether you can rectify the fault yourself (see 10 Customer support) . If you cannot rectify the problem, contact Customer Service.

You can find the address in the enclosed brochure “Liebherr-Service” or at home.liebherr.com/service.



WARNING

Unprofessional repair!
Injuries.

- ▶ A damaged power cable may only be replaced by the manufacturer, the manufacturer’s Customer Service or a similarly qualified person.
- ▶ For appliances with plug and play connection cables, the change can be made by the customer.

10.4.1 Contacting Customer Service

Make sure that the following appliance information is available:

- Appliance name (model and index)
 - Service no. (service)
 - Serial no. (S no.)
 - ▶ Call up the appliance information via the display. (see Appliance information)
- or-**
- ▶ Refer to the type plate for appliance information. (see 10.5 Rating plate)
 - ▶ Take note of the appliance information.
 - ▶ Notify customer service: Report errors and the appliance information.
 - ▷ This will help us give you fast and accurate support.
 - ▶ Follow further instructions from Customer Service.

10.5 Rating plate

The nameplate is located behind the drawers on the inside of the appliance.

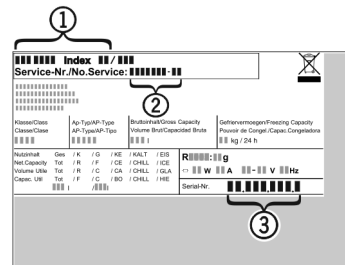

Fig. 131

- (1) Appliance name
 - (2) Service no.
 - (3) Serial no.
- ▶ Information from the nameplate.

11 Decommissioning

- ▶ Empty appliance.
- ▶ Deactivate IceMaker. (see Deactivating IceMaker) *
- ▶ Switch off appliance. (see Switching appliance off and on)
- ▶ Pull the power plug from the outlet.
- ▶ If necessary, remove the IEC socket: Pull the IEC socket out of the appliance plug while turning it to the left and right at the same time.
- ▶ Clean appliance. (see 9.4 Cleaning the appliance)
- ▶ Leave the door open to prevent unpleasant odors.

12 Disposal

12.1 Preparing the appliance for disposal



WARNING

Risk of child entrapment!

Before you throw away your old refrigerator or freezer:

- ▶ Take off the doors.
- ▶ Leave the shelves in place so that children may not easily climb inside.



Li-Ion

Liebherr uses batteries in some of its appliances. You should remove these before disposal of the old appliance for environmental reasons. If your appliance contains batteries, a corresponding notice is attached to the appliance.

Lamps If you can remove the lamps yourself without destroying them, also remove these before disposal.

- ▶ Take the appliance out of operation.
- ▶ Appliance with batteries: Remove the batteries. For description, see **Maintenance** chapter.
- ▶ If possible: Remove lamps without destroying them.

12.2 Disposing of the appliance in an environmentally friendly manner



The appliance still contains valuable materials and must be collected separately from unsorted municipal waste so it can be recycled.



Li-Ion



Li-Ion

Dispose of batteries separately from the old appliance. Certain batteries should NOT go in household garbage or recycling bins. Waste batteries can always be recycled or taken to household hazardous waste collection points. To prevent fires from lithium-ion batteries, tape battery terminals and/or place batteries in separate plastic bags and never put these batteries in household garbage or recycling bins.

Lamps Dispose of removed lamps via the respective collection systems.

For USA:

Check the Responsible Appliance Disposal (RAD) program to find a RAD partner near you.

For Canada:

Follow your local guidance about recycling and disposal capabilities near you.



WARNING

Leaking refrigerant and oil!

Fire. The refrigerant contained within the appliance is environmentally friendly, but flammable. The oil contained within the appliance is flammable. Escaping refrigerant and oil can ignite if they are of high enough concentration and are exposed to an external heat source.

- ▶ Do not damage the pipelines of the coolant circuit and the compressor.
- ▶ Observe the notes on appliance transport.
- ▶ Transport the appliance away without damaging it.
- ▶ Dispose of batteries, lamps, and the appliance according to the above specifications.



home.liebherr.com/fridge-manuals

EN Built-in combined fridge-freezer

Issue date: 20240618

Part number index: 7088431-00

For Service in the U.S.: Liebherr Service Center
Toll Free: 1-866-LIEBHER or 1-866-543-2437
Service-appliances.us@liebherr.com
PlusOne Solutions, Inc.
3501 Quadrangle Blvd, Suite 120
Orlando, FL 32817

For Service in Canada: Liebherr Service Center
Toll Free: 1-888-LIEBHER or 1-888-543-2437
www.euro-parts.ca
EURO-PARTS CANADA
39822 Belgrave Road, Belgrave, Ontario, N0G 1E0
Phone: (519) 357-3320 | Fax: (519) 357-1326