

Technische Daten Raupenkran

LR 1200
Litronic®



LIEBHERR

Abmessungen

Grundgerät mit Unterwagen

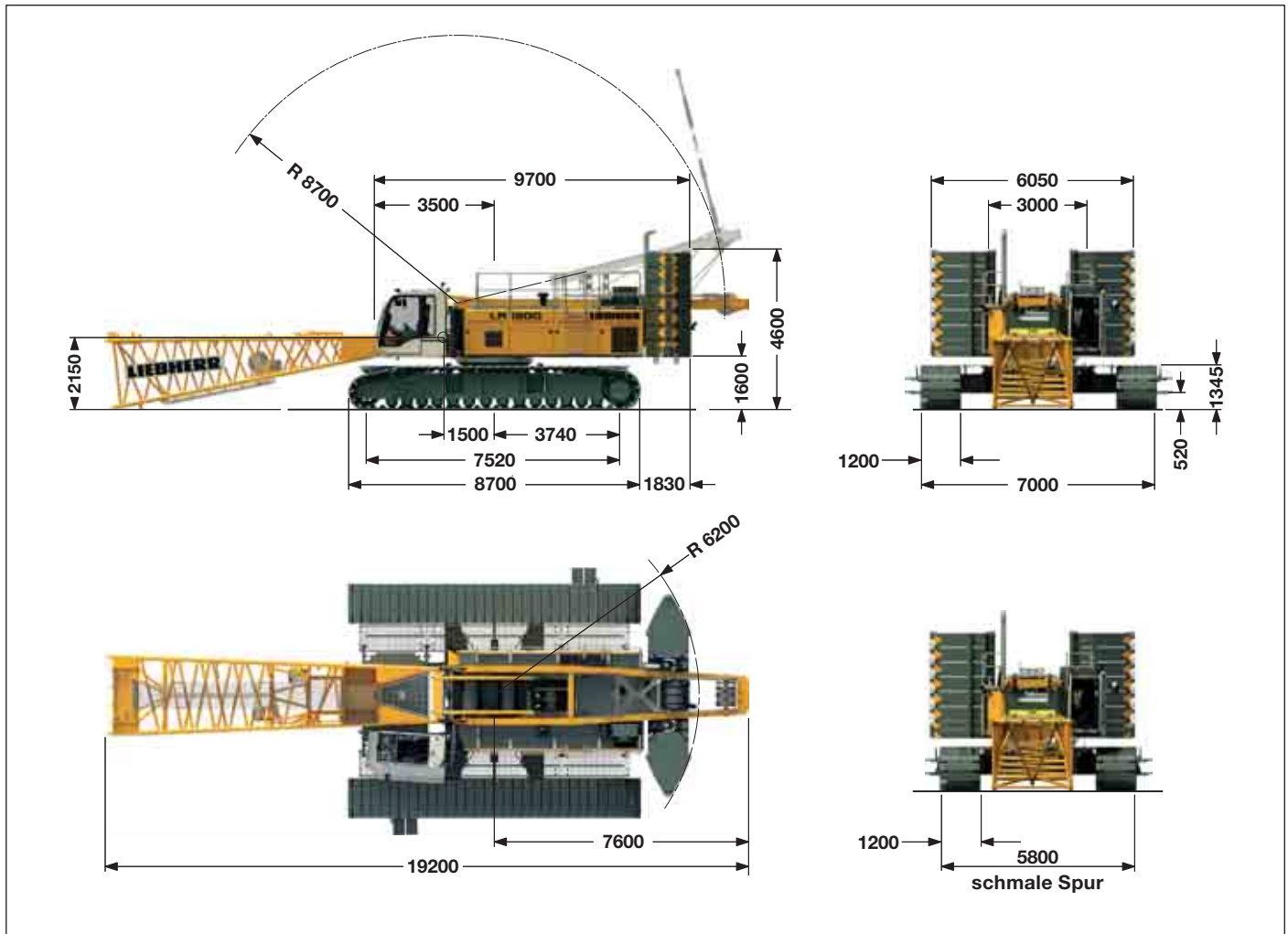

Dienstgewichte

Die Dienstgewichte beinhalten das Grundgerät mit Plattenlaufwerk, 2 Hauptwinden 120 kN inklusive Beseilung (260 m und 495 m) und 20 m Hauptausleger bestehend aus Aufrichtmast, Auslegeranlenkstück (10 m), Auslegerkopf (7 m) und Auslegerzwischenstück (3 m), 82,3 t Grundballast, 36 t Zentralballast und 250 t Hakenflasche.

Gesamtgewicht _____ ca. 210 t

Bodenbelastung

Bodenbelastung _____ 1.16 kg/cm²

Ausrüstung

Hauptausleger (No. 2320.xx) max. Länge _____ 89 m
 Leichtausleger (No. 2320.xx und 1916.xx) _____ 117 m
 Verstellbarer Nadelausleger (No. 1916.xx) max. Länge _____ 95 m
 Max. Auslegerkombination _____ Hauptausleger 53 m
 Verstellbarer Nadelausleger 95 m
 Feststehender Nadelausleger (No. 1008.xx) _____ 11 m – 26 m
 Spitzenausleger 24 t (optional 36 t)

Anmerkungen

1. Traglasten für Einsatz als Montagekran (entspricht Kraneinstufung nach F.E.M. 1.001. Krangruppe A1).
2. Die Maschine steht auf tragfähigem, waagrechtem Untergrund.
3. Das Gewicht des Lastaufnahmemittels (Hakenflasche, Hubseile, Schäkel usw.) ist von der Traglast abzuziehen.
4. Zusatzlasten am Ausleger (wie z.B. Podeste) sind von den Traglasten abzuziehen.
5. Die maximal zulässige Windgeschwindigkeit entnehmen Sie bitte dem Traglasttabellenbuch.
6. Die Ausladungen sind von Mitte Drehkranz und unter Last angegeben.
7. Die Traglasten sind in Tonnen angegeben und 360° schwenkbar.
8. Desweiteren sind für die Berechnung der Standsicherheit die DIN 15019 / Teil 2 / Tab. 1 und ISO 4305 Tab. 1 + 2, als auch die Kippwinkelmethode 4° zugrunde gelegt.
9. Für die Stahltragwerke gilt F.E.M. 1.001 - 1998 (EN 13001-1; EN 13001-2).

Transportmaße und Gewichte

Grundgerät und Hauptausleger (No. 2320.xx)

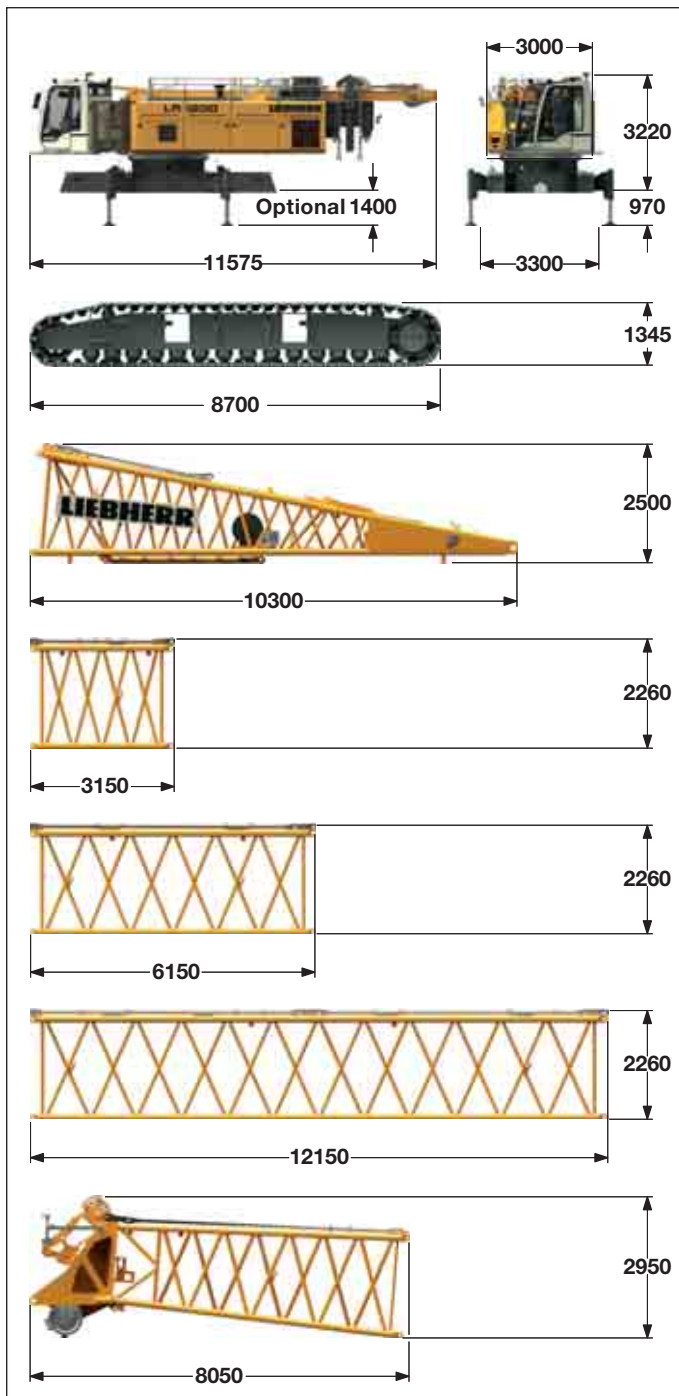

1) Haltestangen Hauptausleger • 2) Haltestangen Nadelausleger

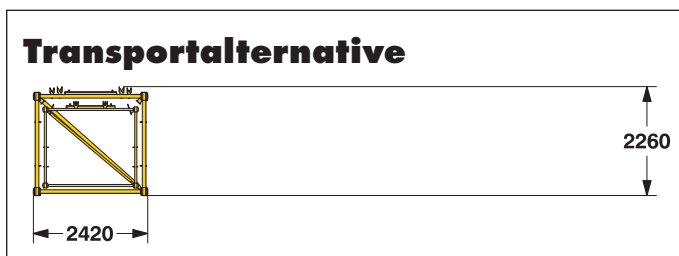

*) Inklusive Haltestangen

Grundgerät

mit Aufrichtmast, 2x 120 kN Kranwinden ohne Anlenkstück, Hubseile, Grundballast und Laufwerke

Breite	3000 mm
Gewicht	42500 kg
Gewicht Hubseil	3.42 kg/m

Laufwerke

2 x

Flachbodenplatten	1200 mm
Breite	1200 mm
Gewicht	19800 kg

Anlenkstück (No. 2320.25)

Breite	2430 mm
Gewicht mit Winde inkl. Seil	5600 kg
Gewicht ohne Winde	4000 kg

Zwischenstück (No. 2320.23)

3 m

Breite	2430 mm
Gewicht mit HPT ¹⁾	830 kg
Gewicht mit HPT ¹⁾ und NDL ²⁾	920 kg

Zwischenstück (No. 2320.20)

6 m

Breite	2430 mm
Gewicht mit HPT ¹⁾	1125 kg
Gewicht mit HPT ¹⁾ und NDL ²⁾	1285 kg

Zwischenstück (No. 2320.20)

12 m

Breite	2430 mm
Gewicht mit HPT ¹⁾	2030 kg
Gewicht mit HPT ¹⁾ und NDL ²⁾	2380 kg

Auslegerkopf (No. 2320.23)

Breite	2430 mm
Gewicht mit HPT ¹⁾	4300 kg

Hauptausleger-Transportalternative

(No. 2320.xx/1916.xx)	12/12	6/6	3/3	m
Länge	12250	6250	3250	mm
Gewicht*	3610	1975	1475	kg

Transportmaße und Gewichte

Verstellbarer Nadelausleger (No. 1916.xx)

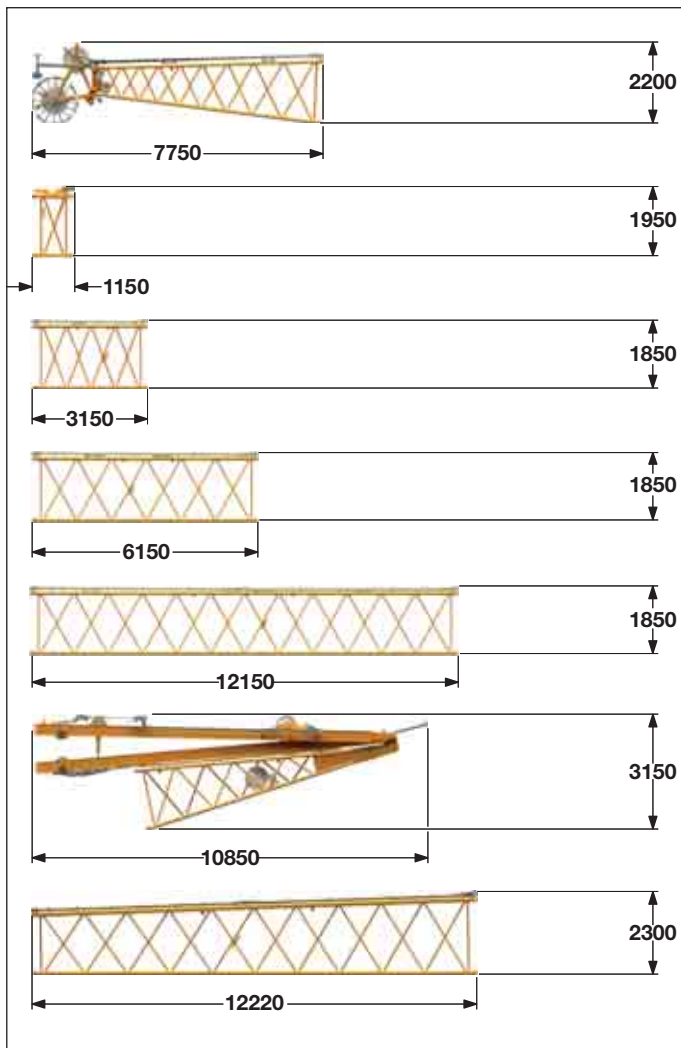

Nadelkopf (No. 1916.21)

Breite	2010 mm
Gewicht*	1550 kg

Leichtausleger-Z-Stück (No. 1916.22) 1 m

Breite	2010 mm
Gewicht*	460 kg

Zwischenstück (No. 1916.18) 3 m

Breite	2010 mm
Gewicht*	475 kg

Zwischenstück (No. 1916.18) 6 m

Breite	2010 mm
Gewicht*	690 kg

Zwischenstück (No. 1916.18) 12 m

Breite	2010 mm
Gewicht*	1250 kg

Anlenkstück mit A-Böcken (No. 1916.22)

Breite	2010 mm
Gewicht*	6300 kg

Leichtausleger-Reduzierstück (No. 2320/1916.20) 12 m

Breite	2430 mm
Gewicht*	1700 kg

Feststehender Nadelausleger (No. 1008.xx)

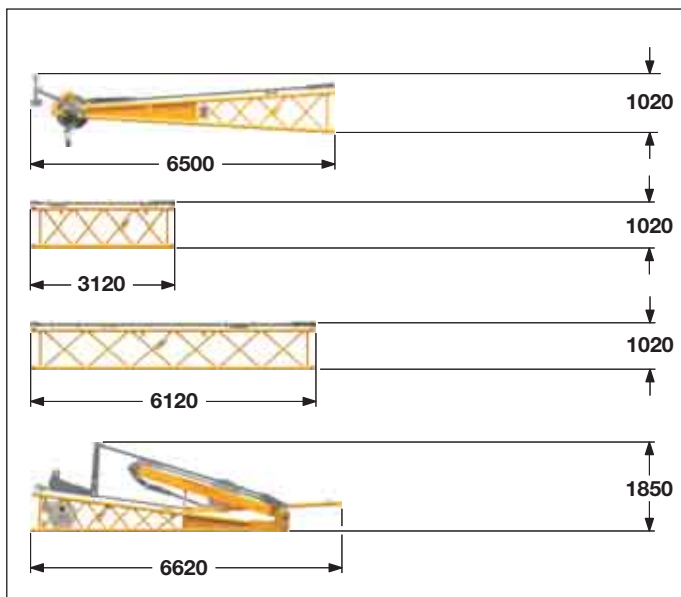

Nadelkopf (No. 1008.20)

Breite	1090 mm
Gewicht*	920 kg

Zwischenstück (No. 1008.17) 3 m

Breite	1090 mm
Gewicht*	300 kg

Zwischenstück (No. 1008.17) 6 m

Breite	1090 mm
Gewicht*	455 kg

Anlenkstück mit A-Bock (No. 1008.20)

Breite	2200 mm
Gewicht*	1950 kg

*) Inklusive Haltestangen

Transportmaße und Gewichte

Ballast

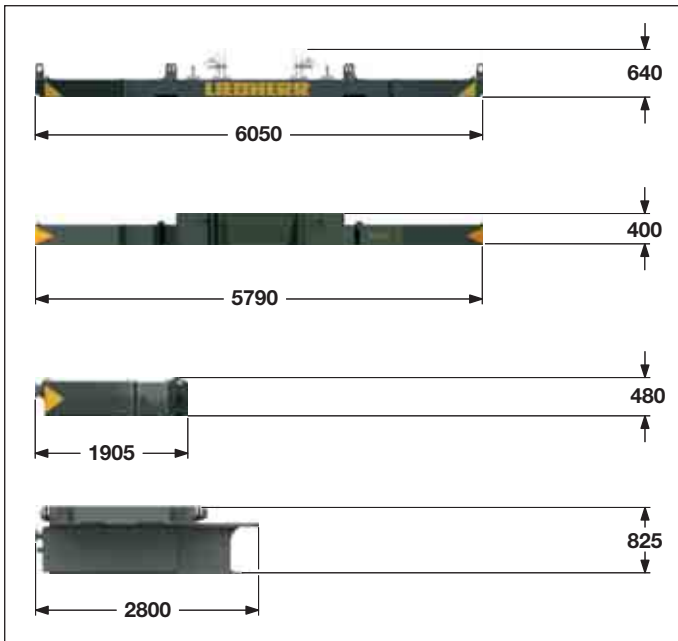

Ballastplatte **1 x**

Breite	1660 mm
Gewicht	12000 kg

Ballastplatte **1 x**

Breite	1660 mm
Gewicht	10000 kg

Ballastplatte **12 x**

Breite	1360 mm
Gewicht	5000 kg

Zentralballastplatte **2 x**

Breite	3340 mm
Gewicht	9800 kg

Zentralballastplatte **2 x**

Breite	3340 mm
Gewicht	8300 kg

Mid fall (optional)

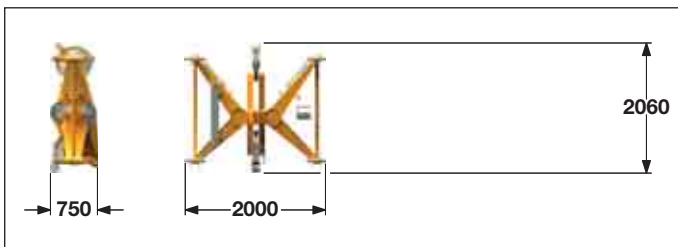

Mid fall Zwischenstück (No. 1916.xx) **0.5 m**

Breite	750 mm
Gewicht	715 kg

Haken

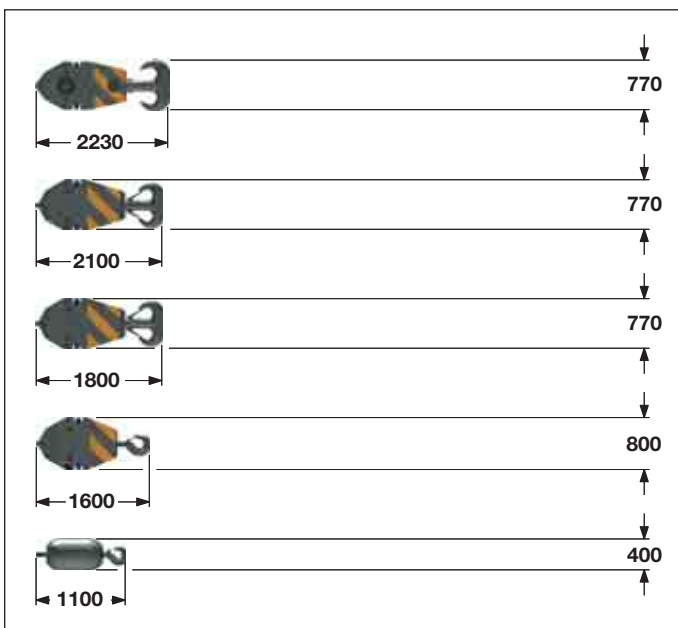

250 t Hakenflasche - 11 Rollen

Breite	1030	1250 mm
Gewicht	2300	3200 kg

160 t Hakenflasche - 7 Rollen

Breite	640	760	880 mm
Gewicht	1500	2250	3000 kg

100 t Hakenflasche - 5 Rollen

Breite	540	670	770 mm
Gewicht	1300	1800	2300 kg

40 t Hakenflasche - 1 Rolle

Breite	300	400	500 mm
Gewicht	700	1100	1500 kg

12.5 t Einzelhaken

Breite	400 mm
Gewicht	600 kg

Technische Beschreibung



Motor

Leistung nach ISO 9249, 270 kW (367 PS) bei 2000 U/min
Modell _____ Liebherr D 936 A7 SCR
Kraftstofftank _____ 800 l Tankinhalt mit kontinuierlicher
Niveauanzeige und Reserveangabe

Der Dieselmotor entspricht der Abgaszertifizierung für mobile Maschinen nach EPA / CARB Tier 4i oder 97/68 EG Stufe III B.



Windwerke

Seilzug in der 1. Lage _____ max. 175 kN
Seilzug in der 7. Lage _____ 120 kN
Seildurchmesser _____ 26 mm
Seiltrommeldurchmesser _____ 580 mm
Seilgeschwindigkeit _____ 0 – 136 m/min
Seilkapazität in 7 Lagen _____ 489 m

Die Winden zeichnen sich durch ihre kompakte, montagefreundliche Bauweise aus.

In Öl laufende, innenliegende, wartungsarme Planetengetriebe. Lastabstützung über Hydraulikanlage, zusätzliche Sicherheit durch federbelastete Lamellenbremse (Stillstandsbremse).

Für die Hauptwinden werden hochdruckgeregelte Verstellölmotoren verwendet. Diese erlauben schon im Teillastbereich die volle Ausnutzung der installierten Motorleistung durch Geschwindigkeitsanpassung an den jeweiligen Seilzug.

Auf Wunsch – Winde mit Freifalleinrichtung:

Bei der Freifalleinrichtung wird sowohl die Kupplungs- als auch die Bremsfunktion über die Arbeitsbremse realisiert. Diese Bremse ist eine verschleißarme, wartungsfreie Lamellenbremse in kompakter Bauweise.



Hydraulikanlage

Eine doppelte Verstellpumpe versorgt die Hydraulikanlage im offenen Kreislauf und ermöglicht das gleichzeitige Fahren aller Bewegungen. Um hydraulische Druckspitzen abzufangen wurde eine automatisch arbeitende Druckabschneidung integriert.

Alle Filter werden elektronisch überwacht.

Die Verwendung synthetischer, umweltfreundlicher Öle ist möglich.

Arbeitsdruck max. — 350 bar

Hydrauliktankinhalt — 650 l



Fahrwerk

Fahrwerksantrieb mit Axialkolbenmotor, hydraulisch löfzbare, federbelastete Lamellenbremse, Laufwerk mit hydraulischer Kettenspannung.

Flachbodenplatten — 1200 mm

Fahrgeschwindigkeit — 0 – 1.6 km/h



Nadelausleger-Verstellwinde

Seilzug _____ max. 105 kN

Seildurchmesser _____ 20 mm

Verstellung Nadelausleger von 15° bis 78° in 51 sec.



Steuerung

Die von Liebherr entwickelte und im eigenen Haus gefertigte Steuerung ist das Herzstück der Raupenkrane.

Sie umfasst alle Steuer- und Kontrollfunktionen und ist für extreme Temperaturbereiche sowie für den harten Baustelleneinsatz konzipiert. Alle Betriebsdaten des Gerätes sowie Warnungen oder eventuelle Störmeldungen werden auf einem kontraststarken Bildschirm in der Fahrerkabine in der jeweiligen Landessprache angezeigt.

Mit der elektrohydraulischen Proportionalsteuerung können mehrere Bewegungen gleichzeitig und sehr feinfühlig gefahren werden, was in allen Lastbereichen eine ausgezeichnete Positionierbarkeit gewährleistet.

Option:

- GSM/GPRS-Telematikmodul



Hauptausleger-Verstellwinde

Seilzug _____ max. 217 kN

Seildurchmesser _____ 24 mm

Verstellung Hauptausleger von 15° bis 86° in 130 sec.



Schwenkwerk

Rollendrehkranz mit außenliegender Verzahnung, Schwenkwerk mit Axialkolbenmotor, hydraulisch löfzbare Lamellenbremse, Planetengetriebe und Drehwerksritzel.

Das Schwenkwerk kann sowohl mit Geschwindigkeitsvorwahl wie auch im Freilauf betrieben werden.

Bei der Geschwindigkeitsvorwahl schließt eine Lamellenbremse (Stillstandsbremse), wenn keine Drehbewegung vorhanden ist.

Drehwerksgeschwindigkeit 0 – 3 U/min stufenlos regelbar.



Schallemission

Die Schallemissionen entsprechen der Richtlinie 2000/14/EG über Geräuschemissionen von zur Verwendung im Freien vorgesehenen Geräten und Maschinen.

Auslegerkombinationen

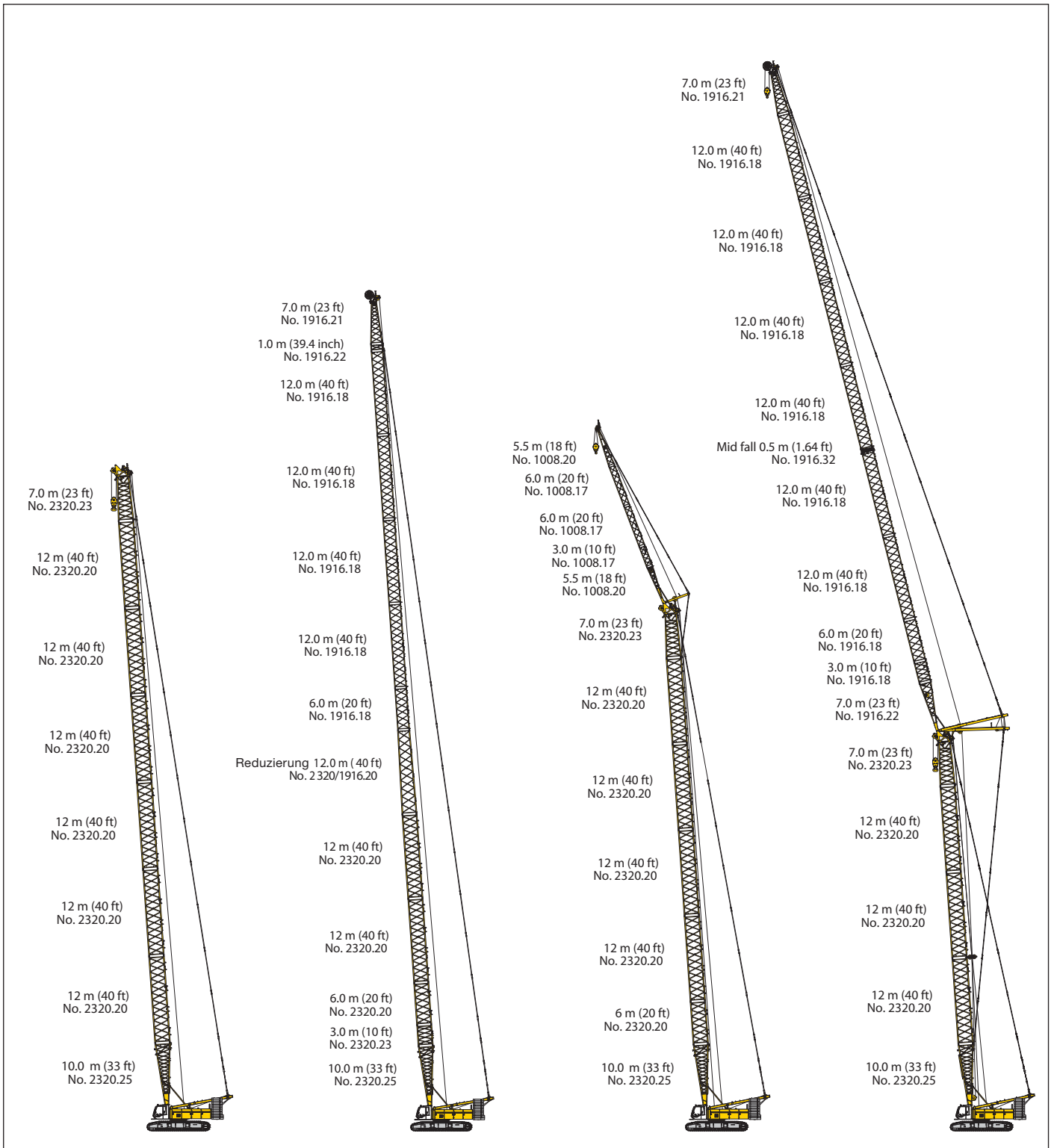

Hauptausleger No. 2320.xx · 89 m

Max. Kombination — 117 m

Max. Kombination — 97.0 m

Max. Kombination — 148 m

Hauptausleger No. 2320.xx · 43 m

Reduzierung No. 2320/1916.xx — 12 m

Verstellbarer Nadelausleger No. 1916.xx — 62 m

Hauptausleger No. 2320.xx · 71 m

Feststehender Nadelausleger No. 1008.xx — 26 m

Hauptausleger No. 2320.xx · 53 m

Verstellbarer Nadelausleger No. 1916.xx — 95 m

Hauptausleger No. 2320.xx · 56 m

Verstellbarer Nadelausleger No. 1916.xx — 80 m

Selbstmontage-System

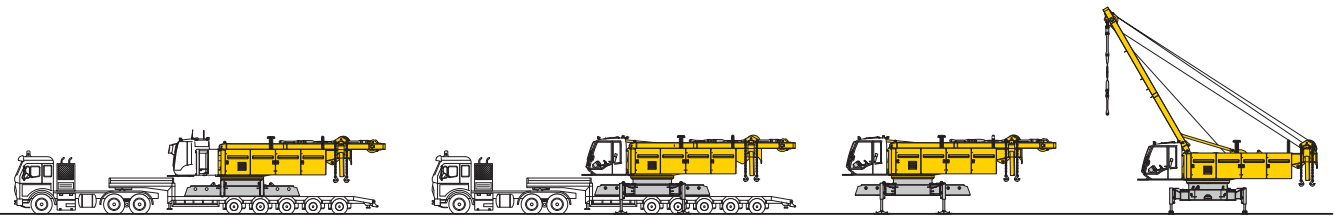

Entladung des Grundgerätes

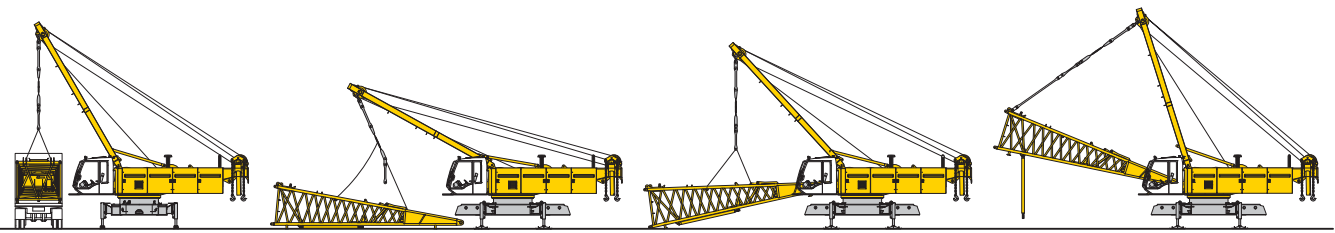

Entladung und Anbau des Anlenkstücks

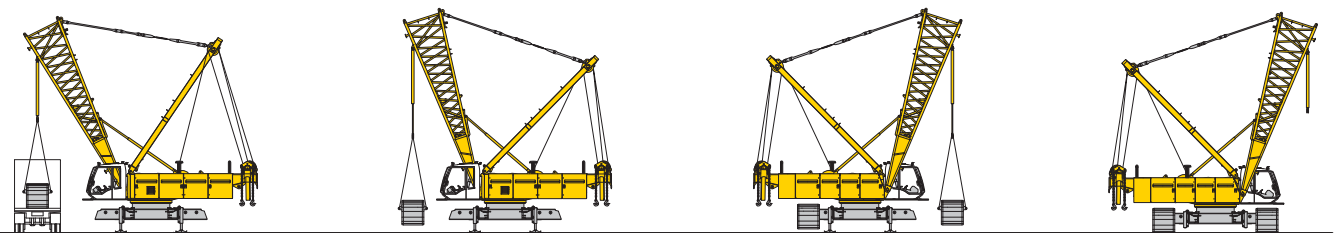

Entladung und Anbau der Laufwerke

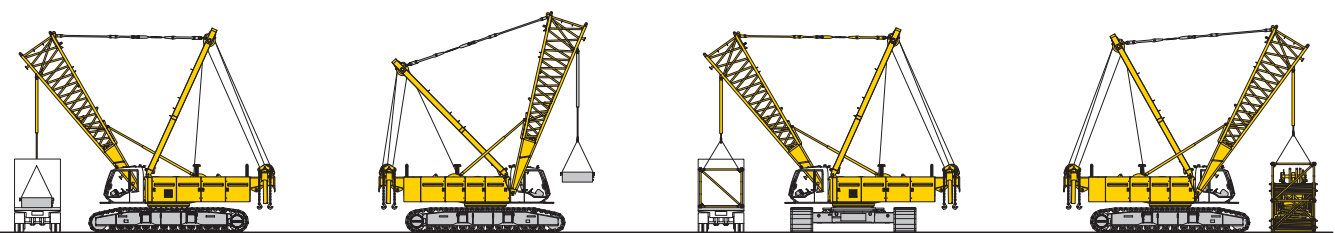

Entladung und Anbau des Zentralballastes

Entladung und Zusammenbau des Auslegers



Entladung, Zusammen- und Anbau des Gegengewichtes

Ausleger aufrichten - Kran in Arbeitsposition

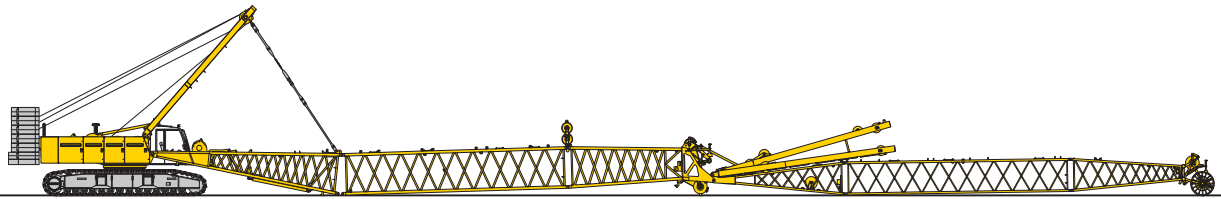

Anbau des Auslegers

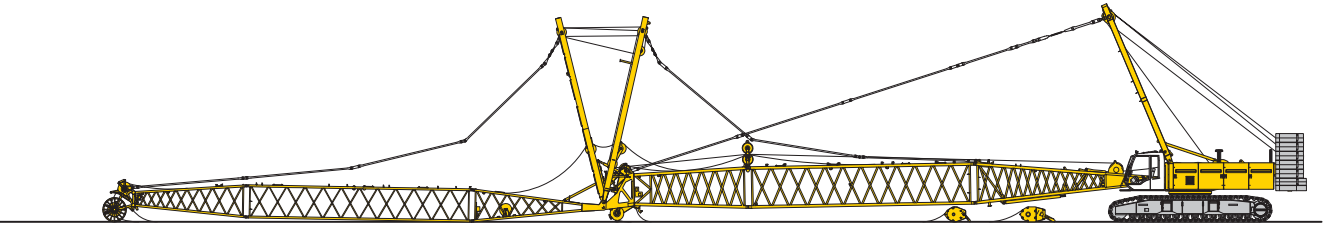

Einziehen der Hub- und Nadelseile



Haupt- und Nadelausleger anheben

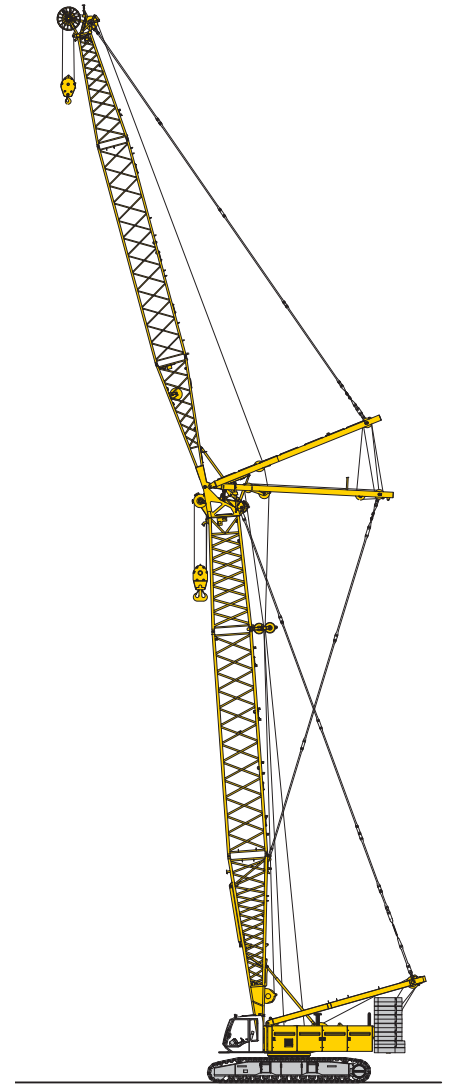

Kran in Arbeitsposition

Hauptausleger (No. 2320.xx) 86° - 15°

82.3 t Ballast und 36 t Zentralballast

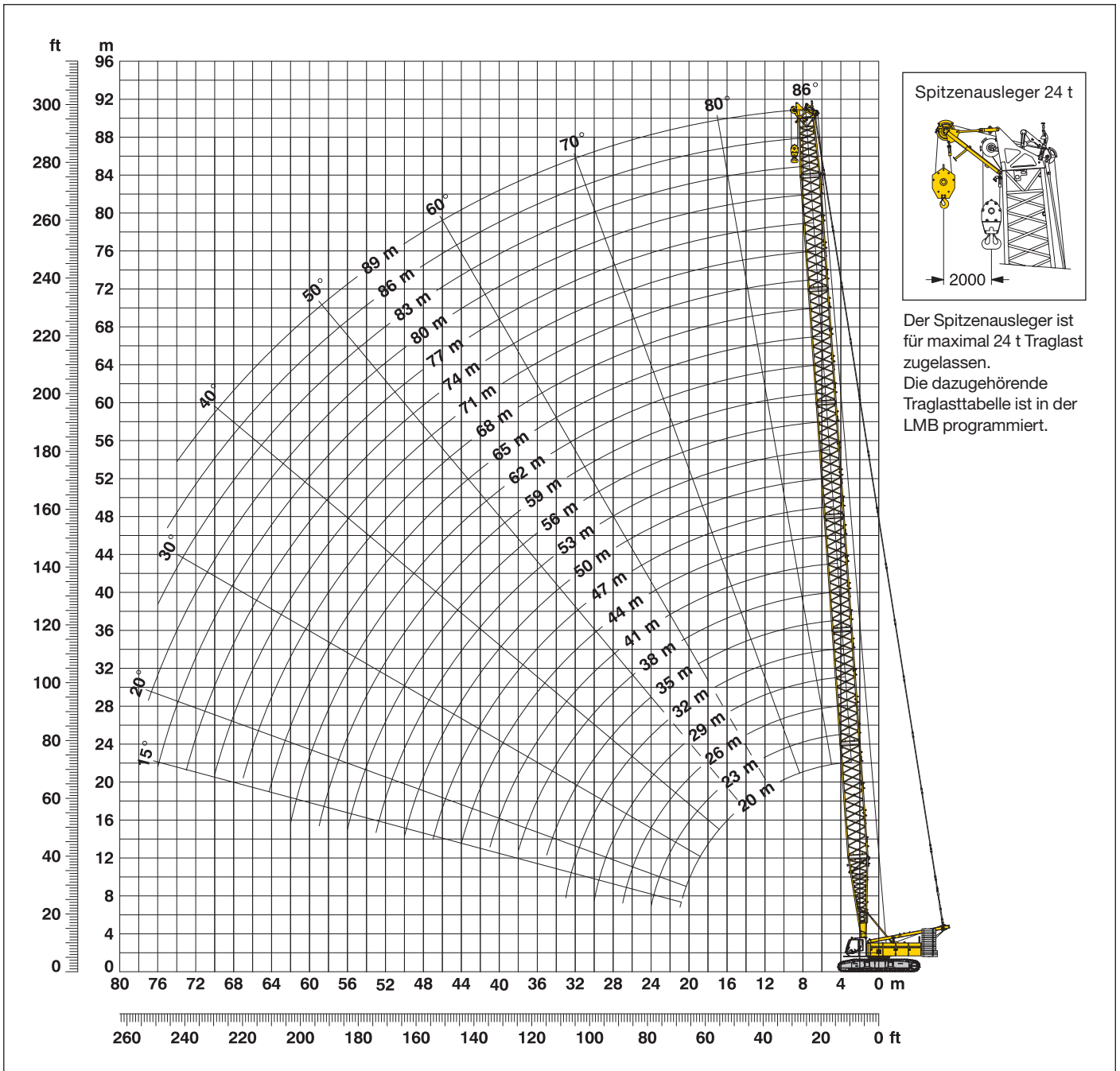

Hauptausleger-Zusammenbau (Tabelle 1 - No. 2320.xx)

Hauptausleger für Auslegerlängen von 20 m bis 89 m

Anlenkstück	Länge	Anzahl der Hauptauslegerstücke																							
		20	23	26	29	32	35	38	41	44	47	50	53	56	59	62	65	68	71	74	77	80	83	86	89
Anlenkstück	10 m	1	1	1	1	1	1	1	1	1	1	1	1	1	1	1	1	1	1	1	1	1	1	1	1
Z-Stück	3 m	1		1		1		1		1		1		1		1		1		1		1		1	
Z-Stück	6 m		1	1		1	1		1	1		1	1		1	1		1	1		1	1		1	1
Z-Stück	12 m				1	1	1	1	2	2	2	2	3	3	3	3	4	4	4	4	5	5	5	5	6
Kopfstück	7 m	1	1	1	1	1	1	1	1	1	1	1	1	1	1	1	1	1	1	1	1	1	1	1	1
Auslegerlänge (m)		20	23	26	29	32	35	38	41	44	47	50	53	56	59	62	65	68	71	74	77	80	83	86	89

Traglasten - Hauptausleger (No. 2320.xx)

82.3 t Ballast und 36 t Zentralballast

Traglasten in Tonnen (t) für Auslegerlängen von 20 m bis 89 m – mit 120 kN Winden

Radius (m)	Auslegerlänge (m)												Radius (m)	
	20	26	32	38	44	50	56	62	68	74	80	86		89
6	t	t	t	t	114.8	t	t	t	t	t	t	t	t	6
7				129.5	107.8	90.1	80.3	65.4						7
8		140.8	132.2	118.8	100.9	83.7	77.6	64.9	52.1	45.0				8
9	128.6	122.5	115.7	109.5	93.2	78.8	74.8	62.1	50.3	44.7	37.0	30.2	26.6	9
10	113.8	108.2	102.8	97.7	87.2	73.6	71.9	60.2	48.3	43.1	36.0	30.0	26.6	10
12	87.2	87.2	83.7	80.0	76.7	66.3	66.8	55.6	44.6	40.7	34.0	28.2	25.2	12
14	70.2	70.3	70.3	67.5	65.0	59.2	60.2	52.3	41.4	38.1	31.7	26.6	24.0	14
16	58.5	58.5	58.5	58.2	56.1	53.7	52.2	48.5	38.8	36.2	29.9	25.0	22.5	16
18	49.9	49.9	49.9	49.7	49.2	47.5	45.9	44.3	36.0	34.3	28.5	23.7	21.3	18
20	43.2	43.3	43.3	43.1	42.9	42.2	40.8	39.4	33.7	32.6	27.0	22.6	20.4	20
26		30.3	30.4	30.2	30.0	29.6	29.4	29.0	28.0	27.0	23.5	19.9	17.7	26
32			22.7	22.6	22.4	22.0	21.8	21.4	21.1	20.6	19.8	17.6	16.1	32
38				17.5	17.3	17.0	16.8	16.4	16.1	15.7	15.3	14.5	14.1	38
44					13.7	13.5	13.2	12.8	12.5	12.1	11.8	11.3	11.0	44
50						10.8	10.6	10.2	9.9	9.5	9.2	8.8	8.6	50
55							8.8	8.5	8.2	7.8	7.4	7.0	6.9	55
60								7.0	6.7	6.3	6.0	5.6	5.4	60
65									5.4	5.1	4.7	4.3	4.2	65
70										4.0	3.7	3.3	3.2	70
75											2.8	2.4	2.3	75

TLT 10576478 - M00000

Traglasten - Hauptausleger (No. 2320.xx)

72.3 t Ballast und 36 t Zentralballast

Traglasten in Tonnen (t) für Auslegerlängen von 20 m bis 89 m – mit 120 kN Winden

Radius (m)	Auslegerlänge (m)												Radius (m)	
	20	26	32	38	44	50	56	62	68	74	80	86		89
4.1	220.0	t	t	t	t	t	t	t	t	t	t	t	t	4.1
5	217.0	162.8	153.6											5
6	185.8	159.0	150.7	140.3	114.8									6
7	162.1	152.1	141.4	129.5	107.8	90.1	80.3	65.4						7
8	138.5	129.4	121.4	114.2	100.9	83.7	77.6	64.9	52.1	45.0				8
9	119.4	112.4	106.2	100.5	93.2	78.8	74.8	62.1	50.3	44.7	37.0	30.2	26.6	9
10	104.4	99.2	94.2	89.5	85.3	73.6	71.9	60.2	48.3	43.1	36.0	30.0	26.6	10
12	79.9	79.9	76.7	73.3	70.2	66.3	64.5	55.6	44.6	40.7	34.0	28.2	25.2	12
14	64.3	64.3	64.3	61.7	59.4	57.0	54.9	52.3	41.4	38.1	31.7	26.6	24.0	14
16	53.4	53.5	53.4	53.1	51.2	49.3	47.5	45.8	38.8	36.2	29.9	25.0	22.5	16
18	45.5	45.5	45.5	45.3	44.9	43.2	41.7	40.2	36.0	34.3	28.5	23.7	21.3	18
20	39.3	39.5	39.4	39.2	39.0	38.3	37.0	35.7	33.7	32.6	27.0	22.6	20.4	20
26		27.4	27.5	27.3	27.1	26.8	26.5	26.1	25.1	24.2	23.2	19.9	17.7	26
32			20.4	20.3	20.1	19.8	19.5	19.1	18.8	18.3	17.5	16.5	16.1	32
38				15.6	15.5	15.2	14.9	14.5	14.2	13.8	13.3	12.5	12.1	38
44					12.1	11.9	11.7	11.3	11.0	10.6	10.3	9.6	9.3	44
50						9.4	9.2	8.8	8.5	8.1	7.8	7.4	7.1	50
55							7.5	7.2	6.9	6.5	6.2	5.8	5.6	55
60								5.8	5.5	5.2	4.8	4.4	4.3	60
65									4.4	4.0	3.7	3.3	3.1	65
70										3.0	2.7	2.3	2.2	70

TLT 10576478 - M00000

Oben angeführte Traglastwerte sind nur zur Information. Für Ihren aktuellen Hub verwenden Sie bitte die Traglastwerte aus dem Traglasttabellenbuch.

Leichtausleger (No. 2320/1916.xx) **66 m - 117 m**

Arbeitsbereich **86° - 15°**

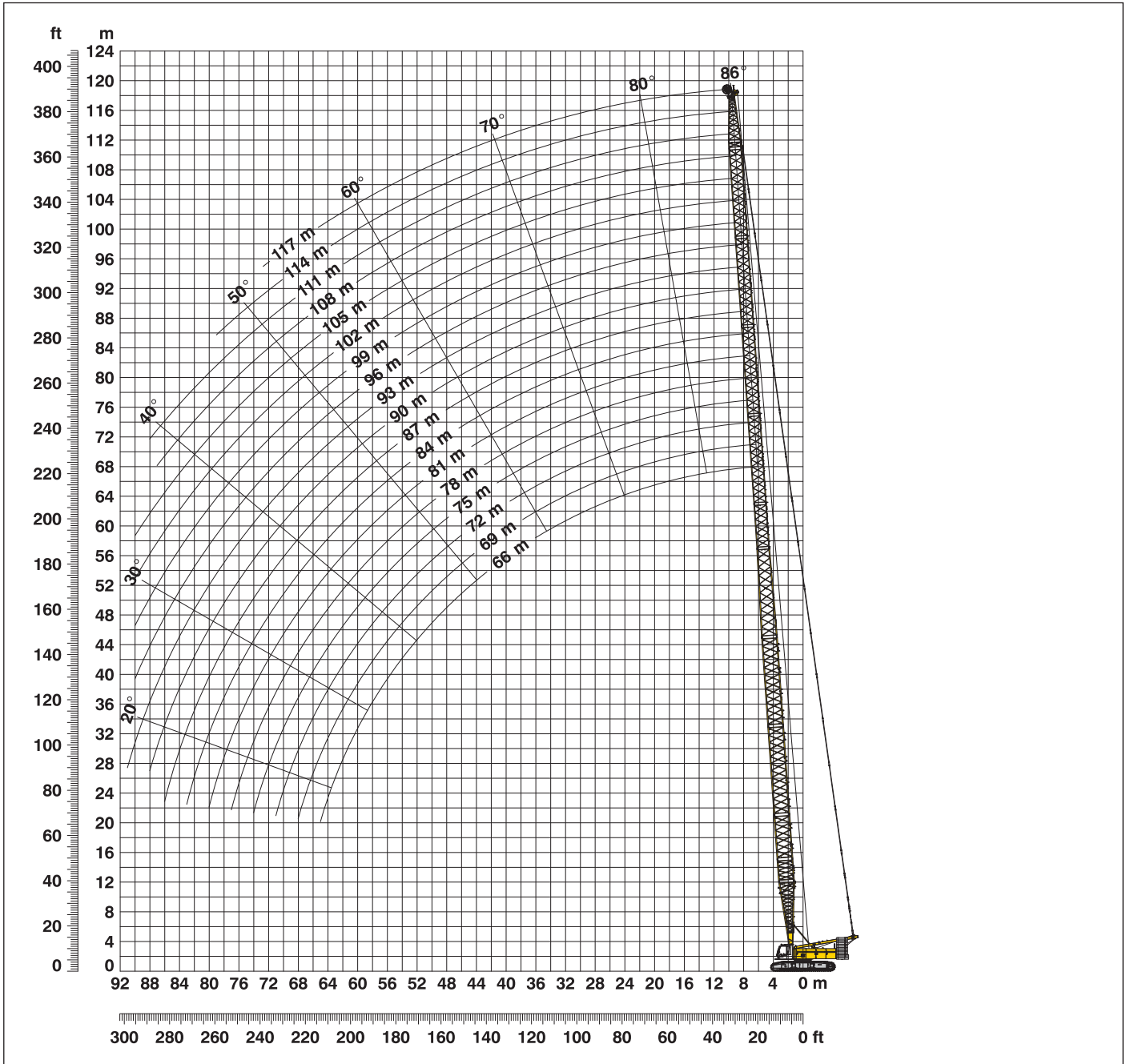

Leichtausleger-Zusammenbau mit 43 m Hauptausleger (No. 2320.xx/1916.xx)

Auslegerzusammenbau für Leichtauslegerlängen von 60.5 m bis 92.6 m

Anlenkstück	Länge	Anzahl der Haupt- und Nadelauslegerstücke																		
		66	69	72	75	78	81	84	87	90	93	96	99	102	105	108	111	114	117	
Anlenkstück	10 m	1	1	1	1	1	1	1	1	1	1	1	1	1	1	1	1	1	1	1
Z-Stück	3 m	1	1	1	1	1	1	1	1	1	1	1	1	1	1	1	1	1	1	1
Z-Stück	6 m	1	1	1	1	1	1	1	1	1	1	1	1	1	1	1	1	1	1	1
Z-Stück	12 m	2	2	2	2	2	2	2	2	2	2	2	2	2	2	2	2	2	2	2
Reduzierstück	12 m	1	1	1	1	1	1	1	1	1	1	1	1	1	1	1	1	1	1	1
Nadel-Z-Stück	3 m	1		1		1		1		1		1		1		1		1		1
Nadel-Z-Stück	6 m		1	1		1		1		1		1		1		1		1		1
Nadel-Z-Stück	12 m				1	1	1	1	2	2	2	2	3	3	3	3	4	4	4	4
Nadelkopfstück	8 m	1	1	1	1	1	1	1	1	1	1	1	1	1	1	1	1	1	1	1
Max. Leichtauslegerlänge (m)		66	69	72	75	78	81	84	87	90	93	96	99	102	105	108	111	114	117	

Traglasten - Leichtausleger (No. 2320/1916.xx)

Hauptausleger 43 m

Traglasten in Tonnen (t) 82.3 t Ballast und 36 t Zentralballast						
Radius	Auslegerlänge (m)					
	66	75	90	99	108	117
(m)	t	t	t	t	t	t
8.9	52.6					
10	51.6	36.7				
12	48.0	34.0	22.0			
14	43.8	31.7	20.5	14.9	11.5	
16	39.3	29.5	19.1	13.8	10.9	8.2
18	35.3	27.8	17.9	12.9	10.1	7.7
20	31.7	26.1	16.7	12.1	9.5	7.2
22	29.2	24.5	15.9	11.3	8.9	6.8
24	26.6	23.4	14.9	10.8	8.3	6.4
26	24.5	21.7	14.2	10.2	8.0	6.0
28	22.9	20.3	13.6	9.8	7.6	5.7
30	21.0	19.1	13.0	9.4	7.3	5.5
32	19.5	18.0	12.5	9.1	7.0	5.2
34	18.3	16.8	12.0	8.7	6.8	5.0
36	17.2	15.8	11.7	8.4	6.5	4.9
38	16.3	14.9	11.3	8.1	6.2	4.7
40	15.5	14.2	10.9	7.9	6.0	4.5
42	14.8	13.3	10.6	7.6	5.8	4.3
44	14.1	12.6	10.3	7.3	5.7	4.1
46	13.2	12.0	10.0	7.0	5.4	4.0
48	12.5	11.5	9.7	6.8	5.2	3.9
50	11.9	11.0	9.3	6.6	5.0	3.7
55	10.3	9.7	8.4	6.0	4.7	3.4
60	8.9	8.7	7.6	5.4	4.2	3.1
65	7.6	7.6	6.6	5.0	3.8	2.7
70		6.5	5.9	4.5	3.5	2.4
75			5.0	4.1	3.2	2.2
80			4.4	3.6	3.0	
85			3.7	3.2	2.7	
90				2.8	2.1	
95				2.3		

TLT 10576478 - M00000

Hauptausleger 55 m

Traglasten in Tonnen (t) 82.3 t Ballast und 36 t Zentralballast						
Radius	Auslegerlänge (m)					
	78	90	96	102	108	114
(m)	t	t	t	t	t	t
10.2	37.8					
12	35.6	24.8				
14	33.0	23.3	20.7	16.7	13.9	
16	30.9	21.9	19.4	15.6	13.1	10.9
18	29.0	20.6	18.5	14.6	12.2	10.2
20	27.3	19.5	17.4	13.8	11.6	9.6
22	25.4	18.6	16.6	13.0	10.9	9.1
24	23.9	17.8	15.9	12.3	10.3	8.6
26	22.3	17.1	15.3	11.8	9.9	8.2
28	20.4	16.5	14.8	11.3	9.5	7.9
30	18.8	15.8	14.4	10.9	9.1	7.5
32	17.6	14.9	13.8	10.6	8.8	7.2
34	16.3	14.2	13.1	10.2	8.6	7.0
36	15.1	13.6	12.5	9.8	8.2	6.8
38	14.0	12.9	12.0	9.5	7.9	6.6
40	13.2	12.0	11.5	9.3	7.7	6.3
42	12.6	11.2	10.7	9.0	7.4	6.1
44	12.0	10.5	10.0	8.5	7.3	5.9
46	11.5	9.9	9.3	8.1	7.0	5.8
48	11.0	9.4	8.8	7.7	6.7	5.6
50	10.6	9.0	8.3	7.4	6.4	5.4
55	9.1	8.1	7.4	6.6	5.9	5.1
60	8.0	7.2	6.7	5.9	5.2	4.7
65	6.8	6.2	5.8	5.3	4.6	4.1
70	5.9	5.4	5.0	4.5	4.1	3.7
75	5.0	4.6	4.3	3.8	3.4	3.2
80		3.9	3.6	3.2	2.9	2.5
85		3.3	3.1	2.6	2.4	2.0
90			2.5	2.2		

TLT 10576478 - M00000

Oben angeführte Traglastwerte sind nur zur Information. Für Ihren aktuellen Hub verwenden Sie bitte die Traglastwerte aus dem Traglasttabellenbuch.

Leichtausleger-Zusammenbau mit 55 m Hauptausleger (No. 2320.xx/1916.xx)

Auslegerzusammenbau für Leichtauslegerlängen von 72.5 m bis 92.9 m														
	Länge	Anzahl der Haupt- und Nadelauslegerstücke												
		Anlenkstück	10 m	1	1	1	1	1	1	1	1	1	1	1
Z-Stück	3 m	1	1	1	1	1	1	1	1	1	1	1	1	1
Z-Stück	6 m	1	1	1	1	1	1	1	1	1	1	1	1	1
Z-Stück	12 m	3	3	3	3	3	3	3	3	3	3	3	3	3
Reduzierstück	12 m	1	1	1	1	1	1	1	1	1	1	1	1	1
Nadel-Z-Stück	3 m	1		1		1		1		1		1		1
Nadel-Z-Stück	6 m		1	1			1	1			1	1		
Nadel-Z-Stück	12 m				1	1	1	1	2	2	2	2	3	3
Nadelkopfstück	8 m	1	1	1	1	1	1	1	1	1	1	1	1	1
Max. Leichtauslegerlänge (m)		78	81	84	87	90	93	96	99	102	105	108	111	114

Verstellb. Nadelausleger (No. 1916.xx) 78° - 15°

Hauptausleger 88° - 45°

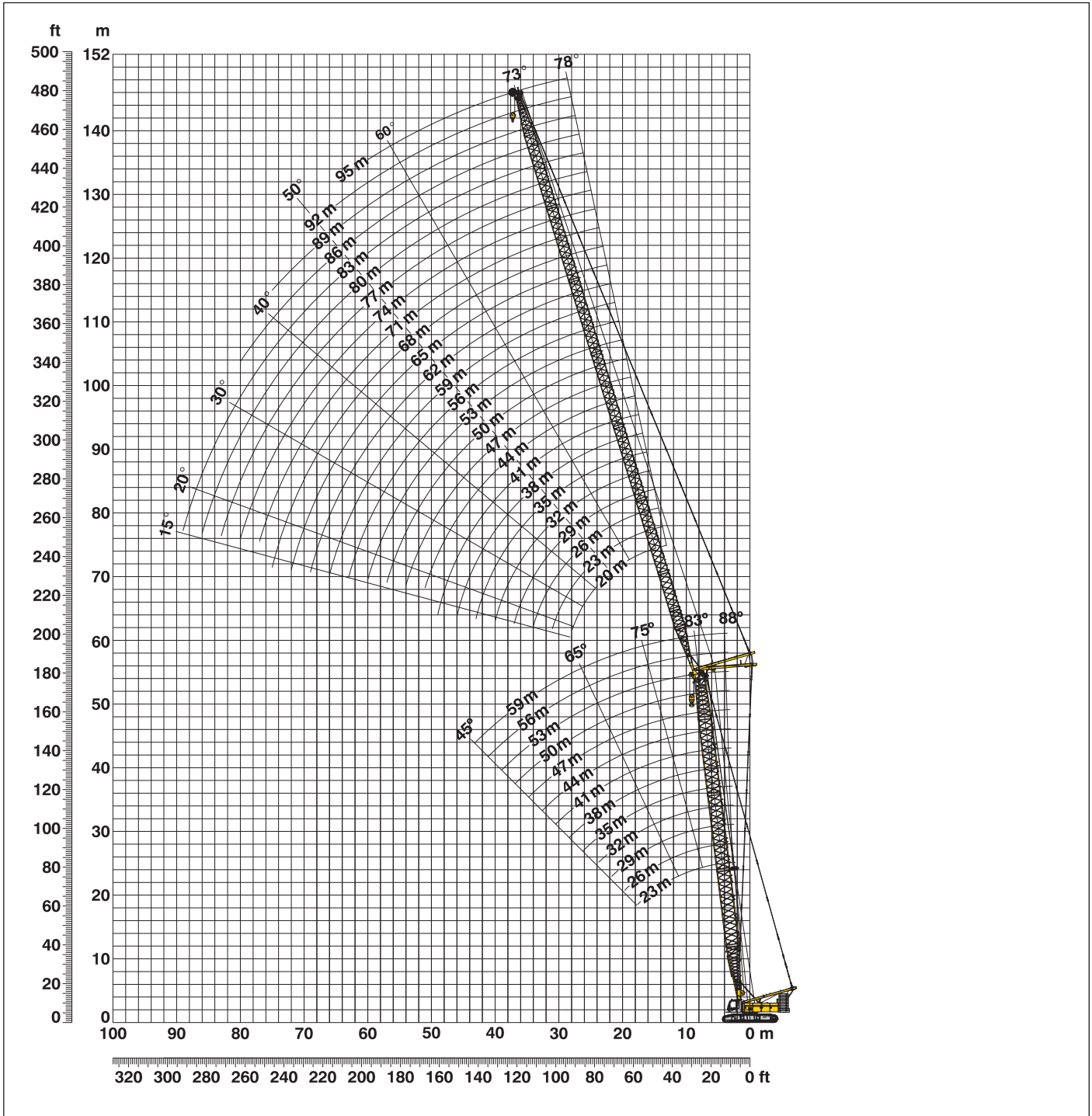

Auslegerzusammenbau für Hauptauslegerlängen von 23 m - 59 m – siehe Tabelle 1, Seite 10

Konfiguration mit verstellbarem Nadelausleger (20 m - 95 m)

	Länge	Anzahl der Nadelauslegerstücke																									
		20	23	26	29	32	35	38	41	44	47	50	53	56	59	62	65	68	71	74	77	80	83	86	89	92	95
Nadelanlenkstück	7 m	1	1	1	1	1	1	1	1	1	1	1	1	1	1	1	1	1	1	1	1	1	1	1	1	1	1
Nadel-Z-Stück	3 m			1	1	1	1	1	1	1	1	1	1	1	1	1	1	1	1	1	1	1	1	1	1	1	1
Nadel-Z-Stück	6 m	1	1			1	1			1	1			1	1			1	1			1	1			1	1
Nadel-Z-Stück	12 m			1	1	1	1	2	2	2	2	3	3	3	3	4	4	4	4	5	5	5	5	6	6	6	6
Nadelkopfstück	7 m	1	1	1	1	1	1	1	1	1	1	1	1	1	1	1	1	1	1	1	1	1	1	1	1	1	1
Nadellänge (m)		20	23	26	29	32	35	38	41	44	47	50	53	56	59	62	65	68	71	74	77	80	83	86	89	92	95

Traglasten - verstellb. Nadelausleger (No.1916.xx)

Hauptausleger 88°

Hauptausleger 23 m

Radius (m)	Nadellänge (m)							
	20	29	41	53	62	71	83	95
7.9	t	t	t	t	t	t	t	t
10	69.9							
13	57.2	52.0						
15	44.4	40.9	36.0					
17	38.1	35.5	31.7	25.5				
19	33.6	31.4	27.9	23.7	18.2			
22	29.8	27.9	25.1	21.7	17.6	12.9		
26	25.8	24.0	21.5	18.9	16.1	12.4	8.4	
30		20.2	18.3	16.2	14.1	11.7	8.1	5.1
42		17.8	16.0	14.3	12.4	10.9	7.8	5.0
50			11.6	10.3	9.1	8.1	6.7	4.4
60				8.6	7.5	6.8	5.5	4.0
65					6.1	5.3	4.3	3.1
70						4.8	3.8	2.8
75						4.3	3.3	2.3
80							2.9	
							2.6	

Hauptausleger 35 m

Radius (m)	Nadellänge (m)							
	20	29	41	53	62	71	83	95
8.3	t	t	t	t	t	t	t	t
11	65.1							
13	54.2	47.6						
16	46.9	41.8	32.7					
18	38.9	35.2	29.6	21.6				
19	35.0	32.0	27.0	20.9	15.5			
22	33.2	30.3	26.0	20.6	15.3	11.2		
26	29.1	26.3	22.6	18.8	14.7	10.9	7.3	
32		22.7	19.7	16.6	13.9	10.6	7.1	4.4
42		12.1	16.7	14.3	12.5	10.1	7.0	4.4
46			13.2	11.5	10.3	8.8	6.4	4.1
55				10.6	9.6	8.2	6.1	3.9
60				8.6	8.1	7.0	5.5	3.4
70					7.3	6.3	5.0	3.1
75						5.1	4.0	2.6
80							3.6	2.3
							3.1	2.0

Hauptausleger 44 m

Radius (m)	Nadellänge (m)							
	20	29	41	53	62	71	83	95
8.7	t	t	t	t	t	t	t	t
11	50.1							
13	44.8	38.0						
16	40.3	34.7	26.7					
18	34.7	30.4	24.5	18.4				
20	31.8	28.2	22.7	17.6	13.3			
22	29.0	25.8	21.2	16.6	13.1	9.9		
26	26.8	23.9	19.8	15.6	12.8	9.7	6.4	
32		20.8	17.7	14.2	11.8	9.4	6.3	3.7
36		17.6	15.3	12.7	10.8	8.9	6.3	3.7
44			11.3	10.0	8.9	7.5	5.6	3.5
48				9.3	8.2	7.1	5.3	3.4
55				7.6	7.1	6.1	4.8	3.0
60					6.4	5.5	4.4	2.7
70						4.5	3.3	2.1
80							2.5	

Hauptausleger 53 m

Radius (m)	Nadellänge (m)							
	20	29	41	53	62	71	83	95
9	t	t	t	t	t	t	t	t
11	38.7							
14	35.3	29.5						
16	30.7	26.1	20.6					
18	28.1	24.0	19.4	14.8				
20	26.0	22.2	17.9	14.2	11.4			
24	24.0	20.5	16.7	13.4	11.1	8.4		
26	12.1	18.1	14.6	11.9	10.1	8.1	5.3	
32		17.2	13.9	11.4	9.7	7.9	5.3	3.1
36		15.5	12.4	10.3	8.8	7.2	5.1	3.1
44			11.6	9.6	8.2	6.7	4.9	3.1
48			10.0	8.5	7.2	5.9	4.3	2.7
55				8.0	6.8	5.5	4.0	2.5
60				7.0	6.1	4.9	3.5	2.1
70					5.6	4.5	3.2	
75						3.7	2.5	
							2.2	

Hauptausleger 56 m

Radius (m)	Nadellänge (m)							
	20	29	35	41	53	62	71	80
9.1	t	t	t	t	t	t	t	t
11	37.2							
13	34.9	28.4						
14	31.8	26.9	23.7					
16	30.6	25.7	22.9	20.0				
18	28.1	23.8	21.4	18.8	14.4			
20	26.2	22.1	20.0	17.6	13.9	10.9		
22	24.3	20.6	18.7	16.6	13.2	10.8	8.0	
24	22.9	19.2	17.7	15.5	12.4	10.5	7.9	5.9
32	12.1	18.2	16.7	14.7	11.8	10.0	7.8	5.8
38		15.3	14.0	12.5	10.3	8.7	7.1	5.7
44			12.4	11.1	9.4	8.0	6.5	5.2
55				9.7	8.3	7.3	5.9	4.8
60					6.8	5.9	4.9	4.0
70						5.4	4.4	3.5
80							3.5	2.7
								2.0

Hauptausleger 59 m

Radius (m)	Nadellänge (m)							
	20	29	35	41	53	62		
9.2	t	t	t	t	t	t		
12	32.9							
13	29.7	24.6						
14	28.3	23.7	20.9					
17	27.1	22.8	20.1	17.9				
18	24.1	20.4	18.2	16.2	12.9			
20	23.3	19.7	17.5	15.7	12.5	10.1		
24	21.6	18.4	16.2	14.8	11.8	9.9		
28	12.1	16.3	14.3	13.0	10.6	8.9		
32		15.0	13.1	11.9	9.7	8.2		
38		14.1	12.2	11.1	9.1	7.7		
42			11.2	10.1	8.2	7.0		
44				9.5	7.7	6.5		
48				8.9	7.5	6.3		
55					7.1	6.0		
60					6.3	5.4		
						4.9		

TLT 10576478 - M0000

Traglasten in Tonnen mit verstellbarem Nadelausleger (No. 1916.xx), 82,3 Ballast + 36 t Zentralballast. Oben angeführte Traglastwerte sind nur zur Information. Für Ihren aktuellen Hub verwenden Sie bitte die Traglastwerte aus dem Traglasttabellenbuch.

Traglasten - verstellb. Nadelausleger (No. 1916.xx)

Hauptausleger 83°

Hauptausleger 23 m

Radius (m)	Nadellänge (m)							
	20	29	41	53	62	71	83	95
11.7	t	t	t	t	t	t	t	t
15	57.6							
18	43.7	41.1						
22	35.4	33.1	29.6					
24	28.1	26.3	24.0	21.2				
28	25.5	24.0	21.8	19.3	15.9			
32		20.3	18.6	16.6	14.6	11.8		
34		17.8	16.3	14.7	12.9	11.3	7.9	
44			15.2	13.7	12.3	10.7	7.7	5.0
48			11.6	10.4	9.4	8.4	6.9	4.5
55				9.4	8.4	7.7	6.3	4.2
60				8.1	7.1	6.5	5.4	3.8
65					6.4	5.7	4.8	3.4
70					5.7	5.1	4.1	3.1
75						4.6	3.6	2.7
85							3.2	2.2

Hauptausleger 35 m

Radius (m)	Nadellänge (m)							
	20	29	41	53	62	71	83	95
13.1	t	t	t	t	t	t	t	t
16	55.3							
20	45.7	41.0						
24	36.2	32.9	28.3					
26	29.8	27.3	23.8	19.3				
28	27.7	25.4	22.1	18.6	14.3			
32		23.7	20.8	17.8	14.1	10.6		
34		21.1	18.5	16.0	13.4	10.5	7.1	
36		20.0	17.6	15.2	13.1	10.3	7.1	
40			16.6	14.4	12.8	10.1	7.0	4.4
46			15.1	13.2	11.8	9.8	6.7	4.3
50			13.2	11.5	10.6	9.0	6.4	4.1
55				10.7	9.7	8.5	6.1	3.9
65				9.7	8.8	7.8	5.8	3.6
75					7.4	6.5	5.1	3.1
85						5.4	4.2	2.5

Hauptausleger 44 m

Radius (m)	Nadellänge (m)							
	20	29	41	53	62	71	83	95
14.2	t	t	t	t	t	t	t	t
17	40.8							
22	36.1	31.3						
24	29.1	26.0	21.4					
26	27.0	24.1	20.1	15.7				
28	25.7	22.8	19.1	15.3				
30		21.6	18.3	14.7	12.2			
34		20.6	17.5	14.2	11.9	9.4		
36		19.0	16.3	13.3	11.3	9.2	6.2	
40		12.1	15.6	12.8	11.0	9.1	6.2	
46			14.3	12.1	10.4	8.6	6.2	3.7
50			12.9	10.8	9.5	8.0	5.8	3.6
55				10.1	8.9	7.6	5.5	3.5
65				9.4	8.2	7.0	5.2	3.3
75					7.0	6.0	4.5	2.8
85						5.1	3.8	2.3

Hauptausleger 53 m

Radius (m)	Nadellänge (m)							
	20	29	41	53	62	71	83	95
9	t	t	t	t	t	t	t	t
11	38.7							
14	35.3	29.5						
16	30.7	26.1	20.6					
18	28.1	24.0	19.4	14.8				
20	26.0	22.2	17.9	14.2	11.4			
24	24.0	20.5	16.7	13.4	11.1	8.4		
26	12.1	18.1	14.6	11.9	10.1	8.1	5.3	
32		17.2	13.9	11.4	9.7	7.9	5.3	3.1
36		15.5	12.4	10.3	8.8	7.2	5.1	3.1
44			11.6	9.6	8.2	6.7	4.9	3.1
48			10.0	8.5	7.2	5.9	4.3	2.7
55				8.0	6.8	5.5	4.0	2.5
60				7.0	6.1	4.9	3.5	2.1
70					5.6	4.5	3.2	
75						3.7	2.5	

Hauptausleger 56 m

Radius (m)	Nadellänge (m)							
	20	29	35	41	53	62	71	80
15.7	t	t	t	t	t	t	t	t
19	31.4							
22	27.8	23.6						
26	24.9	21.2	19.2	16.6				
28	22.3	19.0	17.3	15.2	12.1			
32	21.3	18.2	16.6	14.6	11.8	9.8		
34		16.8	15.5	13.6	11.1	9.4	7.6	
36		16.3	14.9	13.2	10.8	9.2	7.5	5.6
40		15.7	14.4	12.8	10.5	8.9	7.3	5.6
42			13.5	11.9	9.9	8.5	6.9	5.6
48			13.0	11.5	9.7	8.3	6.7	5.4
55				10.5	8.8	7.6	6.2	5.0
60					8.0	6.8	5.6	4.5
65					7.4	6.3	5.2	4.2
75						5.9	4.8	3.8
85							4.1	3.2

Hauptausleger 59 m

Radius (m)	Nadellänge (m)							
	20	29	35	41	53	62		
16	t	t	t	t	t	t		
19	27.4							
22	24.6	20.9						
24	21.9	18.8	16.8					
26	20.7	17.7	15.7	14.2				
28	19.6	16.8	14.9	13.6	10.9			
30	18.9	16.1	14.2	13.0	10.6			
34		15.5	13.6	12.6	10.3	8.7		
38		14.5	12.7	11.7	9.7	8.2		
42		12.1	12.0	10.9	9.0	7.7		
46			11.4	10.3	8.5	7.2		
48				9.8	8.0	6.8		
55				9.5	7.7	6.6		
60					7.1	5.9		
65					6.6	5.5		
70						5.1		

TLT 10576478 - M00000

Traglasten in Tonnen mit verstellbarem Nadelausleger (No. 1916.xx), 82.3 Ballast + 36 t Zentralballast. Oben angeführte Traglastwerte sind nur zur Information. Für Ihren aktuellen Hub verwenden Sie bitte die Traglastwerte aus dem Traglasttabellenbuch.

Traglasten - verstellb. Nadelausleger (No. 1916.xx)

Hauptausleger 75°

Hauptausleger 23 m

Radius (m)	Nadellänge (m)							
	20	29	41	53	62	71	83	95
17.4	t							
22	24.0							
28	12.1	23.4	21.9					
32		19.9	18.6	17.1				
36		17.4	16.2	15.0	13.6			
40			14.2	13.1	12.0	10.5		
44			12.8	11.7	10.7	9.7	7.0	
48			11.4	10.5	9.6	8.8	6.7	
50				9.9	9.1	8.3	6.6	4.3
55				8.8	7.9	7.4	6.1	4.0
60				6.9	7.1	6.4	5.5	3.7
65					6.3	5.7	4.9	3.3
70						5.1	4.2	3.1
75						4.5	3.7	2.6
80							3.2	2.3
85							2.8	

Hauptausleger 35 m

Radius (m)	Nadellänge (m)							
	20	29	41	53	62	71	83	95
20.5	t							
26	24.0							
30	31.0	29.9						
36	25.9	25.6	23.7					
40		20.5	19.6	17.4				
44		12.1	17.5	15.7	13.1			
48			15.4	14.1	12.7	9.8		
50			13.8	12.8	11.7	9.5	6.4	
55			13.0	12.2	11.3	9.3	6.3	
60				10.9	10.2	8.9	6.1	3.8
65				9.6	9.2	8.3	5.8	3.6
70					8.2	7.5	5.6	3.3
75					7.3	6.8	5.3	3.1
80						6.0	4.9	2.8
85						5.3	4.6	2.6
90							4.2	2.3
							3.6	2.1

Hauptausleger 44 m

Radius (m)	Nadellänge (m)							
	20	29	41	53	62	71	83	95
22.8	t							
28	24.0							
32	26.0	23.3						
38	23.0	21.3	18.0					
42		18.3	16.2	13.5				
46		16.0	15.2	12.7	10.8			
48			13.8	11.9	10.4	8.4		
50			13.1	11.7	10.1	8.3		
55			12.4	11.3	9.8	8.2	5.7	
60				10.3	9.2	7.7	5.5	3.4
65				9.1	8.5	7.4	5.3	3.3
70				8.0	7.7	6.8	5.0	3.1
75					6.8	6.2	4.7	2.8
80						5.5	4.4	2.6
85						4.9	4.1	2.3
90							3.5	2.1

Hauptausleger 53 m

Radius (m)	Nadellänge (m)							
	20	29	41	53	62	71	83	95
25.2	t							
30	24.0							
34	21.6	18.6						
36	20.0	17.1	13.8					
40	12.1	16.6	13.6					
44		15.5	12.7	10.6				
48		14.3	11.9	10.1	8.6			
55			11.2	9.5	8.2	6.7		
60			10.1	8.6	7.5	6.2	4.5	
65				8.1	6.9	5.7	4.2	2.5
70				7.4	6.4	5.3	3.9	2.4
75					6.0	4.9	3.6	2.1
80					5.4	4.6	3.3	
85						4.1	3.0	
90						3.6	2.8	
95							2.4	

Hauptausleger 56 m

Radius (m)	Nadellänge (m)							
	20	29	35	41	53	62	71	80
26	t							
30	24.1							
34	21.9	18.8						
36	19.3	17.7	16.2					
40	18.2	17.1	15.7	13.7				
44		15.4	14.7	12.9	10.6			
48		13.9	13.3	12.3	10.2	8.4		
50			12.0	11.5	9.7	8.3	6.5	
55			11.5	11.0	9.5	8.1	6.5	
60				9.8	8.8	7.6	6.2	4.9
65					7.8	7.1	5.8	4.7
70					7.0	6.4	5.5	4.4
75						5.7	4.9	4.1
80						5.1	4.3	3.7
85							3.8	3.2
90							3.4	2.8

Hauptausleger 59 m

Radius (m)	Nadellänge (m)							
	20	29	35	41	53	62		
26.7	t							
32	20.4							
34	19.2	16.3						
36	18.6	15.7	13.8					
40	17.6	15.2	13.4	12.0				
42		14.8	12.9	11.8				
44		14.3	12.5	11.5				
46		13.9	12.2	11.1	9.1			
48		13.4	11.8	10.8	8.9			
50		12.1	11.5	10.5	8.7	7.3		
55			11.3	10.2	8.4	7.2		
60			11.0	10.0	8.2	7.0		
65				9.4	7.8	6.6		
70					7.3	6.2		
75					6.7	5.8		

TLT 10576478 - M0000

Traglasten in Tonnen mit verstellbarem Nadelausleger (No. 1916.xx), 82,3 Ballast + 36 t Zentralballast. Oben angeführte Traglastwerte sind nur zur Information. Für Ihren aktuellen Hub verwenden Sie bitte die Traglastwerte aus dem Traglasttabellenbuch.

Traglasten - verstellb. Nadelausleger (No. 1916.xx)

Hauptausleger 65°

Hauptausleger 23 m

Radius (m)	Nadellänge (m)							
	20	29	41	53	62	71	83	95
24.1	t	t	t	t	t	t	t	t
30	24.0							
32	25.7	25.4						
38	12.1	23.5						
40		18.7	18.0					
44		17.3	16.7					
44			14.5	13.9				
50			12.2	11.5	10.6			
55				9.9	9.3	8.3		
60				8.7	8.0	7.5		
65					7.1	6.6	5.5	
70					6.2	5.8	5.1	3.3
75						5.1	4.4	3.0
80						4.5	3.9	2.7
85							3.4	2.4
90							2.8	2.2

Hauptausleger 35 m

Radius (m)	Nadellänge (m)							
	20	29	41	53	62	71	83	95
29.2	t	t	t	t	t	t	t	t
32	24.0							
32	21.9							
36	18.8	18.5						
42		15.2	14.6					
44		14.3	13.7					
50			11.6	11.0				
55				10.1	9.6	9.1		
60					8.4	8.0	7.4	
65					7.4	7.0	6.5	
70						6.2	5.7	4.8
75						5.5	5.0	4.2
80							4.3	3.7
85							3.8	3.2
90								2.7
95								2.3

Hauptausleger 44 m

Radius (m)	Nadellänge (m)						
	20	29	41	53	62	71	83
33	t	t	t	t	t	t	t
33	19.4						
40	15.2	14.7					
46		12.3	11.7				
48		11.6	11.0				
55			9.1	8.4			
60			8.0	7.4	6.7		
65				6.5	5.9	5.2	
70				5.7	5.3	4.5	3.6
75					4.7	3.9	3.0
80					4.1	3.4	2.6
85						3.0	2.1
90							2.5

Hauptausleger 53 m

Radius (m)	Nadellänge (m)						
	20	29	41	53	62	71	
36.8	t	t	t	t	t	t	
36.8	15.0						
42	12.9	12.1					
44	12.1	11.5					
48		10.3					
50		9.8	8.8				
55			7.8				
60			6.9	5.9			
65			6.1	5.2	4.6		
70				4.6	4.0	3.2	
75				4.1	3.5	2.7	
80					3.0	2.3	
85						2.6	

Hauptausleger 56 m

Radius (m)	Nadellänge (m)						
	20	29	35	41	53	62	71
38.1	t	t	t	t	t	t	t
38.1	13.7						
44	11.6	10.8					
46	10.9	10.2					
48		9.7	9.1				
55			7.6	7.2			
60			6.8	6.4	5.4		
65				5.6	4.7	4.1	
70					4.1	3.5	2.7
75					3.6	3.0	2.3
80						2.6	
85							2.2

Hauptausleger 59 m

Radius (m)	Nadellänge (m)						
	20	29	35	41	53	62	
39.4	t	t	t	t	t	t	
39.4	12.4						
44	10.9						
46	10.4	9.5					
48		9.1	8.4				
50		8.6	8.0				
55		7.6	7.1	6.6			
60			6.3	5.8	4.9		
65				5.2	4.2	3.6	
70					3.7	3.0	
75					3.2	2.6	
80						2.2	

TLT 10576478 - M00000

Traglasten in Tonnen mit verstellbarem Nadelausleger (No. 1916.xx), 82.3 Ballast + 36 t Zentralballast. Oben angeführte Traglastwerte sind nur zur Information. Für Ihren aktuellen Hub verwenden Sie bitte die Traglastwerte aus dem Traglasttabellenbuch.

Traglasten - verstellb. Nadelausleger (No. 1916.xx)

Hauptausleger 45°

Hauptausleger 23 m

Radius (m)	Nadellänge (m)						
	20	29	41	53	62	71	83
	t	t	t	t	t	t	t
35.4	18.9						
38	17.3						
44		14.0					
46		13.2					
55			9.9				
65				7.2			
70				6.3	5.9		
75					5.2		
80						4.1	
85						3.6	
90							2.6
95							2.1

Hauptausleger 35 m

Radius (m)	Nadellänge (m)					
	20	29	41	53	62	
	t	t	t	t	t	
43.8	12.0					
44	12.0					
46	11.3					
55		8.4				
60						
65			6.0			
75				4.0		
80					3.1	
85					2.7	

Hauptausleger 44 m

Radius (m)	Nadellänge (m)			
	20	29	41	53
	t	t	t	t
50.2	8.2			
60		5.8		
70			3.9	
80				2.3

Hauptausleger 53 m

Radius (m)	Nadellänge (m)	
	20	29
	t	t
56.6	5.2	
65		3.6

Hauptausleger 56 m

Radius (m)	Nadellänge (m)	
	20	29
	t	t
58.7	4.3	
60	4.1	
70		2.5

Hauptausleger 59 m

Radius (m)	Nadellänge (m)
	20
	t
60.8	3.4

TLT 10576478 - M00000

Traglasten in Tonnen mit verstellbarem Nadelausleger (No. 1916.xx), 82.3 Ballast + 36 t Zentralballast. Oben angeführte Traglastwerte sind nur zur Information. Für Ihren aktuellen Hub verwenden Sie bitte die Traglastwerte aus dem Traglasttabellenbuch.

Feststehender Nadelausleger (No. 1008.xx) 15° - 30°

Hauptausleger 88° - 30°

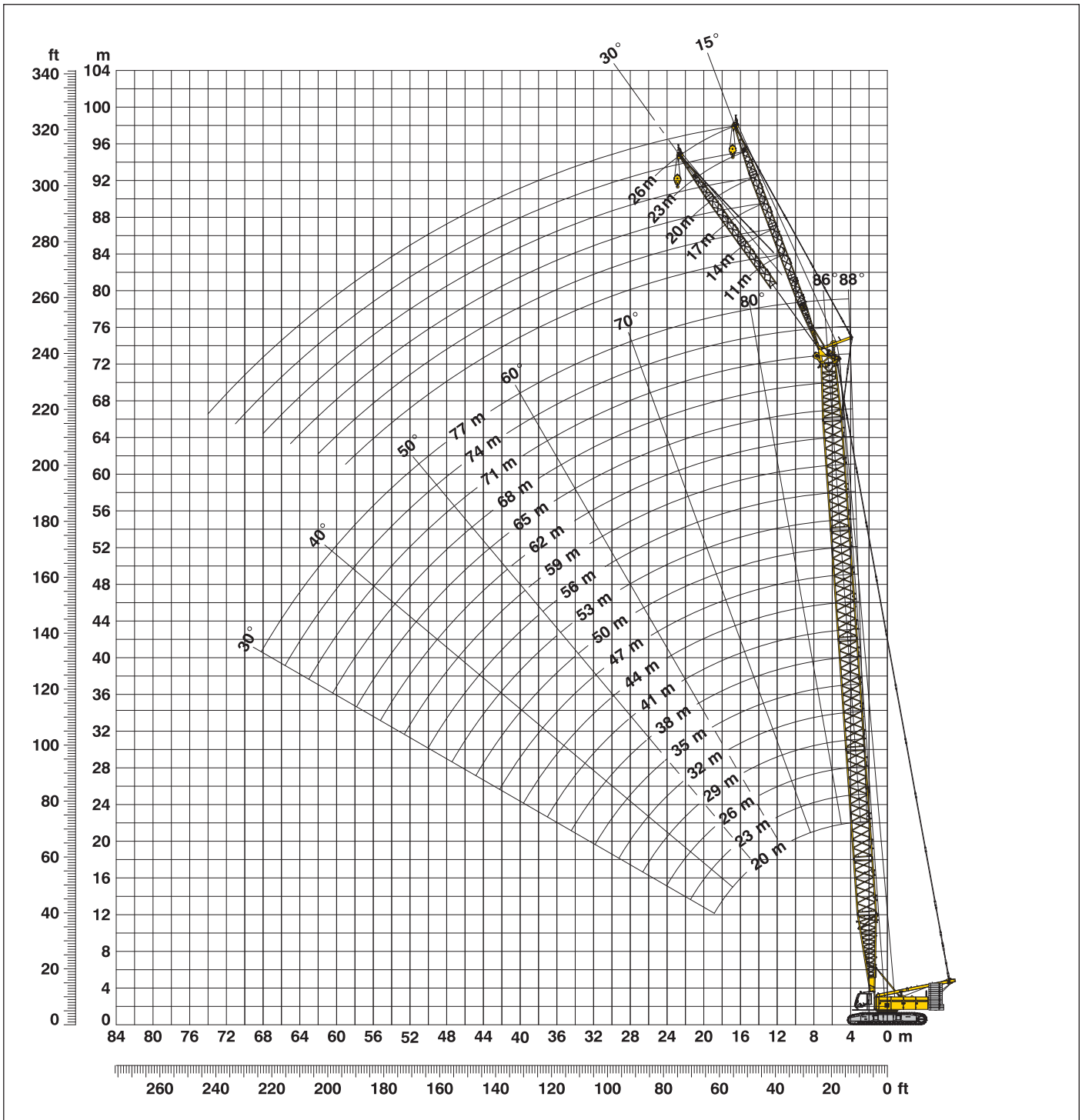

Auslegerzusammenbau für Hauptauslegerlängen von 20 m - 77 m – siehe Tabelle 1, Seite 10

Konfiguration mit feststehendem Nadelausleger (11 m - 26 m)

	Länge	Anzahl der Nadelauslegerstücke					
Nadelanlenkstück	5.5 m	1	1	1	1	1	1
Nadel-Z-Stück	3 m		1		1		1
Nadel-Z-Stück	6 m			1	1	2	2
Nadelkopfstück	5.5 m	1	1	1	1	1	1
Nadellänge (m)		11	14	17	20	23	26

Traglasten - festst. Nadelausleger (No. 1008.xx)

Offset 15°

Hauptausleger 20 m

Radius	Fixed jib length in (m)			
	11	14	20	26
(m)	t	t	t	t
9	35.9	35.5		
11	35.9	34.0	28.9	
12	35.9	33.2	27.7	19.8
14	35.9	31.5	25.5	18.3
16	35.1	29.9	23.9	17.1
20	32.8	26.5	20.0	15.1
24	27.5	23.2	17.0	13.4
28	24.0	20.7	14.8	11.7
30	23.0	19.5	13.8	11.1
32		18.4	13.0	10.5
38			11.3	9.0
44				7.9

Hauptausleger 29 m

Radius	Nadellänge (m)			
	11	14	20	26
(m)	t	t	t	t
8	35.9			
9	35.9	34.9		
10	35.9	34.2	28.3	
12	35.9	33.1	26.5	19.5
14	35.9	32.1	24.9	18.4
18	35.8	30.0	22.4	16.5
24	33.0	26.3	19.2	14.2
32	23.1	21.4	15.0	11.6
38	17.9	18.2	12.9	10.1
40		16.9	12.4	9.7
46			11.2	8.7
50				8.1

Hauptausleger 38 m

Radius	Nadellänge (m)			
	11	14	20	26
(m)	t	t	t	t
6.3	35.9			
8	35.9	35.4		
10	35.9	34.3	28.1	
13	35.9	33.0	26.0	18.6
18	35.9	31.3	22.9	16.5
24	33.4	29.0	20.1	14.6
32	22.5	22.8	16.8	12.6
40	16.0	16.3	14.1	10.7
46	12.7	13.0	12.7	9.5
48		12.1	12.3	9.2
55			9.9	8.3
60				7.8

Hauptausleger 47 m

Radius	Nadellänge (m)			
	11	14	20	26
(m)	t	t	t	t
6.6	35.9			
8	35.9	34.4		
11	35.9	33.2	26.2	
13	35.9	32.4	25.0	18.1
20	35.0	30.1	21.3	15.7
28	26.6	26.3	19.0	13.8
36	18.4	18.7	16.3	12.5
44	13.2	13.5	14.0	10.7
50	10.5	10.8	11.2	9.7
55		8.9	9.4	9.0
60			7.8	8.2
65				6.9

Hauptausleger 56 m

Radius	Nadellänge (m)			
	11	14	20	26
(m)	t	t	t	t
6.9	35.9			
9	35.9	33.5		
11	35.9	32.8	25.1	
13	35.9	32.0	24.2	17.2
18	33.3	29.5	22.0	15.8
24	29.7	26.7	19.8	14.3
32	21.4	21.8	18.1	13.2
40	15.0	15.2	15.7	12.1
48	10.8	11.0	11.5	10.6
60	6.6	6.9	7.3	7.7
70			4.9	5.2
75				4.2

Hauptausleger 62 m

Radius	Nadellänge (m)			
	11	14	20	26
(m)	t	t	t	t
7.1	35.9			
9	35.8	32.6		
11	35.2	31.7	23.8	
13	33.5	30.4	23.2	16.5
20	27.8	25.8	20.3	14.8
28	24.1	22.4	17.9	13.4
36	17.4	17.7	16.6	12.7
44	12.3	12.5	13.1	11.6
55	7.7	8.0	8.4	8.8
65	5.0	5.2	5.6	6.0
75			3.5	3.8
80				3.0

Hauptausleger 68 m

Radius	Nadellänge (m)			
	11	14	20	26
(m)	t	t	t	t
7.3	34.1			
9	33.7	30.2		
11	31.8	29.2	22.2	
14	28.3	26.7	21.4	15.7
18	24.7	23.8	19.6	14.8
24	21.1	20.3	17.5	13.6
32	18.7	18.0	15.7	12.6
40	14.2	14.5	14.3	11.9
48	10.0	10.3	10.8	10.7
65	4.6	4.8	5.2	5.6
75		2.8	3.2	3.5
80			2.3	2.6

Hauptausleger 74 m

Radius	Nadellänge (m)			
	11	14	20	23
(m)	t	t	t	t
7.6	29.0			
9	29.0	26.1		
12	26.1	24.6	20.2	
13	25.0	24.0	20.1	17.2
16	22.7	21.6	18.7	16.5
20	19.9	19.2	17.0	15.4
28	16.9	16.3	14.9	14.0
36	15.1	14.9	13.6	12.8
44	11.5	11.7	12.0	11.6
55	7.0	7.2	7.7	7.9
75	2.2	2.4	2.8	3.0
80				2.1

Hauptausleger 77 m

Radius	Nadellänge (m)			
	11	14	17	
(m)	t	t	t	
7.7	26.7			
9	26.7	23.8		
10	25.8	23.8	21.5	
12	24.2	22.5	21.3	
14	22.4	21.2	20.1	
16	21.0	19.8	18.9	
20	18.5	17.8	17.0	
28	15.7	15.0	14.4	
36	14.4	13.9	13.4	
44	11.2	11.4	11.5	
55	6.8	7.0	7.3	
75	2.1	2.2	2.5	

TLT 10576478 - M00000

Traglasten in Tonnen mit feststehendem Nadelausleger (No. 1008.xx), 82.3 Ballast + 36 t Zentralballast. Oben angeführte Traglastwerte sind nur zur Information. Für Ihren aktuellen Hub verwenden Sie bitte die Traglastwerte aus dem Traglasttabellenbuch.

Traglasten - festst. Nadelausleger (No. 1008.xx)

Offset 30°

Hauptausleger 20 m

Radius	Fixed jib length in (m)			
	11	14	20	26
(m)	t	t	t	t
11	34.8			
12	32.7	26.9		
14	29.8	24.7	17.5	
18	25.1	21.6	15.1	12.1
20	23.4	20.1	14.0	11.3
24	21.5	17.6	12.3	9.8
26	20.3	16.7	11.7	9.2
28	19.6	15.9	11.2	8.7
30	19.0	15.2	10.8	8.3
34		14.5	9.8	7.6
40			9.1	6.8
46				6.4

Hauptausleger 29 m

Radius	Nadellänge (m)			
	11	14	20	26
(m)	t	t	t	t
10	35.9			
12	34.6	27.8		
14	31.8	26.0		
15	30.7	25.0	17.3	
16	29.6	24.0	16.8	
18	27.5	23.5	15.6	12.0
24	23.2	19.5	13.1	10.2
32	20.2	16.2	11.1	8.5
38	18.0	14.9	10.0	7.6
44			9.4	7.0
46			9.3	6.8
50				6.6

Hauptausleger 38 m

Radius	Nadellänge (m)			
	11	17	20	26
(m)	t	t	t	t
8.9	35.9			
13	34.4	21.7		
15	32.2	20.6	17.8	
19	28.6	18.2	15.9	12.1
24	25.3	16.0	14.0	10.5
32	22.3	13.7	12.0	8.9
40	16.2	12.2	10.7	7.8
44	13.8	11.8	10.1	7.4
46	12.8	11.7	9.9	7.2
50		11.4	9.6	6.9
55			9.4	6.6
60				6.5

Hauptausleger 47 m

Radius	Nadellänge (m)			
	11	14	20	26
(m)	t	t	t	t
9.3	35.9			
12	35.7	28.0		
15	33.6	26.4	17.1	
19	30.1	23.9	15.9	12.0
20	29.5	23.4	15.5	11.9
28	24.9	20.3	13.2	9.9
36	18.7	17.7	11.7	8.7
44	13.5	13.8	10.6	7.8
50	10.7	11.0	9.8	7.3
55		9.0	9.5	6.9
60			8.0	6.7
65				6.6

Hauptausleger 56 m

Radius	Nadellänge (m)			
	11	17	20	26
(m)	t	t	t	t
9.6	35.5			
14	32.8	21.2		
16	31.3	20.4	17.4	
19	29.1	19.1	16.5	11.7
24	26.6	17.2	14.8	10.8
32	21.9	15.0	13.0	9.5
40	15.3	13.5	11.7	8.5
48	11.0	11.7	10.8	7.7
60	6.7	7.3	7.6	6.9
65		5.9	6.2	6.6
70			4.9	5.4
75				4.3

Hauptausleger 62 m

Radius	Nadellänge (m)			
	11	14	20	26
(m)	t	t	t	t
9.8	33.0			
12	32.1	26.7		
16	29.1	24.8	17.2	
19	26.9	23.3	16.5	11.6
24	24.1	20.8	15.1	10.9
32	21.4	18.7	13.2	9.6
40	15.0	15.4	12.0	8.6
48	10.7	11.0	11.0	7.9
65	5.1	5.3	5.8	6.3
70		4.1	4.7	5.1
75			3.6	4.0
80				3.1

Hauptausleger 68 m

Radius	Nadellänge (m)			
	11	14	20	26
(m)	t	t	t	t
10	30.2			
12	29.7	25.2		
16	26.4	23.7	16.9	
20	23.5	21.5	16.0	11.5
24	21.0	19.4	14.9	11.0
28	19.7	18.0	14.0	10.3
36	17.4	16.3	12.6	9.3
44	12.3	12.6	11.5	8.4
55	7.6	7.9	8.5	7.6
70	3.6	3.9	4.4	4.8
75		2.8	3.3	3.8
80			2.4	2.8

Hauptausleger 74 m

Radius	Nadellänge (m)			
	11	14	20	23
(m)	t	t	t	t
10.2	26.3			
13	25.1	22.7		
16	22.7	21.3	16.3	
18	21.3	20.1	16.2	13.5
20	20.2	19.0	15.6	13.3
24	18.0	17.3	14.4	12.5
28	16.7	16.0	13.5	11.9
36	15.5	14.6	12.3	10.8
44	11.9	12.2	11.4	9.8
55	7.2	7.6	8.2	8.5
75	2.3	2.5	3.0	3.2
80			2.1	2.3

Hauptausleger 77 m

Radius	Nadellänge (m)			
	11	14	17	
(m)	t	t	t	
10.3	24.2			
13	23.3	21.0		
14	22.4	21.0	18.5	
16	21.0	19.8	18.5	
18	19.8	18.7	17.6	
20	18.8	17.6	16.8	
24	16.8	16.1	15.3	
28	15.6	15.0	14.4	
36	14.5	13.8	13.2	
44	11.6	11.9	12.2	
55	7.1	7.4	7.8	
75	2.2	2.4	2.6	

TLT 10576478 - M00000

Traglasten in Tonnen mit feststehendem Nadelausleger (No. 1008.xx), 82.3 Ballast + 36 t Zentralballast. Oben angeführte Traglastwerte sind nur zur Information. Für Ihren aktuellen Hub verwenden Sie bitte die Traglastwerte aus dem Traglasttabellenbuch.

Notizen

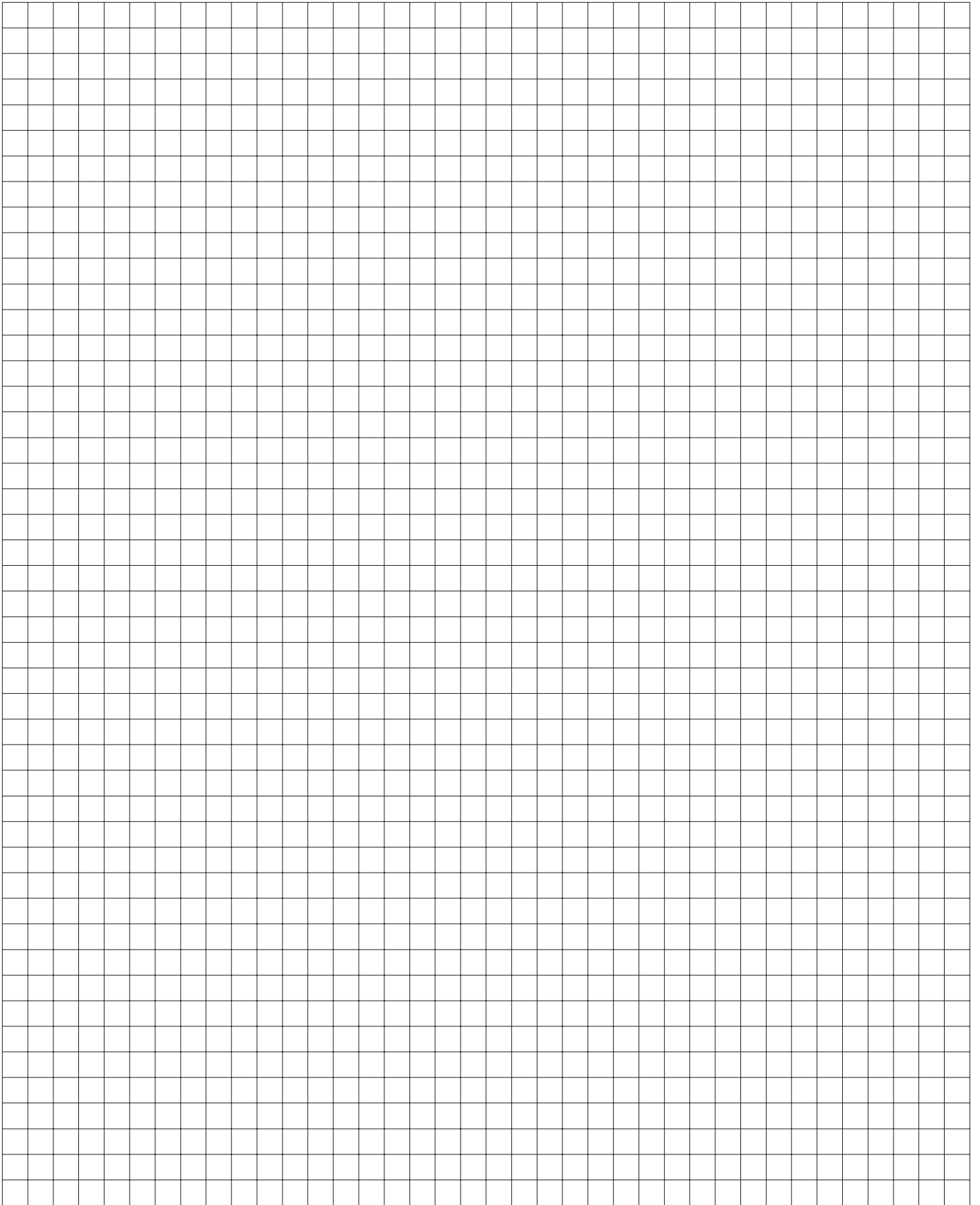

Liebherr-Werk Nenzing GmbH

Dr. Hans Liebherr Str. 1, 6710 Nenzing/Austria
Tel.: +43 50809 41-473, Fax: +43 50809 41-499
crawler.crane@liebherr.com, www.liebherr.com
facebook.com/LiebherrConstruction